

Air Force Institute of Technology

AFIT Scholar

Theses and Dissertations

Student Graduate Works

9-2021

Interdependent Infrastructure Recovery Using Multilayered Networks and Optimization

Brigham A. Moore

Follow this and additional works at: <https://scholar.afit.edu/etd>



Part of the [Infrastructure Commons](#), and the [Systems Engineering Commons](#)

Recommended Citation

Moore, Brigham A., "Interdependent Infrastructure Recovery Using Multilayered Networks and Optimization" (2021). *Theses and Dissertations*. 5088.

<https://scholar.afit.edu/etd/5088>

This Dissertation is brought to you for free and open access by the Student Graduate Works at AFIT Scholar. It has been accepted for inclusion in Theses and Dissertations by an authorized administrator of AFIT Scholar. For more information, please contact richard.mansfield@afit.edu.



**INTERDEPENDENT INFRASTRUCTURE RECOVERY USING
MULTILAYERED NETWORKS AND OPTIMIZATION**

DISSERTATION

Brigham A. Moore, Major, USAF
AFIT-ENV-DS-21-S-077

**DEPARTMENT OF THE AIR FORCE
AIR UNIVERSITY**

AIR FORCE INSTITUTE OF TECHNOLOGY

Wright-Patterson Air Force Base, Ohio

DISTRIBUTION STATEMENT A. APPROVED FOR PUBLIC RELEASE;
DISTRIBUTION UNLIMITED.

The views expressed in this dissertation are those of the authors and do not reflect the official policy or position of the United States Air Force, the Department of Defense, or the United States Government.

This material is declared a work of the U.S. Government and is not subject to copyright protection in the United States.

AFIT-ENV-DS-21-S-077

INTERDEPENDENT INFRASTRUCTURE RECOVERY USING
MULTILAYERED NETWORKS AND OPTIMIZATION

DISSERTATION

Presented to the Faculty

Graduate School of Engineering and Management

Air Force Institute of Technology

Air University

Air Education and Training Command

In Partial Fulfillment of the Requirements for the

Degree of Doctor of Philosophy

Brigham A. Moore, P.E., BS, MS

Major, USAF

August 2021

DISTRIBUTION STATEMENT A. APPROVED FOR PUBLIC RELEASE;
DISTRIBUTION UNLIMITED.

AFIT-ENV-DS-21-S-077

INTERDEPENDENT INFRASTRUCTURE RECOVERY USING
MULTILAYERED NETWORKS AND OPTIMIZATION

Brigham A. Moore, P.E., BS, MS
Major, USAF

Committee Membership:

David R. Jacques, PhD
Chairman

Ramana Grandhi, PhD
Member

Lt Col Steven J. Schuldt, PhD
Member

ADEDJI B. BADIRU, PhD
Dean, Graduate School of Engineering and Management

Abstract

Interdependent infrastructure recovery modeling and simulation are complicated due to various interdependent connections and complexities. Current efforts have identified both operational and restoration interdependency subtypes and coupling strategies that have not been integrated into one comprehensive model. This research presents a model that simultaneously integrates nine interdependency subtypes and four coupling strategies in a multi-objective format to provide the most tailorable and comprehensive network-based recovery model available. This research also created a defense-centric interdependent infrastructure database by modifying the existing CustomizabLe ARTificial Community (CLARC) database. This research then addressed assumptions regarding recovery work management in order to address the impact of work crew structure and training's impact on cost, recovery time, and system operability. These efforts were accomplished by creating mixed-integer programs and then testing them with the defense-centric infrastructure database with a simulated flood event. The results of the scenario showed that exclusion of certain interdependencies could cost over \$4M additional for marginal improvement in infrastructure operability. Additionally, it was shown that using interdependent relationships can be used to overcome inaccessible infrastructure data. Finally, the results showed that team composition can influence recovery cost, time, and operability both negatively and positively. These models benefit emergency managers and infrastructure owners alike.

AFIT-ENV-DS-21-S-077

Dedicated to my God, my wife, my children, and my country.

Acknowledgments

I would like to thank every single one of my professors. I received world class education at their hands. I was challenged to think, grow, and expand in areas and in ways I had not previously considered. I likewise would like to thank all of my classmates, who provided diverse opinions, critical insight, and welcome conversations.

The primary thanks for the present research really rests with each one of my dissertation committee members. Each one played a vital role in mentoring me, challenging me, and asking thought provoking questions that made this research far better than any personal effort ever could. From professional instruction during classes to off-topic discussions about things as casual as the weather Dr. David Jacques, Dr. Raman Grandhi, and Lt Col Steven Schuldt have earned my deepest respect and gratitude.

I would like to thank a couple of additional key individuals who mentored or helped shape this research. First, Lt Col Andrew Hoisington, who explored some early topics and helped shape my research into a manageable quantity. Second, Dr. Brian Lunday, who introduced me to the world of mathematical programming and network science. He also provided key touchpoints in terms of GAMS coding, mathematical formulations, and invaluable mentorship along the way.

I would like to thank a few of my peers. I would like to thank Lt Col Ben Knost and Major Craig Poulin for great friendship and being a wonderful sounding board, even though they were not at the Air Force Institute of Technology with me in person. I also would like to thank Capt Brian Frandsen and his family, who became amazing friends and a constant source of encouragement as we trudged through our research together.

Lastly, I would like to thank my God and my family. I felt encouragement and unfailing support from both places. I often hit dead ends and felt inspiration on how to proceed. My wonderful wife provided unfailing support and lovingly wrangled our little ones while I was preoccupied with research. My gratitude for her and our amazing children is hard to express in words. Thank you everyone!

Table of Contents

	Page
Abstract.....	iv
Acknowledgments.....	vi
List of Figures.....	x
List of Tables.....	xii
I. Introduction.....	1
Research Motivation.....	3
Problem Statement.....	4
Research Objective.....	5
Brief Overview of Methodology.....	5
Assumptions and Limitations.....	7
Key Contributions.....	7
Document Outline.....	8
II. Literature Review.....	9
Defining Interdependencies and Coupling Strategies.....	9
Modeling Interdependent Infrastructure Recovery.....	19
Characterization of Recovery Operations.....	34
Interdependent Infrastructure Model Data and Validation.....	42
Summary of Literature Review.....	44
III. The Customizable Artificial Community (CLARC) Database.....	45
Introduction.....	45
Corrections to Use the CLARC Database.....	46
Concerns and Suggested Improvements in Using CLARC Database in Modeling and Simulation.....	48
Conclusion.....	51
IV. The Lite Base Interdependent Infrastructure Recovery Model (LiteBIIRM).....	52
Introduction.....	52
Literature Review.....	53
Methodology.....	56
Results and Discussion.....	65
Conclusion.....	73

V. The Base Interdependent Infrastructure Recovery Model (BIIRM)	74
Introduction	74
Literature Review	76
Notation and Formulation of the BIIRM	83
Computational Results	97
Conclusions	107
VI. The Flexible Team Base Interdependent Infrastructure Recovery Model (tmBIIRM)	109
Introduction	109
Literature Review	111
Methodology	115
Computational Results	133
Conclusions	141
VII. Model Behavior, Performance, and Limitations	143
Introduction	143
Model Behavior	143
Model Performance	161
Model Limitations	166
Conclusions	169
VIII. Conclusions and Recommendations	171
Introduction	171
Review of Research Objectives	171
Research Conclusions and Contributions	173
Recommendations for Future Research	177
Appendix A. Network Database Preparation for BIIRM	180
CLARC Database	180
Modifications of the Database for the BIIRM	193
Addition of Cost Data	205
Summary of Changes	218
Appendix B. Interdependent Infrastructure Recovery Model Reviews	219
Inclusion Criteria, Category Definitions, and Subcategory Definitions	219
Model Evaluations	226

Appendix C. The Lite Base Interdependent Infrastructure Recovery Model (LiteBIIRM)	234
LiteBIIRM Goals	234
LiteBIIRM Assumptions.....	234
LiteBIIRM Notation.....	235
LiteBIIRM Formulation.....	237
Appendix D. The Base Interdependent Infrastructure Recovery Model (BIIRM)	241
BIIRM Goals.....	241
BIIRM Assumptions	241
BIIRM Notation	245
BIIRM Formulation	247
Appendix E. The Flexible Team Base Interdependent Infrastructure Recovery Model (tmBIIRM).....	255
tmBIIRM Goals	255
tmBIIRM Assumptions.....	256
tmBIIRM Notation.....	258
tmBIIRM Formulation	262
Bibliography	270

List of Figures

Figure	Page
2.1. Some examples of interdependencies, which establish a two-way connection between systems either directly or through other systems (Rinaldi et al. 2001)	10
2.2. Ouyang's (2014) assessment of interdependency subtype definitions showed that Rinaldi et al.'s (2001) definition could classify all interdependent relationships considered with 60% classified as the logical interdependency subtype	13
2.3. Precedence diagrams for four of the six restoration interdependency subtypes	16
4.1. Illustration of one2one coupling between two infrastructures k and \tilde{k}	60
4.2. Illustration of one2any coupling between two infrastructures k and \tilde{k}	60
4.3. Illustration of one2all coupling between two infrastructures k and \tilde{k}	61
4.4. Illustration of one2many coupling between two infrastructures k and \tilde{k}	61
4.5. Partial data simulation with additional interdependencies showed similar results in the operability of a system during recovery operations	70
5.1. The convex combination of cost and operability highlights diminishing returns above a certain operability threshold	103
5.2. Cost differences based on the restoration interdependencies involved where TP, EP, OP, and TS along with TP, EP, and OP represent the assumed closest to reality....	105
5.3. Percent operability of various simulations based on restoration interdependencies included where the simulation with TP, EP, OP, and TS represents the assumed reality; (a) overview of time periods 1 to 12; (b) enlarged analysis of time periods 5 to 12; (c) enlarged analysis of time periods 1 to 4	107
6.1. Flattened representation of the simulated military network and targeted disruptions with both kinetic and cyber-attacks as represented in Scenario 1	134
6.2. Comparison of flexible teaming and parallel teaming infrastructure recovery based on a min and max level of damage evaluated within the same damage scenario	139
6.3. Percent usage of skill per employee as they are grouped by craft	140
6.4. Optimal assignment showed slight preference for intermediate skill level	141
7.1. Objective function analysis minimizing Cost (A) and constraining Time (B)	150
7.2. Objective function analysis minimizing Cost (A) and constraining Disruption (C).....	151
7.3. Objective function analysis minimizing Time (B) and constraining Cost (A)	152
7.4. Objective function analysis minimizing Time (B) and constraining Disruption (C)	153
7.5. Objective function analysis as RMIP minimizing Disruption (C) and constraining Cost (A).....	154
7.6. Objective function analysis as RMIP minimizing Disruption (C) and constraining Time (B)	154

7.7. Convex combination of the cost objective function and the operability objective function.....	157
7.8. Disparity between the RMIP and MIP existed in the terminal operability as well as an increasing disparity in the cost	158
7.9. An example of a partial assignment, α , at time period 1, and summing over eight time periods as the repaired variable, β	160
7.10. The addition of RMIP constraints corrects the initial operability disparity and maintains the cost disparity rather than increasing it	161
7.11. Computational time experienced polynomial growth with some anomalies as the number of time periods being evaluated increased	163
7.12. A series of convex combinations with varying relative optimality gaps	166
7.13. The BIIRM represents a complex multilayered construct using a multi-plex structure to evaluate operational interdependencies and a multi-slice structure to evaluate restoration interdependencies.....	168
A.1. Reconfiguring the ICT network in standard supply-demand construct emphasizes the connectivity and meeting demand of all demand nodes rather than focusing on the origin-destination path.....	191
A.2. Use of color coding for demand (red), transshipment (yellow), or supply (green) function provides visual method for understanding whether or not operational interdependencies are likely	198

List of Tables

Table	Page
2.1. Description and examples of operational interdependency subtypes	12
2.2. Description and examples of restoration interdependency subtypes	15
2.3. Description of coupling characterizations and associated system response	17
2.4. Network-based models have gaps in organizational structure associated with recovery, need improvement to accessible data sources, and can model multiple interdependency types and states of the system (adapted from Ouyand 2014).....	24
2.5. Description of inclusion criteria that is used to classify models as network-based interdependent infrastructure recovery (IIR) models	27
2.6. Matrix of IIR models compared to cost, time, and operability objectives.....	37
2.7. Indication of which IIR models challenged characterizing assumptions.....	41
3.1. Explanation of data inconsistencies found in CLARC Database.....	46
3.2. Summary of 322 data errors found in CLARC Database	47
3.3. 34 nodal assets have day-to-day and emergency telecommunication requirements not captured in the original dataset.....	49
3.4. Suggested <i>Communication</i> and <i>People</i> demand data by node type.....	50
4.1. General notation for the MIP comprising sets, variables, and parameters for flow, scheduling, and cost.....	57
4.2. Interdependency coupling strategies ξ affects the interdependency parameter $\gamma_{ii\psi\xi t}^{k\bar{k}}$ by changing possible values	62
4.3. The full dataset represents more nodes and arcs, while the partial dataset represents more interdependency relationships	68
5.1. No model currently addresses the three most common objectives and all operational and restoration interdependency subtypes.....	81
5.2. The BIIRM dataset with reflected and new nodes and arcs due to increased communication infrastructure data	99
5.3. Multiple operational interdependency subtype relationships across all infrastructure systems are incorporated into the BIIRM dataset.....	100
5.4. Nodes and arcs across all infrastructure systems are damaged in a simulated flood event	100
5.5. All infrastructure systems are involved across all five of the restoration interdependency subtypes over 36 restoration activities (approx. 50% of damaged assets)	101
5.6. Exclusion of cber and logical interdependency subtypes can overestimate operability projections	104
6.1. Sets, parameters, and variables associated with network flow and network	118
6.2. Sets, parameters, and variables associated with scheduling workers and repairing infrastructure systems	119

6.3. Sets, parameters, and variables associated with operational and restoration interdependencies	126
6.4. Effect of coupling strategy $\xi \in \Xi$ on operational interdependency parameter $\gamma_{it\psi\xi t}^{kk}$ given some sort of node-to-node parent-child relationship	127
6.5. Network and damage scenario characteristics within simulated network	134
6.6. Number and type of interdependency relationships within the network	135
6.7. Worker crafts and associated primary, secondary, and tertiary skills.....	136
7.1. Goals and variables for the cost, time, and disruption objective functions	148
7.2. Objective function analysis by minimizing one function, constraining another, and allowing the third to be free.....	149
7.3. Goals and variables for the cost, operability, and time objective functions used in the LiteBIIRM, BIIRM, and tmBIIRM	156
7.4. Range of computational time and average time for solving the same problem with different specified optimality gaps	165
A.1. CLARC Database represents a large interdependent network consisting of nodes and arcs across five principal infrastructure systems (i.e., power, telecommunications, water, wastewater, and TER) and five additional layers	181
A.2. CLARC Database exemplifies infrastructure interdependencies between all the network layers	182
A.3. 34 nodal assets have day-to-day and emergency telecommunication requirements not captured in the original dataset.....	187
A.4. Additional ICT & TER demand data required for BIIRM analysis.....	192
A.5. CLARC node mapping to BIIRM infrastructure layers and commodities; H – host layer, R – reflected layer	196
A.6. CLARC non-primary node mapping to BIIRM infrastructure layers; H – host layer, R – reflected layer	197
A.7. Multiplex structure adds significant node count as seen in comparison of CLARC, BIIRM Multiplex (MP), and Multiplex Plus (MP+), Multiplex Reduced (MPR), and Multiplex Reduced Plus (MPR+) datasets	200
A.8. Damage scenario created for the BIIRM Multiplex Plus dataset is the only one incorporating all restoration interdependency subtypes of interest.....	203
A.9. BIIRM damage scenario showcases all four coupling strategies possible in restoration interdependencies	203
A.10. The four terrain types used in CLARC Database have site preparation costs ranging from \$1,000 per job to \$3,500 per job.....	207
A.11. Assignment costs for the five infrastructure systems used in the BIIRM range from \$600 to \$2,520 per work crew assignment.....	210
A.12. Relative nodal demand scales and units of measure based on commodity.....	211
A.13. Model demand ranges, average national demand [units/time], and average unit cost [\$/unit] vary across infrastructures and asset sector grouping	213
A.14. Unit costs for TER commodities based on weight.....	217
B.1. Definitions of model evaluation inclusion criteria.....	220

B.2. Description of categories used as adapted from Griot (2010).....	221
B.3. IIR model evaluation subcategories describing general model attributes.....	222
B.4. IIR model evaluation subcategories describing interdependencies and coupling.....	223
B.5. IIR model evaluation subcategories describing mathematical approach, data requirements, advantages, and limitations.....	224
B.6. IIR model evaluation subcategories describing recovery operations.....	225
C.1. Summary of objective function and constraints for LiteBIIRM	240
D.1. Summary of objective function and constraints for BIIRM	254
E.1. Summary of objective function and constraints for tmBIIRM.....	269

INTERDEPENDENT INFRASTRUCTURE RECOVERY USING MULTILAYERED NETWORKS AND OPTIMIZATION

I. Introduction

Built and social infrastructure networks – comprising in part telecommunications, electrical energy, transportation, emergency response services, drinking water, wastewater, and other social services – are a complex system-of-systems or network-of-networks that is foundational to our society (Almoghathawi et al. 2017; Department of Homeland Security 2013). The management of this socio-technical and cyber-physical network-of-networks is complex and makes decisions regarding the supply of public services challenging. One of the primary purposes of built infrastructure is to provide a service at an optimized balance of cost, performance, and risk (Hall et al. 2016). The disruption of these services and the associated recovery of the infrastructure systems is complicated by interdependencies within the underlying infrastructure network-of-networks.

The influence of interdependencies between infrastructure networks has been shown multiple times to affect operations and recovery activities within the last couple of decades. A small sampling of events over the past two decades are sufficient to substantiate this claim. In 2000 to 2001, a disruption in the electrical power grid in California impacted the oil and gas industry, which prolonged disruption in the electrical power network (Fletcher 2001). The September 2001 terrorist attack on the World Trade Center highlighted both physical and non-physical interdependencies with an example of the latter being an administrative policy levied on the aviation infrastructure, which

ultimately resulted in \$1.4 billion lost in revenue due to a three-day airport closure (Faturechi et al. 2014). In 2003, a large scale blackout showed how an initial fault in the power lines combined with a fault in the alarm control system caused cascading failures along the electrical distribution grid resulting in over 50 million people in the United States and Canada without power for up to two days (Minkel 2008). Natural disasters to include the following list have time and again showcased the interdependent nature of built socio-technical and cyber-physical infrastructure networks (Comerio 2014; Givetash 2020; National Infrastructure Advisory Council (NIAC) 2018; Ramirez-Meyers et al. 2021).

- 2005 Hurricane Katrina in Florida and Louisiana
- 2011 Tōhoku earthquake in Japan and subsequent Fukushima nuclear disaster
- 2012 Superstorm Sandy in New Jersey and New York
- 2017 Hurricane Harvey in Texas
- 2017 Hurricane Maria in Puerto Rico
- 2019 to 2020 Australian wildfires
- 2020 wildfires in California
- 2021 freezing temperatures in Texas

Therefore, it is proposed that a better understanding of interdependencies of infrastructure networks will lead to more informed and efficient infrastructure recovery.

The focus of this research is to create a multi-objective interdependent infrastructure recovery model. This model seeks to balance competing objectives of minimizing recovery costs, repair time, and disruption to services. These three objectives – cost, repair time, and operability – create an infrastructure recovery trilemma. This

recovery trilemma has parallels to the infrastructure operations trilemma of cost, performance, and risk, as well as the construction trilemma of cost, quality, and speed. This model also seeks to simultaneously integrate nine interdependency subtypes and four coupling strategies to more accurately evaluate real, complex, and interdependent infrastructure relationships. The intent of the model is to support decision making by emergency managers and asset owners during recovery operations.

The remainder of this chapter provides the motivation for this research, defines the problem statement, and lists the corresponding research objective and questions. A brief overview follows, explaining the methodology used, the limitations of the modeling efforts, and the key contributions of the present work. The final section in this chapter outlines the rest of the document.

1.1. Research Motivation.

The general motivation for research to develop an interdependent infrastructure recovery model is to improve the resilience of the underlying network-of-networks. Resilience of interdependent infrastructure networks is an emerging field with various definitions, approaches, and methods (Attho-Okine 2016). The resilience of infrastructure networks typically is defined as a network's ability to withstand, adapt to, and recover from a disruption (Barker et al. 2017). This full-breadth definition of resilience is often segmented into the vulnerability and recoverability aspects of resilience (Almoghathawi et al. 2017). The focus of this work is on the recoverability aspect of resilience.

The specific motivation for seeking to enhance resilience through an evaluation of interdependent infrastructure recovery stems from three primary sources. First, disruptive events involving interdependent infrastructure networks are unique and some

interdependencies only manifest themselves during the recovery operations (Sharkey et al. 2016). Therefore, not focusing on recovery operations would preclude analysis of certain interdependencies. Second, the underlying interdependencies of infrastructure networks make overall systems complex and vulnerable to cascading and escalating failures (Buldyrev et al. 2010; Rinaldi et al. 2001). These issues of complexity and vulnerability are primary reasons recovery after disaster or disruption is still an open question and an issue worth evaluating (National Infrastructure Advisory Council (NIAC) 2018). Third, certain defense elements within our nation have identified resilient infrastructure as critical in today's complex security environment (Department of Homeland Security 2013; United States Department of Defense 2018, 2019). This has led to a desire by the United States Air Force to seek for more resilient infrastructure solutions (Headquarters United States Air Force 2019). The combined elements of the unique nature of interdependencies during recovery, the lack of current solutions to solve these complex problems, and the national security imperative make this research important and relevant.

1.2. Problem Statement

No interdependent infrastructure recovery model has sought to integrate all known interdependency subtypes and coupling strategies within a single multi-objective model. Furthermore, interdependent infrastructure recovery models have not been defense-focused, which has often led to assumptions that may be irrelevant or inappropriate for defense recovery operations.

1.3. Research Objective

The primary research objective is to develop a defense-focused interdependent infrastructure recovery model that will balance cost, repair time, and operability when presenting recovery strategies. This model incorporates multiple objectives, operational interdependencies, restoration interdependencies, and recovery operations constraints. The goal in developing this type of model is to increase resilience of interdependent infrastructure networks by focusing on the recovery aspects of resilience.

The following are investigative questions, which have guided this research and have made the desired research objective attainable.

1. How can multiple and various interdependency subtypes and coupling strategies be simultaneously incorporated into an interdependent infrastructure recovery model?
2. How do multiple and various interdependency subtypes and coupling strategies affect the cost, repair time, and operability of disrupted infrastructure networks?
3. How does work crew management including flexible team composition, training, and education of recovery personnel affect the recovery of interdependent infrastructure networks?

1.4. Brief Overview of Methodology

This section briefly describes the model development based on integrating several different components. Then it describes the modification and use of an interdependent infrastructure database to provide a relevant defense-focused application. Finally, it describes the modification of the original model to incorporate work crew management's effect on recovery operations.

Previous work has identified multiple operational interdependency subtypes to include physical, cyber, geospatial, and logical (Rinaldi et al. 2001). Additionally, a distinction has been made between operational interdependencies and restoration interdependencies, which comprise at least five additional subtypes (Sharkey et al. 2016). Furthermore, four coupling strategies have been identified that impact whether or not a dependent node or arc is operable based on various conditions (González et al. 2016). A network-based multi-objective mixed-integer program (MIP) that combines elements of both network design problems and scheduling problems is presented as an effective model for recovery operations.

The CustomizabLe ARtificial Community (CLARC) Database is a regional-sized dataset exhibiting over 2,600 network-to-network interdependencies between 5 civil and 5 social infrastructure networks (Sharkey et al. 2018). This dataset was reduced to approximately 10% and constructed as a multiplex network-of-networks. This reduced dataset approximates the size of a medium to large Air Force Installation. A simulated flood event damaging 5-7 % of infrastructure systems was used to evaluate the effect of operational and restoration interdependencies and coupling strategies on cost, repair time, and operability.

Most current infrastructure restoration models typically use parallel teams or infrastructure-specific teams to model recovery work crews. A unique formulation of the original MIP presented in this work was modified to allow for flexible teaming structures and various skill-levels. This model allows for unbalanced teams, the concept of massing, and creates a preemptive environment. All of these elements are able to affect recovery operations.

1.5. Assumptions and Limitations

Infrastructure networks are not all designed, constructed, or operated uniformly. This means that interdependencies among infrastructure networks will be different based on every unique set of infrastructure networks, albeit some commonalities may also exist. Therefore, modeled interdependencies hold only for the specific scenario and set of networks modeled and cannot generally be extended to effects that would be repeated in all systems that contain the modeled infrastructure systems. However, the capability to model complex interdependent infrastructure networks is extendable to all similar modeling and simulation efforts.

The use of a network-based model assumes all commodities within a given infrastructure flow similarly, which is contrary to the physics of certain systems. However, the use of network flow models in particular have been used as a reasonable representation of infrastructure networks and provide a sufficient balance between model complexity and reality (Cavdaroglu et al. 2013; Nurre et al. 2012). Other specific modeling assumptions and limitations are addressed in the applicable chapters discussing the models or in the associated appendices.

1.6. Key Contributions

This research contributes to the interdependent infrastructure recovery body of knowledge in the following ways:

1. Provide a defense-centric dataset for analysis of recovery models dealing with interdependent infrastructure systems;
2. Novel use of network-to-network interdependencies and coupling strategies to overcome inaccessible infrastructure data;

3. Novel interdependent infrastructure recovery model incorporating multiple interdependency types and multiple coupling strategies; and
4. Novel extension of the base interdependent infrastructure recovery model by relaxing prevalent assumptions concerning work crew management.

1.7. Document Outline

The remainder of this document is broken into several chapters. Chapter 2 details the relevant literature regarding interdependency subtypes, coupling, and previous modeling efforts. Chapter 3 explains the database used, the errors found, and the concerns that were addressed in the modified version. Chapter 4 presents an abbreviated version of the base model that highlights how coupling strategies can help overcome missing infrastructure data. Chapter 5 presents the base model, which integrates 9 interdependency subtypes uses the modified database to evaluate the effect of interdependencies. Chapter 6 presents an extension to the base model by changing underlying assumptions about the how recovery work crews are managed. Chapter 7 explores the boundaries and limitations of the models created in this research. Chapter 8 concludes this present work and identifies future work.

II. Literature Review

This chapter summarizes relevant literature and the progress made thus far in interdependent infrastructure recovery (IIR) modeling. The first section goes over definitions and terms used throughout this document to include dependency, interdependency, interdependency subtypes, and coupling strategies. The next section details modeling efforts encompassing interdependent infrastructures in general and then focuses on network-based IIR modeling. The third section provides a synthesis of key characterizations of IIR modeling. The last section discusses data access and availability.

2.1. Defining Interdependencies and Coupling Strategies

Interdependencies and coupling strategies are fundamental concepts of the present work. The first subsection discusses the differences between dependency and interdependency. The second subsection details the two main types of interdependencies used in this present work – operational and restoration – and then explains 10 different subtypes. The third subsection summarizes multiple coupling characterizations and then four different coupling strategies employed in this research.

2.1.1. *Dependency vs. interdependency*

Rinaldi et al. (2001) made a clear distinction between dependence and interdependence. Dependence means that an infrastructure relies on goods or services from another infrastructure system. Electrical power systems provide an example of dependencies under normal operating conditions. The electrical power system relies on transportation infrastructure for petroleum product delivery, it relies on telecommunication infrastructure for Supervisory Control and Data Acquisition (SCADA) management, and it relies on water infrastructure for emissions control and

cooling. The transportation, telecommunication, and water infrastructures, in turn, rely on the power system infrastructure for traffic management, information system operation, and water distribution, respectively. This mutual dependency creates an interdependency or a bi-directional dependency between two infrastructure systems (Figure 2.1).

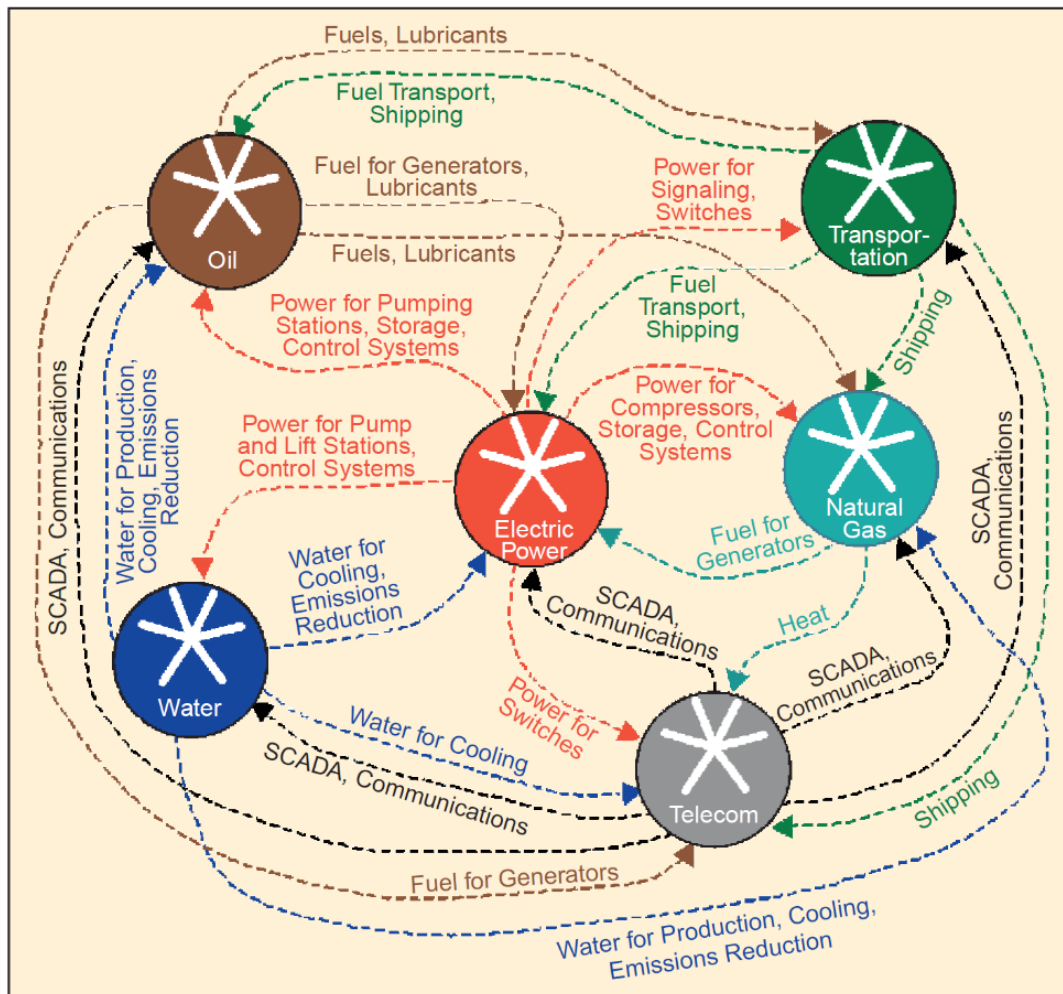

Fig. 2.1. Some examples of interdependencies, which establish a two-way connection between systems either directly or through other systems (Rinaldi et al. 2001)

Some interdependencies are direct relationships and others are indirect relationships. An example of an indirect interdependency is illustrated in Figure 2.1

between the water and oil infrastructures. The oil infrastructure depends on the water infrastructure for oil and lubricant production and environmental management during the production process. The water infrastructure does not directly depend on the oil infrastructure, but does depend on both the electric power and telecommunication infrastructures which depend on the oil infrastructure. Therefore, an indirect interdependency exists between oil and water infrastructures.

Another definition of interdependency stems from the distinction between the prefixes *intra* and *inter*, meaning within and between, respectively (Merriam-Webster.com 2021). The presence of a connection does not immediately form an interdependence. Rather two infrastructure systems are interdependent if and only if the state of each is dependent on the other (Rinaldi et al. 2001). Therefore, a strategy employed by many when capturing any type of interdependence is to capture all dependencies between components of infrastructure systems (Almoghathawi et al. 2019; Cavdaroglu et al. 2013; González et al. 2016; Lee et al. 2007; Sharkey et al. 2015). By capturing all dependent relationships between infrastructure systems, all interdependent relationships are also captured. This more generalized interdependency definition of dependence between systems ensures that all direct and indirect interrelationships are included. This is the definition used in the present research.

2.1.2. Types and subtypes of interdependency

Two primary categorizations of interdependency types are used – operational and restoration. Rinaldi et al. (2001) suggested that interdependencies vary widely from system to system, but that there were four different subtypes of operational interdependencies to include physical, cyber, geospatial, and logical. Sharkey et al.

(2016) claimed there were at least five different restoration interdependency subtypes impacting system recovery to include traditional, effectiveness, and options precedence, time-sensitive options, and resource competition. González et al. (2016) also highlighted a uniquely restorative aspect of the geospatial interdependence subtype, which is called geospatial repair. Table 2.1 provides a description and an example of each operational interdependency subtype as established by Rinaldi et al. (2001)

Table 2.1. Description and examples of operational interdependency subtypes

Subtype	Description	Example
Physical	One system's output is another system's input and is established by flow of commodities or materials.	Electricity from the electrical power network supplying power to a pump in the water network, which is used to distribute water in the water network.
Cyber	The state of an infrastructure system depends on information, which is transmitted through the telecommunication infrastructure.	SCADA systems controlling the natural gas and electrical power grid which send information through the telecommunication infrastructure to alter the flow of natural gas to meet electrical power production demand.
Geospatial	Based on physical proximity and occurs when a local event can cause a change in the state across all infrastructure systems.	A power line and communication line are strung under a bridge and the disaster on the bridge could cause effects in all systems (Kennedy 2003).
Logical	An interdependent relationship between two systems that is not physical, cyber, or geographical (e.g., control schema ^a , economic influences ^b , societal and policy influences ^c).	A national security incident involving the aviation industry, which caused a policy that shut down airport traffic for multiple days (Faturechi et al. 2014).

^a See Rinaldi et al. (2001); ^b see Zhang et al. (2018); ^c see Pederson et al. (2006)

As mentioned previously, these four operational interdependency subtypes are not the only operational interdependency subtypes listed in the literature. Ouyang (2014) compiled five different lists of interdependency subtype definitions from literature. Ouyang then used ten emergency events that exhibited interdependencies between systems from historical disasters to assess the interdependency definitions. According to Ouyang’s assessment, only Rinaldi et al.’s (2001) definitions could be used to classify all ten interdependency relationship examples. Three of the six definition lists could classify 70% of the emergency events and one list could classify only 40%. Figure 2.2 illustrates how Rinaldi et al.’s framework was able to classify all the events exhibiting interdependent relationships; however, 60% of the events were classified by the catch-all *logical* interdependency subtype. This shows that although Rinaldi et al.’s framework is sufficient, a large portion of interdependent manifestations in a network fall under the logical interdependency subtype.

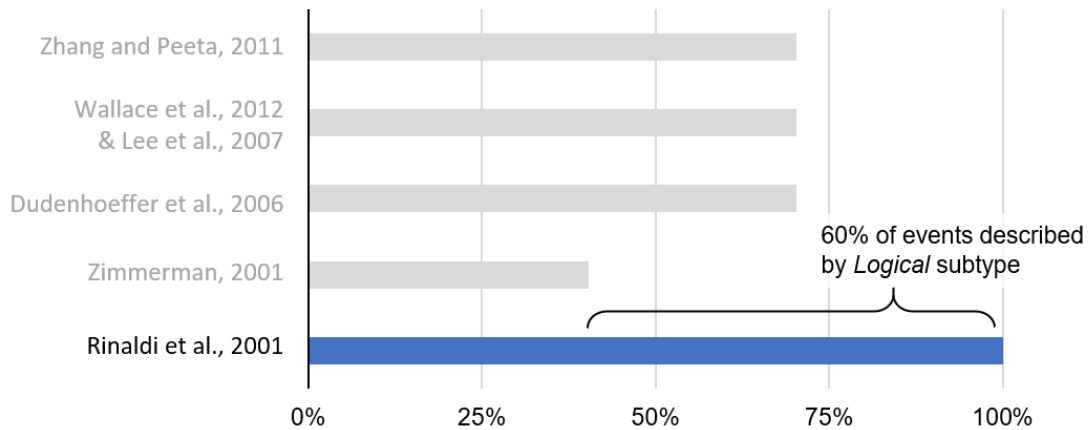

Fig. 2.2. Ouyang’s (2014) assessment of interdependency subtype definitions showed that Rinaldi et al.’s (2001) definition could classify all interdependent relationships considered with 60% classified as the logical interdependency subtype

Of particular interest to the present work are the interdependencies that only appear during the restoration of the disruptive event (Ouyang 2014; Sharkey et al. 2015, 2016). Table 2.2 provides a description and an example of each restoration interdependency subtype. Figure 2.3 illustrates the four precedence relationships (i.e., traditional precedence, effectiveness precedence, options precedence, and time-sensitive options) described in Table 2.2.

In sum, by combining operational interdependency subtypes from Rinaldi et al. (2001) and restoration interdependency subtypes from Sharkey et al. (2015, 2016) and González et al. (2016), a more comprehensive IIR model can be established. This results in a total of ten interdependency subtypes. No model to-date has incorporated all of these interdependency subtypes within a single model, though some existing models could handle some of the different interdependency subtypes with some modifications or additional sets of constraints (González et al. 2016).

Table 2.2. Description and examples of restoration interdependency subtypes

Subtype	Description	Example
Traditional precedence	A restoration task in system <i>B</i> cannot take place until a restoration task in system <i>A</i> is completed. This happens typically because either 1) system <i>B</i> requires the restoration of the service from <i>A</i> or 2) the task in system <i>A</i> prevents the task in system <i>B</i> from starting.	Case 1 is when power needs to be restored in order to test a piece of equipment that went down. Case 2 is when downed power lines need to be cleared before debris from an obstructed roadway can be cleared.
Effectiveness precedence	A restoration task in system <i>B</i> is not as effective until a restoration task in system <i>A</i> is accomplished. This could mean a longer processing time or more resources are needed to accomplish it.	Restoring power to a nearby pumping station in order to remove excess water from a flooded street. The alternate execution is with small pump trucks with lower flowrate and lower capacity.
Options precedence	A service can be restored in system <i>B</i> as long as one of many possible solutions in some other system (e.g., system <i>A</i> , <i>C</i> , etc.) is restored.	A facility may continue to operate if either the power is restored or a generator is installed.
Time-sensitive options	A restoration task in system <i>A</i> must be performed by a certain deadline. If the restoration task in system <i>A</i> is not or will not be completed by that deadline then a new task, say in system <i>Z</i> , must be accomplished by that deadline.	Either power needs to be restored by a certain deadline or the generator needs to be refueled on a critical facility.
Resource competition	Any number of systems are in need of shared resources.	Three buildings each in need of a mobile generator and only having one.
Geospatial repair	Two or more restoration tasks are co-located and can share in the burden of site preparation.	Disruption in a water main coincides with road that subsided during an earthquake.

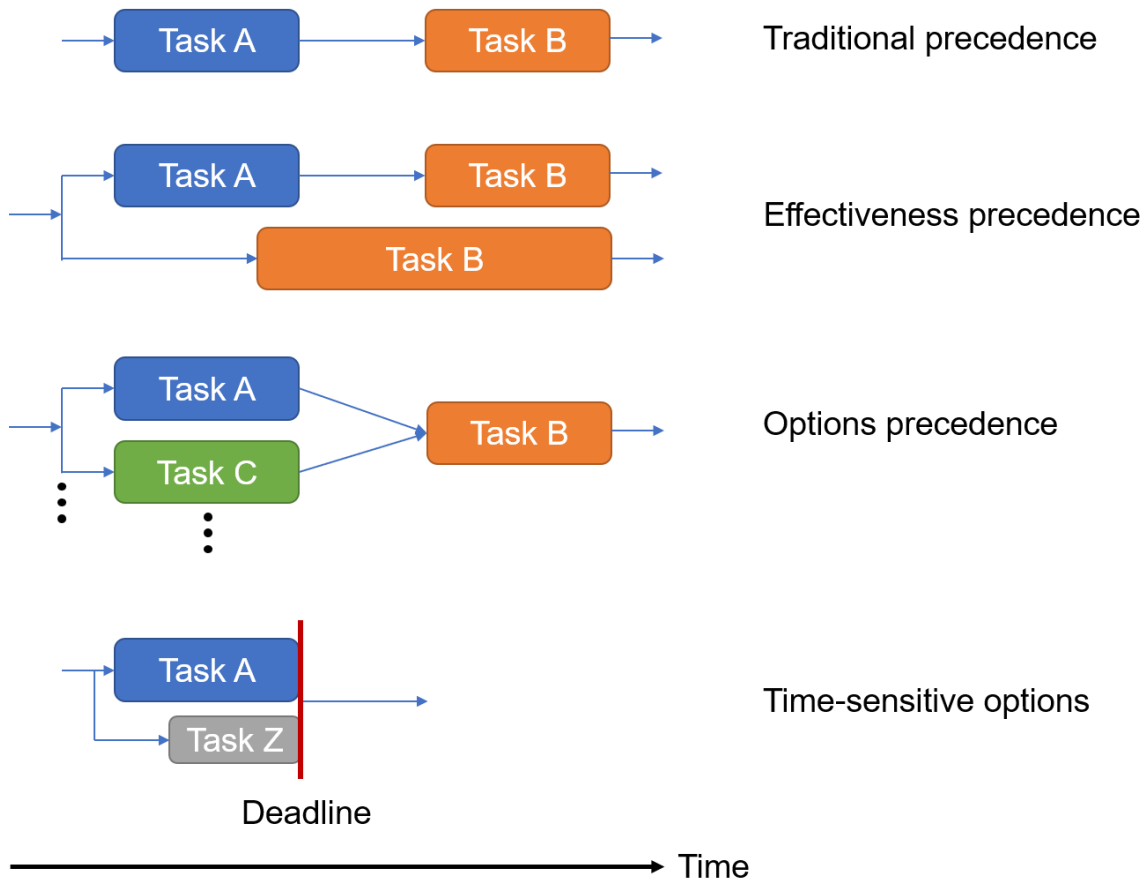

Fig. 2.3. Precedence diagrams for four of the six restoration interdependency subtypes explained in Table 2.2

2.1.3. Coupling strategies

Infrastructure may be coupled or connected in a variety of ways, which will often determine their response. Table 2.3 summarizes several different coupling characterizations and the subsequent interdependent infrastructure response.

Table 2.3. Description of coupling characterizations and associated system response

Coupling Characterization	Description and System Response
Tight or loose ^a (Inflexible or adaptive)	<p>A tight coupling exists when a failure in system <i>A</i> nearly instantly affects system <i>B</i>.</p> <p>A loose coupling exists between systems <i>A</i> and <i>B</i>, when a disruption in one has some degradation in the other. That degradation may be full or partial and delayed or gradual.</p>
Linear or complex ^{a,b,c}	<p>A linear coupling is predictable and manifests a planned response due to design and the absence of feedback loops.</p> <p>A complex coupling is sometimes unpredictable and manifests irregular or unplanned response during normal procedures often due to the presence of feedback loops.</p>
Deterministic or random ^{a,c,d,e,f,g}	<p>A deterministic coupling may be established through consultation with infrastructure managers or designed into the system and elicits a planned response.</p> <p>A random coupling is a fabricated relationship often used due to lack of interdependency data, available infrastructure data, or to generate some network topological configuration.</p>
String or mesh ^d	<p>These couplings are listed as a separate characterization of coupling, but with no description or example given in the literature.</p>

^a See Rinaldi et al. (2001); ^b see Fletcher (2001); ^c see González et al. (2016); ^d see Haimes et al. (2007); ^e see Lee et al. (2007); ^f see Karakoc et al. (2019); ^g see Lewis (2009)

Additional relevant topics introduced by Rinaldi et al. (2001) associated with coupling was the concept of coupling order and nth-order effects. Coupling order indicates whether two infrastructure systems are directly coupled or whether they are coupled through one or more other infrastructure systems. This directly leads to the concept of nth-order effects, which is that disruption between two systems have rippling

or cascading effects into other systems. Cascading effects and failures have been one of the principle thrusts of interdependent infrastructure research (Buldyrev et al. 2010; Chai et al. 2016; Department of Homeland Security 2009; Kong et al. 2019; Loggins and Wallace 2015).

González et al. (2016) provided a mathematical definition for four different linear or deterministic coupling strategies. The authors mentioned these types of coupling can describe node-to-node coupling for all operational interdependency subtypes that behave in the described manner. The authors presented only one coupling strategy combined with only the physical interdependency subtype in their model formulation. All four of these coupling strategies are the ones used in this research and are briefly presented below.

To describe these coupling strategies let there be a set of nodes belonging to a particular infrastructure, denoted as \mathcal{N}^k . Let an interdependent set of nodes belonging to a different infrastructure be denoted as $\mathcal{N}^{\tilde{k}}$. Finally, let there be a node-based component in either system designated as $i \in \mathcal{N}^k$ or $\tilde{i} \in \mathcal{N}^{\tilde{k}}$, representing the parent and child node, respectively. With these things established, González et al. (2016) explained the four coupling strategies as follows:

- Case 1, one-to-one: a component $\tilde{i} \in \mathcal{N}^{\tilde{k}}$ is only functional when a specific singular component $i = i^*$ is functional, where $i^* \in \mathcal{N}^k$.
- Case 2, one-to-any: a component $\tilde{i} \in \mathcal{N}^{\tilde{k}}$ is functional when at least one component of a subset is functional, namely $i \in \mathcal{N}^{*k}$ where $\mathcal{N}^{*k} \subseteq \mathcal{N}^k$.

- Case 3, one-to-all: a component $\tilde{i} \in \mathcal{N}^{\tilde{k}}$ is functional only if every component from a subset, $\mathcal{N}^{*k} \subseteq \mathcal{N}^k$, is functional.
- Case 4, one-to-many: a component $\tilde{i} \in \mathcal{N}^{\tilde{k}}$ depends partially on the functionality of a subset of components, $\mathcal{N}^{*k} \subseteq \mathcal{N}^k$. The dependence on each component $i \in \mathcal{N}^{*k}$ is not necessarily the same. Thus, each node $i \in \mathcal{N}^{*k}$ provides a fraction of the functionality of $\tilde{i} \in \mathcal{N}^{\tilde{k}}$.

While these four coupling strategies do not completely encompass all possibilities, they describe various realistic connections between infrastructure systems. One coupling that seems to be missing is the many-to-many relationship. However, this can be achieved by establishing multiple one-to-many relationships. Further discussion on coupling and its effect on IIR will be presented in Chapter IV.

The presence or absence of various coupling strategies within a network will impact the formulation of an IIR model. No formulation known includes various coupling strategies to be inherent in the formulation. This integration is a necessary complexity to approximate more closely the variety of coupling that exists within real interdependent infrastructure systems.

2.2. Modeling Interdependent Infrastructure Recovery

This section provides a general overview of IIR modeling and simulation efforts. The first subsection discusses the various types of methods used for modeling and simulation of interdependent infrastructure systems in general. The following subsection discusses network-based models. Then the third subsection analyzes IIR models relevant to the present work.

2.2.1. Types of interdependent infrastructure modeling methods

Several reviews of interdependent infrastructure models have been conducted, which highlight several different methods to try and model these complex systems and networks (Eusgeld and Kröger 2008; Griot 2010; Ouyang 2014; Pederson et al. 2006; Satumtira and Dueñas-Osorio 2010). Largely, the various approaches can be categorized as empirical methods, agent-based methods, system dynamics, economic theory, network-based methods, and other methods. Each of these will be briefly summarized.

Empirical methods relate to combing through historical infrastructure failure or disaster data and using data analytics to determine failure patterns and failure indicators. This method then leverages this information to perform risk analysis and forecasting. This approach is typically done at an infrastructure system level with little finer granularity. It is often done by scouring news feeds and reports after a disaster has happened. Ouyang (2014) highlighted three shortfalls of this method including misreporting, no standardized data trying to be collected from event to event, and being very event-dependent. This means there may be issues trying to extrapolate data and information from one disaster to simulate a similar disaster in another area on different networks. Some issues including construction standards and socio-economic imbalance can play into the complexity of trying to use system specific data elsewhere.

Agent-based methods are a bottom-up approach that model both systems and users in the system as agents (Rinaldi et al. 2001). This method is highly promising as a method that can be used to model such complicated networks; however, it comes at a cost of building from the ground up (Pederson et al. 2006; Satumtira and Dueñas-Osorio 2010). A weakness of this method is that every agent has assumptions made about it

regarding the agent's behavior (Ouyang 2014). To compound this problem further, there is often a lack of data to validate the assumptions being made to govern the interactions of the agents.

System dynamics is a top-down approach used at a system-level. It leverages a series of differential equations to describe the system-level behaviors. This has limitations of not being able to evaluate the impact of a component on the system. Some issues identified by Ouyang's (2014) review are the high reliance on subject matter experts, the semi-quantitative nature, the large amounts of data (typically not accessible) for parameter calibration, and conceptual validation.

Economic theory employs either the Leontief's input-output inoperability model or computable-general-equilibrium based methods. The first method adopts a system-scale economic model to determine and assess interdependencies (Haimes et al. 2007). While typically only at a system-level, some application has been made on a community scale with higher granularity (Valencia 2013). A large advantage of this method is the accessibility to data for use in the model. This modeling method has also been used for restoration resource allocation scheduling (Zhang et al. 2018). A major issue with this method is since the interdependency is derived from macro-scale economic data the values in the adjacency matrix only measure interdependency strength during normal operations and are limited, at best, as approximations during recovery and restoration activities (Ouyang 2014). Additionally, when evaluating the strengths and weaknesses of using the computable-general-equilibrium based methods, Ouyang (2014) commented on the lack of substantiating data to derive some of the parameters.

Network-based approaches are a promising area of interdependent infrastructure system modeling. Network-based models are typically either topology-focused or based on a network flow method. A topology focus seeks to evaluate any number of things (e.g., failure propagation, performance, resilience) based on the structure of the network or networks (Lewis 2009). An advantage to this method is there is minimal data requirements, since the networks are typically generated using certain parameters to create random networks with desired attributes. However, a huge limitation is the applicability these models can provide, since they are randomly constructed, which most civil infrastructure networks are not (Ouyang 2014). A network flow method seeks to account for the services flowed by the individual infrastructure systems. This is typically a bottom-up approach and provides insight into component-scale interaction. The downside to component-scale analysis is the level of detail and the amount of data, which is typically sensitive and not easily accessible (Ouyang 2014). Some efforts have been made to make datasets available for interdependency modeling using network flow models, but there are not many (González 2017; Loggins et al. 2013).

Other methods include hierarchal holographic modeling (HHM), high level architecture (HLA), petri nets, dynamic control system theory, and the Bayesian network methods (Ouyang 2014). Haines et al. (2007) provided an example of what an HHM framework would look like, however it is difficult to apply to interdependent infrastructure systems due to complexity, which becomes complicated and infeasible. Eusgeld et al. (2011) produced a layout of a model using HLA methods for a SCADA and other systems under control in a unique coupled or aggregated approach. As noted by Ouyang (2014), HLA is the only method so far that has capability to model the entirety of

the resiliency problem, but has yet to be done. This is due to the fact that the HLA theoretically is a construct that interfaces with various models and is therefore a means to define relationships between various model types (IEEE Computer Society 2010). Petri nets are a four-tuple mapping of places, transitions, inputs, and outputs. It is similar to network models and is sometimes used in conjunction with them (Yianni et al. 2016). Dynamic control systems theory describes infrastructure systems and their interdependencies by the use of transfer functions into a frequency domain and then the interdependency can be computed by the norm. Bayesian networks is based on an acyclic graph which uses arcs as conditional dependencies and nodes as infrastructure systems.

From the two most promising model types (i.e., agent-based models and network-based models), network-based models were selected for this research. A particularly useful analysis completed by Ouyang (2014) developed example resilience strategies and then determined which models were best suited to those strategies from literature. The analysis covered the resistive, absorptive, and restorative capacities of a system. Since the present research deals with recovery from a degraded state, the resilience strategies based on restorative capacity offered an area of potential research. Specifically, network-based flow models were chosen because they offered several desirable traits, including an area of research for improving organizational structure to increase effective restoration activities, the ability to model various interdependency types, and the ability to model multiple states of the system. There is also a need to develop more accessible datasets for network-based modeling purposes, which presents an area for further contribution. Table 2.4 summarizes these desirable attributes of network-based models as adapted from Ouyang (2014).

Table 2.4. Network-based models have gaps in organizational structure associated with recovery, need improvement to accessible data sources, and can model multiple interdependency types and states of the system (adapted from Ouyang 2014)

Restorative resilience strategy with minimal research

Adjust and improve the organizational and administrative structure to accelerate restoration decisions and coordination, such as sharing information among stakeholders, establishing the fusion center to coordinate the participants during emergency scenarios

Additional considerations for network-based models	Value
Accessibility of input data (High, Medium, Low)	Low
Operational interdependency subtypes (P-physical, C-cyber, G-geospatial, L-logical)	P, C, G, L
Maturity (High, Medium, Low)	High
System states able to model	Yes or No
Original Stable State	Yes
Disruption (state transition)	Yes
Disrupted State	Yes
Recovery (state transition)	Yes
Recovered Stable State	Yes

2.2.2. Network-based models

Network-based models generally seek to describe a network or graph, \mathcal{G} , comprised of a set of nodes, \mathcal{N} , and a set of arcs, \mathcal{A} . The graphs may be either directed or undirected, but in most instances dealing with infrastructure systems, they are directed and represent the physical infrastructure systems. Occasionally some sort of mapping

function is employed to map arcs to pairs of nodes (Lewis 2009). In the case of interdependent infrastructure systems, this is usually modeled as a multilayered network (Bianconi 2018; Boccaletti et al. 2014; Kennedy 2003; Kivelä et al. 2014).

Bianconi (2018) describes various multilayered approaches to analyze complex networks including multi-plex, multi-slice, and network-of-networks. These variations deal with the mapping of network components between layers and whether they are mapped one-to-one in multi-plex and multi-slice structures or whether there is no one-to-one mapping. The use of a supernetworks and supraadjacency matrices are able to detail network-to-network connections. In general, interconnections and interdependencies are strictly bipartite between two different pairs of infrastructure systems (e.g., system *A* and system *B*). This leads many to model the interdependencies as a binary variable or parameter between a pair of infrastructure systems (González 2017; González et al. 2016; Lee et al. 2007; Sharkey et al. 2015).

Another element of modeling interdependent network flow models is the concept of multicommodity flow, where the infrastructure services are modeled as the commodities (Ahuja et al. 1993). This has led to several extensions of the multicommodity flow model to construct network flow models developed with the express purpose of modeling interdependent infrastructure networks during disruptions (Guha et al. 1999; Lee et al. 2009). A unique method proposed by Holden et al. (2013) used multi-function node operations to simulate the interdependencies among systems by allowing commodity conversion in a multicommodity network flow construct. This approach has some benefits in the ability to capture various aspects of commodity demand, flow through, conversion of one commodity to another, storage, and waste or

discharge. This approach flattens a multilayer network into one giant single layer network, which may have some disadvantages as well. Infrastructure data is often layered in data structures and are examined in the present work as multilayered systems.

Network models have not only been used to model interdependencies, but have been used for measuring resilience (Attoh-Okine 2016). Resilience-focused modeling has resulted in network measures that seek to quantify interdependence and resilience (Almoghathawi et al. 2017; Hosseini et al. 2016). This has led to work trying to quantify the cyber-physical-social interdependencies (Barker et al. 2017). An extension of Barker et al.'s (2017) work models community resilience and seeks for social equity in restoration resource distribution (Cutter 2016; Karakoc et al. 2020; Ramirez-Marquez 2019).

Other efforts have sought to model incremental network design, which in some sense is similar to recovery operations. Averbakh and Pereira (2012) helped establish some mathematical framework which was further employed in efforts to incrementally build or design a network (Baxter et al. 2014; Kalinowski et al. 2018). Some applications of this method are similar to restoration efforts.

Of particular interest is the application of network flow models in restoration of networks. Guha et al. (1999) looked at the recovery of power systems after disruptions. Ang (2006) likewise studied disrupted power systems and sought to find optimal recovery strategies. Nurre et al. (2012) developed an integrated network design and scheduling problem, which others have similarly built upon (Cavdaroglu et al. 2013; Iloglu and Albert 2018; Sharkey et al. 2015). Iloglu and Albert (2020) used a maximal covering problem construct in order to look at restoration activities.

While not an exhaustive review of network-based literature, the preceding summary establishes network-based flow models as a capable tool for addressing network restoration. The primary focus of this research is on network-based restoration activities within interdependent infrastructures. Therefore, the next subsection details several models considered as network-based IIR models.

2.2.3. Network-based interdependent infrastructure recovery models

This subsection details models that can be considered as network-based IIR models. This assessment is based on four inclusion criteria to include the models being network-based, recovery-focused, containing multilayered infrastructures, and exhibiting interdependency. Table 2.5 describes each of the inclusion criteria.

Table 2.5. Description of inclusion criteria that is used to classify models as network-based interdependent infrastructure recovery (IIR) models

Inclusion Criteria	Description
Network-based	Model or problem formulation must exhibit network flow, or flow of one or more commodities across a network of nodes and arcs (vertices and edges).
Recovery-focused	Model or problem formulation must include element of scheduling or repair to damaged components of the network(s).
Multilayered infrastructures	Model or problem formulation must include multiple infrastructure systems or layers that can be simultaneously evaluated.
Interdependency	Model or problem formulation must address interdependencies (i.e., operational, restoration) between the multiple layers within the overall system of systems.

Each network-based IIR model is discussed briefly using a modified interdependent infrastructure assessment framework proposed by Griot (2010). The most

meaningful modifications include detailing how interdependencies are handled and which interdependency subtypes are modeled. While only summaries of this assessment are captured in this chapter, Appendix B includes assessment notes on each model included in this research. The common assessment framework allows model comparison to highlight both unique and common features. Particular emphasis will be given to the formulations of Gonzalez's (2017) time-dependent interdependent network design problem (td-INDP) and Sharkey et al.'s (2015) interdependent integrated network design and scheduling (IINDS) problem. These two models provided the most comprehensive base in which to build the model presented later in this research.

Lee et al. (2007) developed the interdependent layer network (ILN) model. The objective of this model was to find the least cost recovery strategy by minimizing the cost of flow, the unmet weighted demand, and service disruption caused by interdependencies. This was achieved by creating a deterministic mixed-integer program (MIP). This model was built with the idea of modeling a similar event to the attack on and subsequent disaster that resulted from the collapse of the World Trade Center. The model considered power, telecommunications, and subway infrastructure systems on a dataset built with the help of infrastructure managers within New York City. Interdependent layers were connected by a dependency variable which created a binary relationship between the two infrastructure systems. This model proved to be able to generate optimal recovery strategies where all the damage and resources are known. Limitations of this model are that it required an "acceptable timeframe" for recovery operations, without specifically calling out what that was (Lee et al. 2007). This model could not support a scenario in which resources changed over time or if damage occurred at multiple points in time.

Variations or adaptations of this model also exist (Cavdaroglu et al. 2013; Loggins et al. 2019).

Building off of the work of Nurre et al. (2012), who presented the integrated network design and scheduling (INDS) problem, Cavdaroglu et al. (2013) built upon the work from the ILN and added elements of restoration task assignment and scheduling. The objective of this model also was to find least cost recovery strategies by seeking to minimize the cost of flow, unmet demand, unmet demand based on interdependencies, recovery costs of arcs, and assignment costs. The authors similarly employed a deterministic MIP, combined with some data pre-processing to try and shrink the instance size. They employed a specialized heuristic to find solutions rather than solving to optimality. This was largely due to the time index substantially increasing the number of constraints and computer limitations with memory management. Similar to Lee et al. (2007), the authors wanted to use a similar computing power to what would be expected from an emergency manager using a laptop. The scenario tested was some unspecified disruption to the power infrastructure and the effect on the telecommunications network. This model was effective in combining and fully integrating restoration planning and scheduling efforts for interdependent infrastructure systems. The formulation also provided a way to measure how well the services were being recovered throughout the process, rather than just at the end. Limitations with this model were assumptions that all workers had sufficient skills to accomplish any task no matter the network, one work group could accomplish any task, and no actual assignment costs were used based on an assumption of an organic workforce.

Sharkey et al. (2015) built upon the model proposed by Cavdaroglu et al. (2013) and Nurre et al. (2012) to develop the interdependent integrated network design and scheduling (IINDS) problem. The objective of this model was to more fully understand the timing of recovery by selecting nodes and arcs to restore, scheduling repairs by parallel work groups, and maximizing the cumulative performance of the network over a finite period of time. This work added several unique elements to include the concept of decentralized execution and the value of information sharing, integration of operational and restoration interdependencies, and perspectives on interdependent infrastructure datasets. The authors solved this problem by creating a deterministic MIP, solving it to optimality. Various heuristics were used to simulate the different information-sharing scenarios. Multiple binary interdependency variables were used to capture the various types of interdependencies. The authors critiqued one dataset, due to it being energy-lead, and therefore not completely telling of the ‘inter’-dependency between other systems. This led to the use of a different, customizable dataset. Advantages of this model include the ability to quantify the benefit of information sharing in a decentralized restoration construct and the integration of multiple restoration interdependencies. Limitations of this model include the assumption of instant and perfect information-sharing versus real-life estimations of recovery from different stakeholders and the absence of including various operational interdependencies.

Sharkey et al.’s (2015) objective function uses a node and time weight in order to ensure critical nodes are recovered. The objective is to maximize performance, which essentially measures the amount of demand met. Interdependency constraints are formulated to address the function of supply, demand, and transshipment nodes in the

interdependent (or child) infrastructure. Only two of five identified restoration interdependency subtypes were evaluated. The only operational interdependency subtypes used were physical and geospatial, with the geospatial being incorporated into the damage simulation.

Gonzalez (2017) developed what he called the time-dependent interdependent network design problem (td-INDP) model. This model served as a basis for subsequent work by the author to include the iterative INDP and stochastic INDP described later (González et al. 2016, 2017). The objective of td-INDP model seeks to find the least cost recovery strategies. This is achieved by first maximizing commodity flow through the use of surplus and deficit costs, which are being minimized. The objective function also seeks to minimize the costs associated with reconstruction activities, cost of flow, and by capturing cost savings in preparation for reconstruction efforts based on the geospatial repair interdependency subtype. This was achieved by developing a deterministic MIP, which was both solved to optimality and solved using various decomposition strategies. This model had a particular advantage of being capable of handling multiple operational interdependency subtypes, though only physical and geographical were used in the problem instance. This model used a one-to-any coupling strategy even though the authors suggested the model had the capability of incorporating other coupling strategies. The authors even presented some partial formulations of different coupling strategies. The problem modeled examined interdependencies between gas, water, and power networks after a simulated earthquake causing various levels of damage. The advantages of this model include the ability to handle multiple operational interdependency subtypes and coupling strategies. The limitations of this model include the lack of logical and

cyber interdependency subtypes, the lack of explicit formulation to handle various interdependency subtypes and coupling strategies within any given infrastructure system, and the assumption of complete and perfect knowledge at the time of disruption.

Gonzalez (2017) included surplus and deficit cost parameters, which essentially act as weights to ensure flow of commodities is restored as a first priority. This objective then seeks to maximize performance, which is measured as commodity demand met, by the use of penalty costs. This is a technique used by others as well who are seeking for least-cost recovery strategies (Cavdaroglu et al. 2013; Lee et al. 2007). A distinct difference in the scheduling constraints presented in the td-INDP is that they are not employed in the context of a scheduling problem. Rather, they are employed as a general restoration constraint. This generality means that it can encompass more than time required and team assignment, but also does not explicitly include those things. This generalization creates flexibility within the recovery model, but also lacks clarity and details that other models provide. This is done by virtue of an assumption that the work started in any given time will be completed in that time period. Therefore, the functionality of a node or arc is determined by whether or not it was selected for repair in one of the time periods under analysis.

Gonzalez et al. (2016) constructed the iterative INDP (iINDP), which removed the time index and instead used the time periods as iterations in the INDP. This heuristic solution to the td-INDP proved to change the computational burden from exponential to linear, significantly improving the flexibility to use for near real-time employment in disaster recovery. This heuristic also added a way to address previously fixed variables, by offering an iterative update to parameters. The authors noted this may provide a closer

approximation to the changing nature associated with recovery operations. Other model elements were very similar to the td-INDP and are not reported here. The advantages of this model were the significant reduction of computational time with an expanding time horizon and allowing the periodic update to parameters. Limitations include splitting the time horizon and use of a heuristic, which might not accurately depict the optimal solution. However, the heuristic did show convergence with the optimal solution. This model also had the distinct limitation of assuming non-realistic recovery times.

Gonzalez (2017) then incorporated uncertainty and developed the stochastic INDP (sINDP). This approach changed the strictly deterministic approach into one that included stochastic elements by utilizing stochastic embedded optimization. This was done over a number of discrete events using Monte Carlo simulation. This was constructed within a modified MIP, which included certain parameters that changed over the various events. The main advantage of this formulation was the addition of a set of scenarios which added uncertainty to parameters including the supply and demand of commodities, availability of resources, and the use of resources in recovery operations. This enabled a model user to adjust the levels of uncertainty. Disadvantages to this model remain the same as from the td-INDP, and although uncertainty is added, the model still assumes complete and perfect knowledge at the time of disruption and unrealistic recovery times.

Almoghathawi et al. (2019) developed a multi-objective restoration model. The multiple objectives of this model were to maximize the resilience, which was measured as a ratio of recovered performance versus performance without disruption, and finding the least-cost recovery strategy. Maximizing the resilience of the system was achieved by

using an ε -constraint method while minimizing the costs associated with the restoration process, commodity flow, disruption, and unmet demand. This was done by developing a deterministic MIP of discrete events over certain ranges. They analyzed power and water systems by using a fictional dataset generated using algorithms. The primary advantage of this model was the formulation and inclusion of a resilience measure in the objective function that allowed the future exploration of the balance between “withstanding a disruption” and “recovering from a disruption,” which represent the two primary dimensions of resilience (Almoghathawi et al. 2019). Limitations of this model consist of only one crew being assigned to a task with no allowance for multiple crews to be assigned, no partial disruption or degraded conditions, only looking at physical interdependency, and using a fictitious dataset.

From this review of network-based IIR models it is clear that significant progress has been made toward the integration of network design (selection of nodes and arcs to repair) and scheduling (assigning work crews) for the purpose of restoring interdependent infrastructure systems. More work needs to be accomplished and several aspects or characterizations of recovery operations were found during this analysis and are explained in the following section.

2.3. Characterization of Recovery Operations

Based on the literature and models evaluated three primary objectives were discovered which form a recovery operations trilemma. Additionally, several assumptions repeatedly characterized recovery operations and have implications in the modeling and simulation of IIR. The first subsection discusses the recovery operations trilemma and the second subsection discusses the characterizing assumptions.

2.3.1. The recovery operations trilemma

Three primary objectives were discovered to include minimizing the cost of recovery, minimizing the time of recovery, and minimizing the loss of operability. Each of these objectives are briefly discussed and then are combined in the recovery operations trilemma.

Finding least cost recovery strategies was the most prevalent objective. Gonzalez et al. (2016) included specific fixed recovery costs for every node or arc that was damaged and selected for repair. The sINDP formulation included uncertainty and variability of recovery costs (González 2017). Most authors used fixed costs, though this is unlikely the case in true disaster recovery when scarce resources may drive recovery costs up (González et al. 2016; Sharkey et al. 2016).

Finding the quickest way to recover infrastructure systems was also a prevalent objective. What was not as common was realistic times associated with tasks. Gonzalez et al. (2016) used an assumption that a certain number of work tasks could be accomplished within a given time period. They varied the number of work tasks that could be accomplished within a given time period from 3 to 12, disregarding the notion that some activities take longer than others. Only one set of authors included a notion that some tasks under certain conditions make take longer than necessary (Sharkey et al. 2015).

Finding a recovery solution that minimized loss of operability or maximized system performance was a common objective. One way to think about this objective is by discussing the type of repair performed. Type of repair refers to two different ideas found in the literature, namely 1) a notion of expedient or temporary repair versus full repair

and 2) partial repair leading to partial operability. Lee et al. (2007) made a clear distinction that the temporary repairs were representative of quick fixes and not full repairs. Full repair of damaged facilities in terms of cost and time can be significantly higher than the immediate burden of expedient repair which restores some level of operability. Partial work was not permitted in any models prior to a work crew being assigned to a new restoration task; every model assumed a non-preemptive environment (Pinedo 2016). Some models took into account completion of certain restoration tasks spanning multiple time periods (Cavdaroglu et al. 2013; Nurre et al. 2012; Sharkey et al. 2015). A common surrogate of operability or performance was meeting demand.

These three objectives are actually competing objectives and form a recovery operations trilemma. One definition of trilemma is a difficult decision between three options, where the person deciding can only pick two (“Trilemma” 2021a; “Trilemma” 2021b). This decision tradespace parallels the construction/project management trilemma of cost, speed, and quality (Atkinson 1999) or the infrastructure asset management trilemma of cost, performance, and risk (International Organization for Standardization (ISO) 2014). The basic idea in terms of optimality is a Utopian point in one of these three objectives will not result in a similar Utopian point in the other two, leading to the need for a compromise solution or Pareto optimal solution (Arora 2017).

Table 2.6 summarizes which objective functions the above-mentioned IIR models used. From this brief analysis 5 included cost, 3 included time, and 3 included some form of operability.

Table 2.6. Matrix of IIR models compared to cost, time, and operability objectives

General Objective Description	Lee et al. (2007)	Cavdaroglu et al. (2013)	Sharkey et al. (2015)	González et al. (2016)	González (2017) ^c	Almoghathawi et al. (2019)
Minimizing cost	X	X	-	X	X	X
Minimizing repair time	X ^a	-	X	-	X ^a	-
Minimizing operability loss	X	- ^b	X	- ^b	- ^b	X

^a Implicit inclusion by use of time dependent index; ^b pseudo inclusion by using penalty costs based on unmet demand; ^c includes td-INDP and sINDP models

2.3.2. Characterizing assumptions

Several assumptions characterized how recovery operations were modeled and have implications in the resulting recovery strategies. These assumptions include teaming structures, sufficient resources, negligible transit time, work efficiency, no degraded conditions, no external support, compressed phases of recovery, and success of recovery. This subsection explains each of these characterizing assumptions followed by an assessment of which models addressed any of these assumptions.

Teaming structures used in recovery operations have typically employed parallel teams capable of handling any restoration task necessary (Cavdaroglu et al. 2013; Nurre et al. 2012). This means that regardless of the infrastructure system, it is assumed that the right personnel are in every team to handle any task on any network. A closer representation of reality is teams, whether equal in manpower or not, are designated for a given infrastructure system (Almoghathawi et al. 2019; Sharkey et al. 2015). This equates

to specific skill sets working on compatible infrastructure systems (e.g., electricians doing work on the electrical power infrastructure and plumbers working on water infrastructure). A different approach allows for flexible teaming structure, tailored to meet the restoration task. This requires more granularity of requirements from the restoration activities, which would likely be available after initial assessments are completed.

Sufficient resources noted from the IIR models were mainly temporal or monetary while all other resources were assumed to be sufficient. The resources of recovery time and cost are appropriate and important. These two resources were addressed by the objectives of the various models. However, the assumption and reliance on adequate resources always being available may be inappropriate. The work by Gonzalez et al. (2017; 2016) had an unspecified resource association in the model formulation. The text suggested it was a general formulation that could account for any number of resources required for the restoration activity. Although, this inclusion was unique, no resource management or accounting was noted except that the constraints required what was used for recovery had to be less than what was available. It is suggested that low-quantity and high-demand material, vehicles, and equipment should be considered in IIR models incorporating resource requirements.

Negligible transit time is a self-explanatory assumption and was not addressed by any of the IIR models. Rather, it was mentioned by Aksu and Ozdamar (2014) and Yan and Shih (2009). A concept of administrative delay could be added to account for transit time between recovery task locations. It is also possible that certain equipment assets travel at much lower speeds, making this perhaps more impactful and something to

quantify if the assumption of sufficient resource availability is removed. Depending on the length of time periods or the length of restoration tasks, this may or may not be negligible (Aksu and Ozdamar 2014).

Work efficiency assumes that the rate of repair remains constant despite certain conditions that could prolong an activity. The following could affect the efficiency of a work crew, all of which are typically assumed away: skill level or proficiency, skill matching, degraded work conditions (i.e., hazardous work conditions, contamination, chemical spills, and confined spaces), and other procedures that require work stoppage (i.e., military alarm response during attacks and shelter in place protocol). Sharkey et al. (2015) are the only set of authors to include any concept of work efficiency based on slower efficiency due to another task not being accomplished. As noted previously, some authors did assume there was skill matching by assigning work crews within a given infrastructure system, while others did not even mention whether or not this mattered.

No degraded conditions assumes that no adverse work conditions exist which decrease work efficiency or could cause work to stop. Sharkey et al. (2015) somewhat challenged the no degraded conditions assumption, which he referred to as effectiveness precedence. The only other set of authors that addressed degraded conditions was Holden et al. (2013). Holden et al. were the only authors that allowed for operations to continue in a degraded condition. No specifics were given, but by allowing for partial functionality, they were able to show how long a disaster scenario could be endured before encountering a breaking point of a predetermined level of service. An additional consideration of interest to the military could be activities associated with operating in a chemical, biological, radiological, or nuclear environment.

No external support assumes that all resources, personnel, and material are on hand and within the management of the modeled organization(s) (Cavdaroglu et al. 2013). Most authors did not address whether or not this happened except for Cavdaroglu et al. (2013) which specifically stated that all crews were part of the management team's inherent resources and therefore all assignment costs were zero, simplifying the model. However, as pointed out by Lee et al. (2007), recovery operations are collaborative and often require resources from outside an organization. This is the role of the Emergency Operations Center, if one exists, in the disaster response and recovery.

Compressed phases of recovery assume complete and total knowledge at the time of disruption disregarding the normal flow of information and stages of disaster recovery. Gonzalez et al. (2016) and Sharkey et al. (2015) allude to the various stages of recovery but still assumed complete and total knowledge. In the case of a disaster, there are often many uncertainties and information accumulates piecemeal. This is reflected as the sloped decline on the resiliency curve by Henry and Ramirez-Marquez (2012) in contrast to other models, which show an abrupt drop (Attoh-Okine 2016). While the failure might indeed be abrupt, often the damage information is not instantaneous; however, sensor integration may change this in the future (Sotres et al. 2017). This assumption was only partially addressed by Sharkey et al. (2015) when addressing the traditional precedence and including information sharing analysis.

Success of recovery is an assumption that takes out the uncertainty of reality by assuming every repair effort is successful. González (2017) was the only author that added any element of uncertainty, though he did not specifically address the success of repair efforts. Therefore, no IIR models addressed this assumption and all models

assumed that following recovery the node or arc restored is fully functional. This may very well be a valid assumption, but it does not always reflect reality. It is highlighted as a characterizing assumption since it was mentioned and may or may not be valid (Cavdaroglu et al. 2013; Sharkey et al. 2015).

Table 2.7 shows which IIR models challenged, in some respect, the prevailing assumptions. From this analysis all the characterizing assumptions had three or fewer models challenging the prevailing assumptions to some level. No models challenged all the assumptions. Three characterizing assumptions were not challenged by any IIR models, specifically negligible transit time, no external support, and success of recovery. Each one of these prevalent assumptions represent areas of potential research.

Table 2.7. Indication of which IIR models challenged characterizing assumptions

Characterizing Assumption	Lee et al. (2007)	Cavdaroglu et al. (2013)	Sharkey et al. (2015)	González et al. (2016)	González (2017) ^a	Almoghathawi et al. (2019)
Teaming structures	-	X	X	-	-	X
Sufficient resources	-	-	-	X	X	-
Negligible transit time	-	-	-	-	-	-
Work efficiency	-	-	X	-	-	-
No degraded conditions	-	-	X	-	-	-
No external support	-	-	-	-	-	-
Compressed phases of recovery	-	-	X	-	-	-
Success of recovery	-	-	-	-	-	-

^a Includes td-INDP and sINDP models

2.4. Interdependent Infrastructure Model Data and Validation

A revealing result of the foregoing analysis was the complication over data involving interdependencies and their subsequent availability. This was also complicated by no clear method of validation established for these models. These two problems will be briefly described based on their importance to the current research.

2.4.1. Data availability

Mentioned by several authors is the lack of data on interdependencies, mostly due to data availability (Almoghathawi et al. 2017, 2019; Buldyrev et al. 2010; Ouyang 2014). This led some to the creation of unique datasets (González et al. 2016; Lee et al. 2007; Sharkey et al. 2015). Others used fictitious datasets that were either theoretical (Holden et al. 2013) or generated (Almoghathawi et al. 2019).

Sharkey et al. (2015) described this problem at some length and criticized a dataset that had been used previously as being biased in terms of identified interdependencies (Cavdaroglu et al. 2013; Lee et al. 2007). This led the authors to seek another customizable dataset that was representative of a real system, but could provide the necessary peculiarities for their modeling effort (Loggins et al. 2013).

Several issues surrounding data availability have been identified, but limited solutions exist. One of the main issues is the sensitive nature of certain infrastructure data (Lee et al. 2007). This is complicated by the complex management of various infrastructure systems and some infrastructure system data being able to lead to competitive advantage by some users (Rinaldi et al. 2001). Some data that is available is at the wrong level of granularity and forces models to analyze interdependencies at a higher abstraction (Barr et al. 2016; White et al. 2016; Zhang et al. 2018). Some data-

sharing initiatives have been employed at the national level with limited success (Department of Homeland Security 2013; Peretti 2014). There is a need for data to perform meaningful analysis and to truly understand the implications of interdependencies in operation and restoration activities (Eusgeld and Kröger 2008; Ouyang 2014). This remains a challenging area of all interdependent infrastructure modeling and simulation efforts.

2.4.2. Model validation

Ouyang's (2014) review of various modeling and simulation efforts for interdependent infrastructure resilience highlighted two ways in which validation is typically undertaken. The first method of validation is to compare model outputs to previous models and historical data. The second method of validation is to use empirical methods on historical events to develop key metrics or indicators used for validation. Both of these methods are useful, but may be insufficient. Systems are changing and the interconnections from historic events are not necessarily the ones that will be relevant in the future. Historical data may have a problem reflecting the evolutionary change in the complex adaptive systems that constitute interdependent infrastructure systems (Ouyang 2014; Rinaldi et al. 2001). Use of empirical methods to develop metrics still has challenges to determine how best to use these metrics in decision-making and in response and restoration activities (Ouyang 2014).

Current validation strategies seen in the literature involve 1) comparison with other models, 2) heuristics versus a mathematical model, and 3) a human-in-the-loop structure. This last method was employed by Lee et al. (2007) and Gonzalez et al. (2016). Improvements in model validation may be hard to make, since even a model that suggests

optimal recovery strategies is only optimal based on the assumptions and biases programmed into it. However, some effort of scaled real-world simulation may be profitable, and implementation by the Department of Defense “pull-the-plug” exercises might be a way to validate some aspects of models in the future (United States Department of Defense 2019).

2.5. Summary of Literature Review

From this literature review, certain areas have little to no documented research. These areas include integrating all known interdependency subtypes and coupling strategies in a simultaneous manner and challenging common assumptions. The following list compiles areas where further research is desired, though not all will be addressed in the present work.

- No IIR model-to-date has included, inherent in the formulation, the four operational interdependency and six restoration interdependency subtypes.
- No IIR model-to-date has included, inherent in the formulation, the four coupling strategies.
- No IIR model-to-date has included a preemptive environment.
- All IIR models use strict binary operability variables and do not allow for partial operability.
- There are only a few interdependent network model datasets and none exist which are defense- or military-focused
- IIR models have only challenged some of the prevalent characterizing assumptions which have the potential to impact recovery solutions and objectives.

III. The Customizable Artificial Community (CLARC) Database¹

3.1. Introduction

The Customizable Artificial Community (CLARC) Database represents a region-sized database for modeling and simulation of interdependent infrastructure systems (Little et al. 2020). This database has been used by multiple authors mainly exploring recovery of interdependent infrastructure systems following a disruption (Loggins et al. 2019; Loggins and Wallace 2015; Sharkey et al. 2015). The CLARC Database consists of 1,305 nodes representing 47 different nodal asset types across ten infrastructures and 4,764 arcs representing 21 different linear asset types across five infrastructures. This database also has 2,631 interdependent relationships between infrastructures, where infrastructure A depends on infrastructure B. These interdependent relationships are defined by the database creators to exist when a node in infrastructure A has a demand in infrastructure B. This definition also assumes the demand in infrastructure B is required for the operation of the node in infrastructure A. These relationships are representative of node-to-node interdependencies mostly of a physical or cyber nature (Rinaldi et al. 2001).

These technical notes summarize data inconsistencies found within the CLARC Database, identifies two underlying concerns, and presents suggested improvements.

¹ The contents of this chapter were independently submitted for publication by Moore and Jacques to ASCE's *Journal of Infrastructure Systems* on 10 June, 2021. The submitted article was titled "Technical Notes on Using and Improving the CLARC Database for Interdependent Infrastructure Modeling and Simulation." Additional notes and explanations are found in Appendix A of this dissertation.

3.2. Corrections to Use the CLARC Database

Data irregularities were identified and corrected addressing minor issues within the *Clarc_County_Social_Ver4.accdb* as found in Sharkey et al. (2018). These issues included missing demand, erroneous demand, mislabeling, missing location information, and other arc inconsistencies. Each one of these types of issues are explained briefly in Table 3.1.

Table 3.1. Explanation of data inconsistencies found in CLARC Database

Type	Issue	Explanation
1	Missing Demand	When an asset had zero demand for a certain commodity while other like assets had a non-zero demand. Missing demand was discovered by filtering by data fields <i>Definition</i> and <i>Name</i> and comparing the demand across like assets.
2	Erroneous Demand	When an asset had demand for a certain commodity that didn't make logical sense. Erroneous data was detected when examining stated interdependencies between systems.
3	Mislabeling	Mismatch of naming convention which can cause confusion. Found through line-item evaluation by examining other parameters such as capacity or demand.
4	Missing Locations	Data field <i>Census_Tract</i> was empty on certain assets. This field was used to simulate damage when using HAZUS-MH in multiple papers ^a .
5	Other	Self-explanatory. Several of the issues are duplications of arcs.

^a See Loggins and Wallace (2015) and Sharkey et al. (2015) for examples

There were 322 data errors discovered across five different types of issues. Table 3.2 summarizes correction type, quantity, infrastructure layer, and identifies the asset *Name* or *Definition* when appropriate. The data field *Name* is used with a numerical indicator following the root name (e.g., *Wastewater_Treatment_Plant_7*). The data field *Definition* represents the asset type and is used for brevity when appropriate. The

transportation and emergency response infrastructure layer is abbreviated as TER in the CLARC Database and in these notes.

Table 3.2. Summary of 322 data errors found in CLARC Database

Type	Qty	Infrastructure	Asset Definition or Name	Notes (if applicable)
1	1	Wastewater	Wastewater_Treatment_Plant_7	
1	5	Wastewater	Pump_Station_61 & 208 to 211	
2	34	Water	ATM_1 to 34	ATMs do not require water
2	34	Wastewater	ATM_1 to 34	ATMs do not produce wastewater
3	30	Power	<i>Def.:</i> CF_Dist_Line, <i>Name(root):</i> Power_Traffic_Line	<i>Def.</i> changed to Power_Traffic_Line
3	2	Water	Waste_to_CF_269 & 270	Changed to Water_to_CF_354 & 355
3	10	TER	<i>Def.:</i> Local, <i>Name(root):</i> Trans_CF_Conn	<i>Def.</i> changed to Trans_CF_Conn
3	11	Wastewater	Waste_Main_Pipe_367 to 377	Not labeled as bi-directional pairs; Renamed as Waste_Main_Pipe_366 to 371
3	2	Wastewater	Waste_Main_Pipe_223	Arc is supposed to be bi-directional arc between nodes 9508 and 9319 rather than duplicate loop on node 9508
4	4	TER	Power_Traffic_Line	
4	1	Wastewater	Waste_Main_Pipe	
4	55	TER	Trans_CF_Conn	
4	64	Wastewater	Waste_to_CF	
4	64	Water	Water_to_CF	
5	1	Wastewater	Waste_Main_Pipe_380	Duplicate arc based on change to Waste_Main_Pipe 223
5	2	TER	Trans_CF_Conn_403 & 415 and Trans_CF_Conn_405 & 416	Duplicate arcs, Trans_CF_Conn_415 & 416 were deleted
5	2	Communications	Signal_83 & 152	Reciprocal arcs missing; not added

In summary, these errors were mostly minor, but serve as an improvement upon the original dataset. In addition to these errors, some underlying concerns arose and are explained in the following subsection.

3.3. Concerns and Suggested Improvements in Using CLARC Database in Modeling and Simulation

Two underlying concerns with the original data became apparent when using the CLARC Database for modeling. The first concern was the lack of telecommunication infrastructure connectivity. Of the 45 non-telecommunication node types, only four had a communication demand, namely: ATM, Gas_Station, Emergency_Communication_Center, and Census_Point. The remaining 41 nodal asset types that had no communication demand; however, 34 of the remaining 41 were identified as having day-to-day and emergency telecommunication requirements. Table 3.3 lists all 34 assets and examples of possible telecommunication requirements.

The second concern was the lack of people or workers as a commodity within the TER infrastructure layer. The TER commodities within the system are EMS, Police, and Fire. While these listed commodities are critical emergency response commodities that use the roadways, they also must compete with essential workers, repair crews, and the general populace. During response and recovery phases of an emergency, the general populace provides the work crews to sustain response and recovery efforts. Additionally, large portions of the populace may or may not be simultaneously trying to evacuate an area due to a natural hazard event thus creating congestion and infrastructure capacity competition. This competition is not part of the model due to the absence of supply and demand of people as a commodity throughout the network. Table 3.4 lists the

modifications and additions within the demand portions of the nodes to address these additional communications and personnel demands. These suggested modifications must also be accompanied by viable delivery pathways (i.e., new arcs) as necessary. These concerns and suggested improvements enhance the reality of modeling efforts using the CLARC Database.

Table 3.3. 34 nodal assets have day-to-day and emergency telecommunication requirements not captured in the original dataset

Node Asset Types	Information & Telecommunication Requirements
Airport	Air Traffic Control, radar, telephone, internet
Banking_Central_Office	ATMs, bank transactions, telephone, internet
Bus_Terminal	WIFI, telephone, internet
Central_Office	Telephone, internet
Child_Residential_Facility	Telephone, internet
College	WIFI, telephone, internet
EMS_Station	911 calls, dispatch, telephone, internet
Ferry	Telephone
Fire_Station	911 calls, dispatch, telephone, internet
Fuel_Terminal	SCADA ^a , telephone
Group_Home	Telephone, internet
Hospital	WIFI, dispatch, telephone, internet
Hotel	WIFI, telephone, internet
Industry ^b	SCADA, telephone, internet
Jail	Telephone, internet
Nursing_Home	Telephone, internet
Police_Station	911 calls, dispatch, telephone, internet
Pump_Station	SCADA
School ^c	Telephone, internet
Shelter	Telephone
Substation ^d	SCADA
Wastewater_Treatment_Plant	SCADA, telephone
Water_Treatment_Plant	SCADA, telephone
Well_Site	SCADA

^a SCADA – supervisory control and data acquisition; ^b Represents 8 different industry types; ^c Represents 3 different school types; ^d Represents distribution and transmission types

Table 3.4. Suggested *Communication* and *People* demand data by node type

Infrastr.	Asset	"Communication"		"People"
		Orig.	New	New
PWR	Dist_Substation		1	
	Steam_Plant		10	10
	Trans_Substation		1	
WTR	Water_Treatment_Plant		5	5
	Well_Site		1	
WWT	Pump_Station		1	
	Wastewater_Treatment_Plant		5	5
TER	EMS_Station		10	10
	Fire_Station		24	25
	Police_Station		24	25
	Banking_ATM	1	1	
	Banking_Central_Office		10	10
	Fuel_Gas_Stations	1	5	5
	Fuel_Fuel_Terminals		5	5
	Hospital		95	100
Travel	Airport		475	500
	Bus_Terminal		5	5
	Ferry		5	5
	Hotel		10	10
Education	Jail		24	25
	School_High_School		48	50
	School_Middle_School		48	50
	School_Elementary_School		24	25
	College		475	500
Healthcare	Child_Residential_Facility		24	25
	Group_Home		24	25
	Shelter		5	5
	Nursing_Home		48	50
Industry	Emergency_Communication_Center	1	24	25
	Industry_Chemical_Plant		475	500
	Industry_Solar_Plant		475	500
	Industry_Battery_Plant		238	250
	Industry_Xray_Plant		238	250
	Industry_Distribution_Center		95	100
	Industry_Software_Company		48	50
	Industry_Steel_Company		95	100
	Industry_Lumber_Yard		24	25
Residential	Census_Point	1	500	

3.4. Conclusions

The CLARC Database is a well-matched dataset for interdependent infrastructure modeling and simulation. The 322 listed corrections to the original database should serve to profit any future use of the dataset.

Two large concerns were apparent due to telecommunication connectivity and the absence of people as a commodity within the standard dataset. These concerns are able to be overcome with the information and suggestions expressed to include the connectivity needed and the assets that require personnel for delivery of infrastructure services.

IV. The Lite Base Interdependent Infrastructure Recovery Model (LiteBIIRM)¹

4.1. Introduction

Changes in infrastructure management and protection are evident in current trends with Industry 4.0, Smart Cities, and City of the Future initiatives (American Society of Civil Engineers 2019; Rutgers and Sniderman 2018). Collectively these changes require massive quantities of data which can be hard to acquire or access. While certain strategies have been employed to overcome data access challenges, it remains a significant problem.

The work presented herein addresses current work that proves useful when encountering access issues for modeling and simulation of interdependent infrastructure systems. It explores two of the six dimensions of interdependent infrastructure systems called interdependency type and coupling (Rinaldi et al. 2001). This paper then leverages these concepts of interdependency type and coupling as a way to overcome incomplete data. This is accomplished by modifying a commonly used interdependency parameter to incorporate these two elements, which allows for complex interdependencies to be created based on the available infrastructure data. This work's applicability is shown by comparing the results of recovery following a disaster for a network with all required infrastructure data and a network with a significant portion of the data missing.

¹ The contents of this chapter were independently submitted and accepted for publication by Moore, Jacques, and Schuldt to INFORM's *Winter Simulation Conference 2021* on 9 April, 2021. The submitted conference paper was titled "Leveraging Network Interdependencies to Overcome Inaccessible Civil Infrastructure Data."

4.2. Literature Review

This section details relevant literature for two topics important to this research. The first topic concerns current methods to overcome incomplete data for infrastructure modeling and simulation (M&S). The second topic is handling operational interdependencies by the use of an interdependency parameter in network-based mathematical programs. This work combines these two topics by showing how interdependency parameters and coupling strategies can help overcome partial or incomplete infrastructure data.

4.2.1. Overcoming inaccessible infrastructure data for M&S

Issues with access to infrastructure data typically stem from one of three reasons: the data is sensitive, proprietary, or lacks sufficient quality (Ouyang 2014). Sensitive infrastructure information is the type of information that could cause security concerns for a community if mishandled or inappropriately used. Geospatial coordinates of water storage access points are an example of this. Proprietary infrastructure information is the type of information that allows a private company providing an infrastructure service (e.g., drinking water, electricity, etc.) some business advantage for sole ownership and control of the information. Proprietary information is also not specifically mandated for public disclosure. Data quality concerns may stem from sparse or randomly collected data, lack of standardization in data collection, and subjective data. This last issue is deeply concerning, seeing how emerging technology uses data to inform so many decisions, and data quality is not always readily apparent.

The Cybersecurity and Infrastructure Security Agency (CISA) of the United States Government has taken steps towards securing a data repository, and they have

incentivized critical infrastructure information (CII) sharing through the Protected CII (PCII) Program (CISA 2005). The PCII was initiated in 2002, with the passing of the CII Act, and updated in 2006 when additional regulations were added to ensure proper handling and use of CII (CISA). However, industries and communities are still reluctant to exchange data and/or relinquish proprietary data (Peretti 2014).

These governmental efforts are commendable; however, the data is also not widely available for use or research. Therefore, researchers and practitioners in the area of infrastructure M&S have come up with different ways to overcome the access to data issues. Ouyang (2014), in a review article on M&S for critical interdependent infrastructure, identified three workarounds: 1) empirical data harvesting from historical events, 2) random or characteristic-specific generated networks, and 3) representative data that seeks to take real systems and remove sensitive or proprietary information. While none of these are ideal, they have made substantial research and improvements possible. The present work uses the third option by using a representative dataset.

4.2.2. Operational interdependency parameter in network-based programming

Rinaldi et al. (2001) identified six dimensions of infrastructure interdependent relationships; however, only two are critical for the present work. These two are interdependency type and coupling. In their study, they provided a useful classification of the types of interdependencies that affect network operations. These are physical (i.e., dependency based on the flow of materials), cyber (i.e., dependency based on the flow of information), geospatial (i.e., dependency based on proximity), and logical (i.e., any other dependency). These authors also described the coupling as being either tight or loose and either linear or complex. Tight coupling suggests a strict interdependency between

systems (e.g., an electrically driven water pump). A loose coupling suggests there is an effect of one system on another, but it may not be directly felt (e.g., mining operation disruption may slow road repair and maintenance, but not immediately due to the buffer of raw material). Linear relationships behave proportionally, while complex relationships are not proportionally related or the proportions change over time.

González et al. (2016) introduced an idea of how to view these two dimensions in their presentation of the interdependent network design problem (INDP). While the authors only presented one coupling strategy, they described four variations that can cover most situations. These four strategies can be described as one-to-one, one-to-any, one-to-all, and one-to-many couplings. The authors suggested that multiple interdependency types and coupling strategies could be implemented if necessary; however, the method for employing multiple types and coupling strategies was to make independent sets of constraints with new variables and new interdependency parameters related to different types and coupling strategies. The four different coupling strategies will be discussed in more depth in the following section.

Other authors modeling interdependent infrastructure recovery have also used an interdependency parameter to describe whether infrastructure systems are interdependent. Lee et al. (2007) used a series of connector parameters which allowed them to establish node-to-node and node-to-arc relationships, both types being a one-to-one style of coupling. This formulation was a build-as-you-go type of formulation depending on what relationships were needed, and it also used special sets extensively. Cavdaroglu et al. (2013) used a binary variable equal to 1 if the slack of unmet demand at the parent node was zero, allowing the child node to be operable. This parameter did not include various

interdependency types or couplings, thereby reflecting only a one-to-one relationship. Sharkey et al. (2015) used a binary variable similar to Cavdaroglu et al., except that their binary variable was arc-to-arc instead of node-to-node and didn't require all demand to be met, but rather a sufficient amount of demand. This, in essence, allowed for some degradation of service before the interdependency rendered the child node inoperable. This also represents a one-to-one relationship. In contrast to these methods, Almoghathawi et al. (2019) and Karakoc et al. (2019) used an operability variable instead of an interdependency parameter to relate physically interdependent infrastructure systems. These examples also represent a one-to-one and node-to-node relationship.

There is currently no model that employs both interdependency types and coupling strategies as an inherent part of the interdependency parameters or constraints. This paper proposes a way to implement such an integration. This modified interdependency parameter is then used to show how it can help overcome situations with partial infrastructure data.

4.3. Methodology

This section pulls together the formalization of coupling strategies and integrates those strategies in a combined network design and scheduling problem. First, the general notation used in the mixed-integer program (MIP) is given. Second, coupling strategies are explained in detail, given a mathematical expression, and provided with anecdotal context. Third, the MIP integrates the coupling strategies and interdependency types into the formulation to address the combined network design and scheduling problem.

4.3.1. General notation for MIP

The combined network design and scheduling problem is based on a graph, $\mathcal{G}(\mathcal{N}, \mathcal{A})$, comprised of nodes and arcs divided into layers indexed by $k \in \mathcal{K}$. Each infrastructure layer has one or more commodities indexed by $l \in \mathcal{L}^k$. The network is assumed to be damaged, which means that subsets of nodes and arcs within each layer have become inoperable. These nodes and arcs must be repaired by assigning work crews and repairing the nodes and arcs. Table 4.1 summarizes the relevant notation for the MIP.

Table 4.1. General notation for the MIP comprising sets, variables, costs, and other parameters for flow and scheduling

Sets	Description	Variables	Description
\mathcal{K}	The set of infrastructure layers.	x_{ijlt}^k	The variable of flow of l in arc.
\mathcal{N}	The set of nodes, indexed as i .	α_{ijwt}^k or α_{iwt}^k	Binary variable equal to 1 if work crew w assigned to repair arc or node.
\mathcal{N}^k	The subset of nodes.*		
\mathcal{N}'^k	The subset of damaged nodes.*	β_{ijwt}^k or β_{iwt}^k	Binary variable equal to 1 if arc or node was repaired by work crew w .
\mathcal{A}	The set of arcs, indexed (i, j) .		
\mathcal{A}^k	The subset of arcs.*		
\mathcal{A}'^k	The subset of damaged arcs*.	y_{ijt}^k or y_{it}^k	The variable between 0 and 1 of operability of node or arc.
\mathcal{L}^k	The set of commodities.*		
\mathcal{W}^k	The set of work crews.*	x_{ilt}^{-k}	The variable of unmet demand of l at node.
Ψ	The set of interdependency types, indexed as ψ .	$x_{ilt}^{+,k}$	The variable of surplus of l at node.
Ξ	The set of coupling strategies, indexed as ξ .		
\mathcal{T}	The set of T time periods evaluated, indexed as t .	<u>Parameters</u>	
<u>Costs</u>		b_{ilt}^k	The amount of supply or demand of l .
c_{ijlt}^k	The cost of flow of l in arc.	u_{ijt}^k	The capacity of arc for all commodities.
a_{wt}^k	The cost rate of assigning w .	p_{ij}^k or p_i^k	The processing time for repair of arc or node.
q_{ijt}^k or q_{it}^k	The cost of repairing arc or node.	μ_A or μ_B	Priority weight between 0 and 1 for objectives A and B .
μ_{ijt}^k or μ_{it}^k	The value (cost equivalent priority) of arc or node.		

* Superscript k means in infrastructure layer $k \in \mathcal{K}$; subscript t means at time period $t \in \mathcal{T}$. Asterisk is used only for sets but pertains to variables and parameters as well.

An additional parameter and set dealing with the integration of the coupling strategies and the interdependency types are detailed in the following subsection.

4.3.2. Operational interdependency parameter and coupling strategies

Let $\gamma_{i\tilde{i}\psi\xi}^{k\tilde{k}}$ be a parameter that takes on a value from 0 to 1, describing a parent-child relationship between parent node $i \in \mathcal{N}^k$ and child node $\tilde{i} \in \mathcal{N}^{\tilde{k}}$ based on some interdependency type $\psi \in \Psi$ and coupling strategy $\xi \in \Xi$. This operational interdependency parameter effectively integrates the elements of previous work, which allows for a node-to-node pairing. This parameter expands upon previous work by adding characterization of interdependency type and coupling. This means that a node can have more than one type of interdependency relationship between node pairs. This also expands the interdependency relationship of a child node to one or more parent nodes.

Before describing the coupling strategies in depth and describing how they affect the interdependency parameter, it is worthwhile to define the sets Ψ and Ξ . The set $\Psi = \{physical, cyber, logical, geospatial\}$, which encompasses the operational interdependency types identified by Rinaldi et al. (2001). The set $\Xi = \{one2one, one2any, one2all, one2many\}$, where each of these relationships is explained below. An additional subset, used as a filtering set, is advantageous in the programming of the MIP. Let $\mathcal{N}_{i\psi\xi}^{k\tilde{k}}$ be a subset of nodes in a given network $k \in \mathcal{K}$, that have an operational interdependent relationship of some type ψ with another node $\tilde{i} \in \mathcal{N}^{\tilde{k}}$ in a different network $\tilde{k} \in \mathcal{K}$ based on some coupling ξ , where $\mathcal{N}_{i\psi\xi}^{k\tilde{k}} \subseteq \mathcal{N}$.

The one2one coupling describes when a child node $\tilde{i} \in \mathcal{N}^{\tilde{k}}$ can be functional only if a parent node $i \in \mathcal{N}^k$ is functional. This effectively means that when $\xi = one2one$,

$\mathcal{N}_{i\psi\xi}^{k\bar{k}}$ is a singleton set for a given interdependency type ψ (Figure 4.1). The one2any coupling is the case when at least one of any number of nodes $i \in \mathcal{N}_{i\psi\xi}^{k\bar{k}}$ must be functional for the child node $\tilde{i} \in \mathcal{N}^{\bar{k}}$ to be functional (Figure 4.2). The one2all coupling is where all nodes $i \in \mathcal{N}_{i\psi\xi}^{k\bar{k}}$ must be functional for the child node $\tilde{i} \in \mathcal{N}^{\bar{k}}$ to be functional. This means that each one2all parent-child relationship receives an equal portion of the interdependency parameter, where the sum of all parts equals one (Figure 4.3). Finally, one2many coupling means that a portion (not necessarily equal) of the interdependency parameter is associated with each parent-child relationship, where the sum of all parts equals one (Figure 4.4). Therefore, let $\omega_{i\psi t}^{k\bar{k}}$ be the portion of functionality or weight between nodes $i \in \mathcal{N}_{i\psi\xi}^{k\bar{k}}$ and $\tilde{i} \in \mathcal{N}^{\bar{k}}$, where $\sum_{i \in \mathcal{N}_{i\psi\xi}^{k\bar{k}}} \omega_{i\psi t}^{k\bar{k}} = |\mathcal{N}_{i\psi\xi}^{k\bar{k}}|$, $\forall \psi \in \Psi, t \in \mathcal{T}$ when $\xi = one2many$.

Each one of these coupling relationships will also depend on the operability or functionality of the parent nodes. This is represented by y_{it}^k , which in the present work is allowed to take on a value between 0 and 1. A parent node is inoperable when $y_{it}^k = 0$, partially operable when $0 < y_{it}^k < 1$, and fully operable when $y_{it}^k = 1$. In Figures 4.1 – 4.4 below, interdependent relationships are illustrated with either inoperable or fully operable nodes. Partial operability in parent nodes is reflected by partial operability in child nodes.

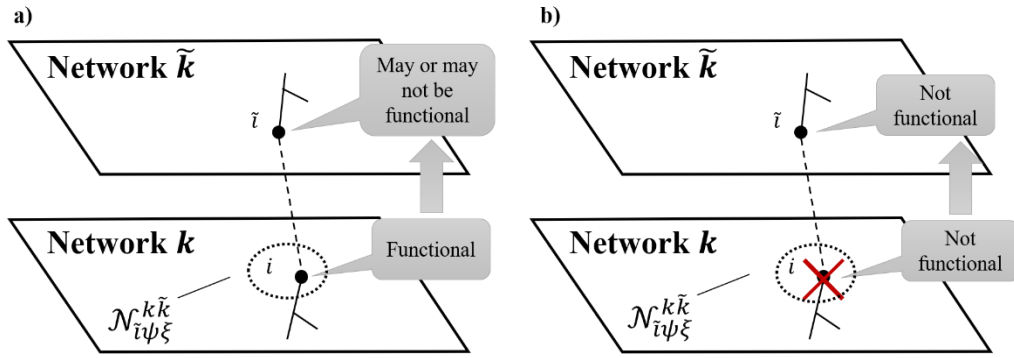

Fig. 4.1. Illustration of one2one coupling between two infrastructures k and \tilde{k} ; a) when node $i \in \mathcal{N}_{i\psi\xi}^{k\tilde{k}}$ is functional, then node $\tilde{i} \in \mathcal{N}^{\tilde{k}}$ may be functional depending on other conditions; b) when node $i \in \mathcal{N}_{i\psi\xi}^{k\tilde{k}}$ is not functional, then node $\tilde{i} \in \mathcal{N}^{\tilde{k}}$ is not functional based on the interdependent relationship

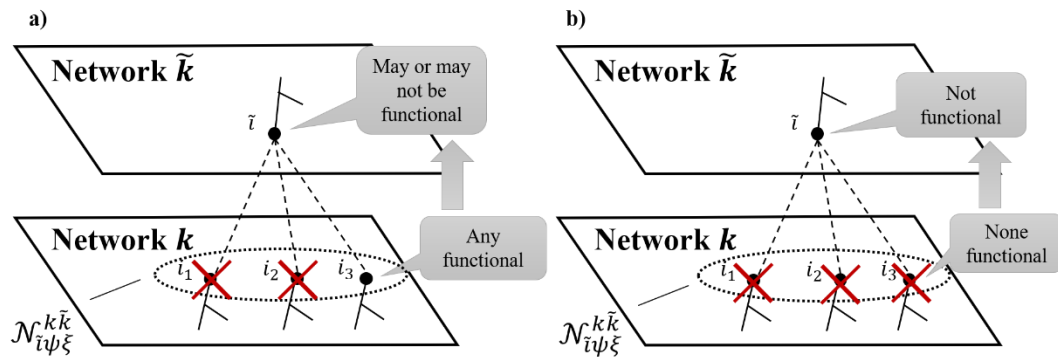

Fig. 4.2. Illustration of one2any coupling between two infrastructures k and \tilde{k} ; a) when any node(s) $i \in \mathcal{N}_{i\psi\xi}^{k\tilde{k}}$ are functional, then node $\tilde{i} \in \mathcal{N}^{\tilde{k}}$ may be functional depending on other conditions; b) when all nodes $i \in \mathcal{N}_{i\psi\xi}^{k\tilde{k}}$ are not functional, then node $\tilde{i} \in \mathcal{N}^{\tilde{k}}$ is not functional based on the interdependent relationship

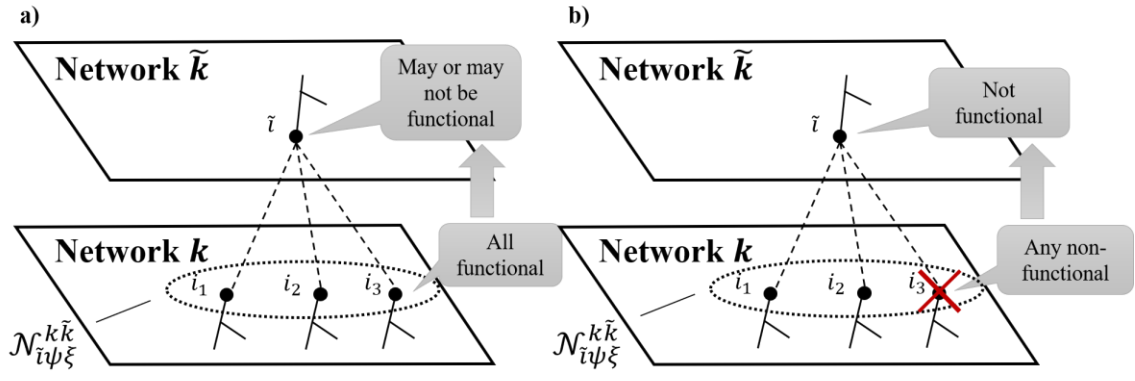

Fig. 4.3. Illustration of one2all coupling between two infrastructures k and \tilde{k} ; a) when all nodes $i \in \mathcal{N}_{i\psi\xi}^{k\tilde{k}}$ are functional, then node $\tilde{i} \in \mathcal{N}^{\tilde{k}}$ may be functional depending on other conditions; b) when any node $i \in \mathcal{N}_{i\psi\xi}^{k\tilde{k}}$ is not functional, then node $\tilde{i} \in \mathcal{N}^{\tilde{k}}$ is not functional based on the interdependent relationship

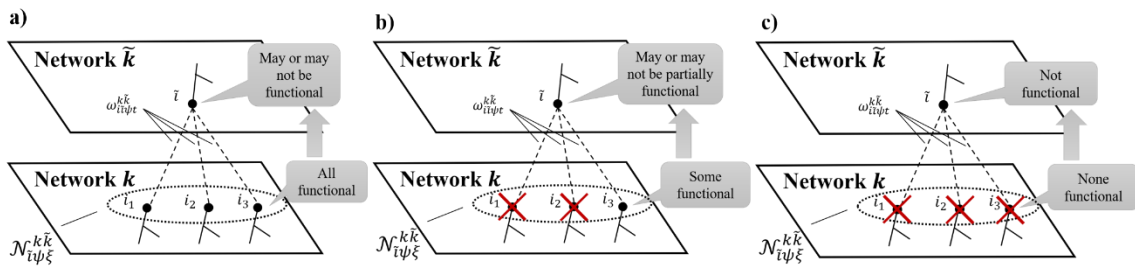

Fig. 4.4. Illustration of one2many coupling between two infrastructures k and \tilde{k} ; a) when all nodes $i \in \mathcal{N}_{i\psi\xi}^{k\tilde{k}}$ are functional, then node $\tilde{i} \in \mathcal{N}^{\tilde{k}}$ may be functional depending on other conditions; b) when some nodes $i \in \mathcal{N}_{i\psi\xi}^{k\tilde{k}}$ are functional, then node $\tilde{i} \in \mathcal{N}^{\tilde{k}}$ may be partially functional based on a weighting factor ($\omega_{i\psi t}^{k\tilde{k}}$) and depending on other conditions; c) when all nodes $i \in \mathcal{N}_{i\psi\xi}^{k\tilde{k}}$ are not functional, then node $\tilde{i} \in \mathcal{N}^{\tilde{k}}$ is not functional based on the interdependent relationship

Table 4.2 summarizes these relationships and provides the mathematical representation of the interdependency parameter. The MIP is presented following this summary. It is important to note that although parent node(s) may be functional, that does not directly equate to the child node's functionality. The child node must also have its demand met, must not be damaged, or if damaged, must be repaired to be functional; therefore, in the following figures, it is stated that the child node may or may not be functional.

Table 4.2. Interdependency coupling strategies ξ affects the interdependency parameter $\gamma_{i\psi\xi t}^{k\tilde{k}}$ by changing possible values

Coupling, ξ	Description	$\gamma_{i\psi\xi t}^{k\tilde{k}}$ *
One2one	$\tilde{i} \in \mathcal{N}^{\tilde{k}}$ is only functional when a specific singular node $i \in \mathcal{N}_{i\psi\xi}^{k\tilde{k}}$ is functional and $\mathcal{N}_{i\psi\xi}^{k\tilde{k}}$ is a singular set.	1
One2any	$\tilde{i} \in \mathcal{N}^{\tilde{k}}$ is functional when at least one node of a subset is functional, namely some node $i \in \mathcal{N}_{i\psi\xi}^{k\tilde{k}}$.	1
One2all	$\tilde{i} \in \mathcal{N}^{\tilde{k}}$ is functional only if every node from a subset $\mathcal{N}_{i\psi\xi}^{k\tilde{k}}$ is functional.	$\frac{1}{ \mathcal{N}_{i\psi\xi}^{k\tilde{k}} }$
One2many	$\tilde{i} \in \mathcal{N}^{\tilde{k}}$ depends partially on the functionality of a subset of nodes $i \in \mathcal{N}_{i\psi\xi}^{k\tilde{k}}$; each node $i \in \mathcal{N}_{i\psi\xi}^{k\tilde{k}}$ provides a fraction of the functionality.	$\frac{\omega_{i\psi t}^{k\tilde{k}}}{ \mathcal{N}_{i\psi\xi}^{k\tilde{k}} }$

* This holds for all $i \in \mathcal{N}_{i\psi\xi}^{k\tilde{k}}, \tilde{i} \in \mathcal{N}^{\tilde{k}}, k, \tilde{k} \in \mathcal{K}, \psi \in \Psi, t \in \mathcal{T}$

Of note, strict adherence to the one2all coupling relationship is most effectively achieved with binary restrictions on operability. Another method of modeling is based on

the understanding that one2all relationships are multiple one2one relationships and is discussed in greater detail in the results section.

4.3.3. MIP formulation

The following presentation describes the multiple objectives used in a weighted objective function followed by the applicable constraints.

$$\begin{aligned} \text{Cost Objective: } A = \sum_{t \in \mathcal{T}} \sum_{k \in \mathcal{K}} (\sum_{w \in \mathcal{W}^k} [\sum_{(i,j) \in \mathcal{A}'^k} (q_{ijt}^k \alpha_{ijwt}^k + a_{wt}^k p_{ij}^k \alpha_{ijwt}^k) + \\ \sum_{i \in \mathcal{N}'^k} (q_{it}^k \alpha_{iwt}^k + a_{wt}^k p_i^k \alpha_{iwt}^k)] + \sum_{l \in \mathcal{L}^k} \sum_{(i,j) \in \mathcal{A}^k} c_{ijlt}^k x_{ijlt}^k) \end{aligned} \quad (4.1)$$

$$\text{Operability Objective: } B = \sum_{t \in \mathcal{T}} \sum_{k \in \mathcal{K}} (\sum_{i \in \mathcal{N}^k} \mu_{it}^k y_{it}^k + \sum_{(i,j) \in \mathcal{A}^k} \mu_{ijt}^k y_{ijt}^k) \quad (4.2)$$

$$\text{Minimize } \mu_A A - \mu_B B. \quad (4.3)$$

Subject to

$$\sum_{j: (i,j) \in \mathcal{A}^k} x_{ijlt}^k - \sum_{j: (j,i) \in \mathcal{A}^k} x_{jilt}^k = b_{ilt}^k + x_{ilt}^{-,k} - x_{ilt}^{+,k}, \quad \forall i \in \mathcal{N}^k, l \in \mathcal{L}^k, k \in \mathcal{K}, t \in \mathcal{T}. \quad (4.4)$$

$$\sum_{l \in \mathcal{L}^k} x_{ijlt}^k \leq u_{ijt}^k y_{it}^k, \quad \forall (i,j) \in \mathcal{A}^k, i \in \mathcal{N}^k, k \in \mathcal{K}, t \in \mathcal{T}. \quad (4.5)$$

$$\sum_{l \in \mathcal{L}^k} x_{ijlt}^k \leq u_{ijt}^k y_{jt}^k, \quad \forall (i,j) \in \mathcal{A}^k, j \in \mathcal{N}^k, k \in \mathcal{K}, t \in \mathcal{T}. \quad (4.6)$$

$$\sum_{l \in \mathcal{L}^k} x_{ijlt}^k \leq u_{ijt}^k y_{ijt}^k, \quad \forall (i,j) \in \mathcal{A}^k, k \in \mathcal{K}, t \in \mathcal{T}. \quad (4.7)$$

$$y_{it}^k \leq \sum_{w \in \mathcal{W}^k} \sum_{\tau=1}^t \beta_{iw\tau}^k, \quad \forall i \in \mathcal{N}'^k, k \in \mathcal{K}, t \in \mathcal{T}. \quad (4.8)$$

$$y_{ijt}^k \leq \sum_{w \in \mathcal{W}^k} \sum_{\tau=1}^t \beta_{ijw\tau}^k, \quad \forall (i,j) \in \mathcal{A}'^k, k \in \mathcal{K}, t \in \mathcal{T}. \quad (4.9)$$

$$\sum_{t \in \mathcal{T}} \sum_{w \in \mathcal{W}^k} \beta_{iw\tau}^k \leq 1, \quad \forall i \in \mathcal{N}'^k, k \in \mathcal{K}. \quad (4.10)$$

$$\sum_{t \in \mathcal{T}} \sum_{w \in \mathcal{W}^k} \beta_{ijw\tau}^k \leq 1, \quad \forall (i,j) \in \mathcal{A}'^k, k \in \mathcal{K}. \quad (4.11)$$

$$\sum_{t \in \mathcal{T}} \sum_{w \in \mathcal{W}^k} \alpha_{iwt}^k \leq 1, \quad \forall i \in \mathcal{N}'^k, k \in \mathcal{K}. \quad (4.12)$$

$$\sum_{t \in \mathcal{T}} \sum_{w \in \mathcal{W}^k} \alpha_{ijwt}^k \leq 1, \quad \forall (i,j) \in \mathcal{A}'^k, k \in \mathcal{K}. \quad (4.13)$$

$$\beta_{iwt}^k \leq \sum_{\tau=1}^{\min[T, t-p_i^k]} \alpha_{iwt}^k, \quad \forall i \in \mathcal{N}'^k, w \in \mathcal{W}^k, k \in \mathcal{K}, t \in \mathcal{T}. \quad (4.14)$$

$$\beta_{ijwt}^k \leq \sum_{\tau=1}^{\min[T, t-p_{ij}^k]} \alpha_{ijw\tau}^k, \quad \forall (i, j) \in \mathcal{A}'^k, w \in \mathcal{W}^k, k \in \mathcal{K}, t \in \mathcal{T}. \quad (4.15)$$

$$\sum_{\tau=1}^{\min[T, t+p_i^k-1]} \sum_{i \in \mathcal{N}'^k} \alpha_{iwt}^k + \sum_{\tau=1}^{\min[T, t+p_{ij}^k-1]} \sum_{(i,j) \in \mathcal{A}'^k} \alpha_{ijw\tau}^k \leq 1 + \sum_{\tau=p_i^k+1}^t \sum_{i \in \mathcal{N}'^k} \beta_{iwt}^k + \sum_{\tau=p_{ij}^k+1}^t \sum_{(i,j) \in \mathcal{A}'^k} \beta_{ijw\tau}^k, \quad \forall w \in \mathcal{W}^k, k \in \mathcal{K}, t \in \mathcal{T}. \quad (4.16)$$

$$\sum_{i \in \mathcal{N}_{i\psi\xi}^{k\tilde{k}}} \gamma_{i\psi\xi t}^{k\tilde{k}} y_{it}^k \geq y_{it}^{\tilde{k}}, \quad \forall i \in \mathcal{N}^{\tilde{k}}, \tilde{k} \in \mathcal{K}, \psi \in \Psi, \xi \in \Xi, t \in \mathcal{T}. \quad (4.17)$$

$$y_{it}^k b_{ilt}^k \geq b_{ilt}^k + x_{ilt}^{-,k}, \quad \forall i \in \mathcal{N}_D^k, l \in \mathcal{L}^k, k \in \mathcal{K}, t \in \mathcal{T}. \quad (4.18)$$

$$0 \leq x_{ijlt}^k \leq u_{ijlt}^k, \quad \forall (i, j) \in \mathcal{A}^k, l \in \mathcal{L}^k, k \in \mathcal{K}, t \in \mathcal{T}. \quad (4.19)$$

$$x_{ilt}^{-,k} \geq 0, \quad \forall i \in \mathcal{N}^k, l \in \mathcal{L}^k, k \in \mathcal{K}, t \in \mathcal{T}. \quad (4.20)$$

$$0 \leq y_{it}^k \leq 1, \quad \forall i \in \mathcal{N}^k, k \in \mathcal{K}, t \in \mathcal{T}. \quad (4.21)$$

$$0 \leq y_{ijt}^k \leq 1, \quad \forall (i, j) \in \mathcal{A}^k, k \in \mathcal{K}, t \in \mathcal{T}. \quad (4.22)$$

$$\alpha_{iwt}^k \in \{0,1\}, \quad \forall i \in \mathcal{N}'^k, w \in \mathcal{W}^k, k \in \mathcal{K}, t \in \mathcal{T}. \quad (4.23)$$

$$\alpha_{ijwt}^k \in \{0,1\}, \quad \forall (i, j) \in \mathcal{A}'^k, w \in \mathcal{W}^k, k \in \mathcal{K}, t \in \mathcal{T}. \quad (4.24)$$

$$\beta_{iwt}^k \in \{0,1\}, \quad \forall i \in \mathcal{N}'^k, w \in \mathcal{W}^k, k \in \mathcal{K}, t \in \mathcal{T}. \quad (4.25)$$

$$\beta_{ijwt}^k \in \{0,1\}, \quad \forall (i, j) \in \mathcal{A}'^k, w \in \mathcal{W}^k, k \in \mathcal{K}, t \in \mathcal{T}. \quad (4.26)$$

Equation (4.1) includes repair and assignment costs for damaged arcs and nodes, followed by the flow costs. Equation (4.2) represents a weighted operability, which is set as a competing objective in (4.3). Basic flow balance is shown in (4.4). Multicommodity flow is capacitated and flow is restricted in three different ways based on operable start-nodes, end-nodes, and arcs in (4.5-4.7), respectively. A repaired asset can become operable, as shown in (4.8-4.9). Assets can only be repaired once and assigned to one

crew, as shown in constraints (4.10-4.11) and (4.12-4.13), respectively. Damaged assets are only repaired after they have been assigned and sufficient processing time has occurred, as shown in (4.14-4.15). Constraint (4.16) shows work crews may only be assigned to one repair task at a time.

Constraint (4.17) represents the operational interdependency constraint, which uses the interdependency parameter to determine child node operability. Constraint (4.18) suggests that a node is proportionally operable to the met amount of demand. The Constraints (4.19-4.26) represent the side constraints based on variable definitions.

4.4. Results and Discussion

This section describes the infrastructure network, the missing telecommunications data, and the results when comparing optimization results with full and partial datasets.

4.4.1. Simulated military base

Using the CLARC database as a starting point, the data was reduced to about 10% of the original size while still preserving the diversity of operations and asset types (T. Sharkey et al. 2018). This was done to recreate a representative military base with bi-directional system-to-system interdependencies inherent in the CLARC database. The resultant reduced dataset was then constructed in a multiplex fashion, reflecting nodes into layers where they had a demand, supply, or transshipment function.

An issue with the telecommunication infrastructure data was found due to only 4 of 47 different nodal asset types having any communication demand. For example, facilities such as Fire Stations, Police Stations, Schools, Hospitals, and others had no communication connections (i.e., arcs) and no demand. However, these facilities are essential in recovery operations and are controlled largely by communicating with an

Emergency Control Center (Lee et al. 2007). This issue represents partial infrastructure data within a given layer, which was overcome using two different methods.

4.4.2. Overcoming telecommunications data gap with operational interdependencies

The first method to overcome the partial telecommunication data represents working with data owners and receiving the necessary data. This was accomplished by creating a geospatial context for the reduced dataset and physically drawing each connection to create a full representation of the complete infrastructure systems. This became the full dataset. The second method used the partial data provided and created various interdependency relationships to influence operability in lieu of acquiring additional infrastructure data. This became the partial dataset with additional interdependencies. The cost to produce such interdependencies is the time to communicate with stakeholders on the actual or perceived connection and dependency to establish the appropriate coupling relationship. The number of additional interdependencies needed will be dependent on the amount of infrastructure data missing.

An example of overcoming missing infrastructure data by using an interdependency is a Fire Station that requires communication to receive 911 emergency calls. If this service is not available, then the emergency responders will not respond because they are unaware of the call. Thus, the operability of one of two telecommunication nodes (part of the partial telecommunications data) would allow the Fire Station to remain as a supply node for the fire and emergency service commodity. However, if both telecommunication nodes were inoperable, then the Fire Station would also be inoperable since this represents no ability to send and receive 911 emergency

calls. While actual systems have additional backups, this is used for illustration purposes and as a proof of concept.

This example of the Fire Station depending on the telecommunication network is an example of a one2any coupling based on a cyber (i.e., data and information flow) type interdependency. This process was applied to every node that should have a communications demand within a full dataset. The result was three variations of the network: 1) dataset with full telecommunication data, 2) dataset with partial telecommunication data and additional interdependency relationships, and 3) dataset with partial telecommunication data without additional interdependency relationships. The third set serves as a basis to judge the addition of interdependent relationships to overcome infrastructure data gaps.

4.4.3. Comparison of optimization results

Comparing the full dataset and the partial dataset with additional interdependencies shows the use of interdependencies as a viable option for overcoming partial data. The time horizon for this comparison is 12 8-hour time periods. While not the primary focus of this research, the model was programmed in GAMS v31.1.1 and used CPLEX 12.10. All tests were conducted on a desktop computer with an Intel Xeon CPU E5-1620 operating at 3.60 GHz with 16 GB of RAM. The average computational time for the tests with partial data and additional interdependencies averaged at less than 8 mins, while the tests with the full dataset averaged at 18 mins.

Table 4.3 summarizes the number of nodes, arcs, and interdependent relationships between the two different simulations. The full dataset represents 227 more nodes and arcs than the partial dataset, whereas the partial dataset with additional interdependencies

represents 102 more interdependency relationships than the full dataset. The same damage was simulated in both simulations, even though additional arcs or nodes that were not in the partial dataset could have been damaged in the full dataset.

Table 4.3. The full dataset represents more nodes and arcs, while the partial dataset represents more interdependency relationships

Feature	Full Dataset	Partial Dataset
Nodes	507	432
Arcs	886	734
Interdependencies	123	225

The two different datasets were evaluated over varying objective function weights, establishing Pareto optimal values or a Pareto front. Due to the disparity in the number of assets, the overall operability objective value for the full dataset was 1.25 times higher than that of the partial dataset across the Pareto fronts. There was one anomaly when cost was weighted the most and operability the least (i.e., $\mu_A = 0.9, \mu_B = 0.1$), which resulted in the operability objective function value being 1.57 times greater than the partial dataset. After acknowledging the slight difference in the magnitude of the operability objective function values, the overall trends were identical.

In the case with balanced objective functions (i.e., $\mu_A = \mu_B = 0.5$), the full dataset showed an increase in operability from 65.8%, representing immediate operability following the disruption, to 68.1% within the first four time periods. Then the model showed a significant jump in operability at time period 5 to 89.4%, where it remained for the time periods being evaluated. This signifies that the bulk of the optimal recovery trying to balance operability and cost was achieved by time period 5, or 40 hours

following the disruption, based on 8-hr time periods. The partial dataset showed similar trends, with slight deviation in the percent operable. The partial dataset showed an increase in operability of 65.6% to 68.2% in the first four time periods and an increase to 91.8% at time period 5 and beyond. The partial dataset deviation from the full dataset in the first four time periods ranged from -0.2% to +0.3%. With the jump in operability at time period 5 the percent deviation also increased to +2.6% from time period 5 on. Partial data without the additional interdependencies underestimated the recovery from as great as -6.0% to as little as -3.8%, never achieving as accurate results as the partial dataset with additional interdependencies. Figure 5 illustrates how the partial dataset with an increased number of interdependency relationships closely approximates the operability of the system during recovery. The final operability percentage in these scenarios ranged from 86.1% to 91.8% and didn't progress to 100% operability due to the presence of redundant flow pathways and the desire to balance cost and operability. Additionally, nodes and arcs that have extremely low value, denoted by μ_{it}^k or μ_{ijt}^k , and high costs repair costs, denoted by q_{it}^k or q_{ijt}^k , tend to be excluded from optimal results. This can be beneficial to emergency repair crews to ensure emphasis on the critical aspects of the system, prior to addressing non-critical components.

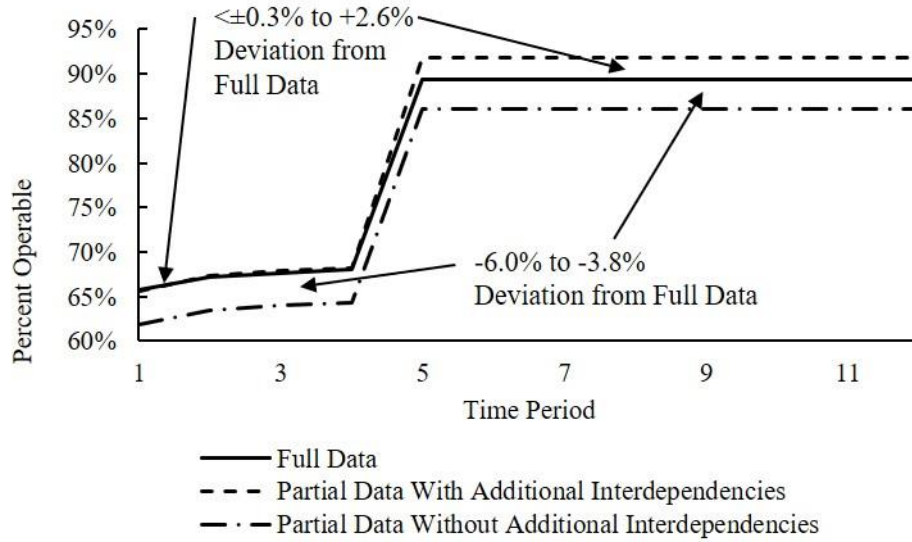

Fig. 4.5. Partial data simulation with additional interdependencies more closely approximated a full dataset than the partial data without additional interdependencies

The partial dataset employed only one2one and one2any coupling strategies since this most accurately reflected the same relationships that existed in the full dataset. The partial dataset scenario was also run by modifying the MIP to restrict the operability variables, y_{it}^k and y_{ijt}^k , to binary values with no significant changes to the operability objective value, being within 3% at the greatest point of deviation. In fact, the strict adherence to the one2one, one2any, and one2all coupling strategies may be best seen when operability is modeled as binary variables. If operability is modeled as binary variables, the same formulation as presented above holds for all coupling strategies except one2many, which inherently is incompatible with binary operability variables.

In contrast, the inclusion of all the coupling strategies with a non-binary operability variable, as in the current work, also becomes problematic when desiring strict adherence to all the coupling strategies. The use of non-binary operability variables

means that child node partial operability is possible based on parent node partial operability. Effectively this creates an upper bound on child node operability based on full or partial parent node operability and the associated coupling strategy. A child node in one2one relationships has an upper bound based on the parent node operability. A child node in one2any relationships may be fully operable so long as one node is fully operable or the sum of all parent nodes' partial operability amount to one or more. A child node in one2all relationships has an upper bound of some fraction of parent node partial operability. A child node in one2many relationships has an upper bound of some partial operability based on the sum of partial operability of the parent nodes.

A comparative example between binary and non-binary operability variables for one2all relationships illustrates the difference. A one2all coupling between three parent nodes and one child node results in an inoperable child node if any one of the three parent nodes is inoperable when operability is binary. In the case of non-binary operability, the node may experience operability up to 2/3 operability based on one node being inoperable and the other two being fully operable. To achieve strict adherence to the one2all coupling strategy with non-binary variables, a modification is made to constraints (4.17) by removing the summation over the set $\mathcal{N}_{i\psi\xi}^{k\bar{k}}$. This can be accomplished by employing conditional constraint generation when programming the MIP.

Despite the need to slightly adjust the MIP presentation to accommodate one2all relationships, the use of non-binary operability variables adds a significant level of reality to the simulation. In very few instances will the termination of telecommunication services result in complete inoperability. Therefore, partial operability is a closer approximation to reality. This also allows the use of a pseudo node which can establish a

baseline operability level regardless of the loss of service. For example, if an industry is still 80% operable with the loss of internet and telephone services. A one2many relationship can exist between $\tilde{i} \in \mathcal{N}^{\tilde{k}}$ and any number of nodes $i \in \mathcal{N}^k$, with 80% of the weight times the cardinality of the set $\mathcal{N}_{ii\psi\xi}^{k\tilde{k}}$ for some interdependency type $\psi \in \Psi$ residing in the relationship with pseudo node $i^* \in \mathcal{N}^k$.

An additional scenario was built based on the partial dataset, which included a partial operability baseline of 80% despite lack of telecommunication services except for the emergency responders, which rely on telecommunications to send and receive 911 emergency calls. This scenario resulted in a near-perfect match because only three facilities in the power infrastructure system met the conditions to have 80% operability versus being reduced to zero. A different damage scenario could highlight this better, but consistency for comparison was chosen over introducing a different damage scenario.

This shows the ability to incorporate all the various coupling strategies and leverage the one2many relationship to help model complex relationships that result in some impact to operability but do not render a node inoperable. This effectively assigns a lower bound to operability based on interdependencies.

During the construction of these datasets, it was assumed and then shown in analysis that this model's applicability only worked if the actual known telecommunication nodes were damaged or inoperable. Suppose the service disruption was from a telecommunication node in the partial and full datasets downstream to the point of interest, thereby only belonging to the full dataset. In that case, this method could

not show similar disruption as can be seen in the full dataset. This lack of granularity points to the limitations of using interdependencies in lieu of a full dataset.

4.5. Conclusion

This paper detailed issues concerning access to data and then highlighted how interdependencies could be leveraged to overcome partial infrastructure data. This was shown in using a representative full and partial dataset for a military base-sized system of networks. The results showed comparable operability projections between the two methods. Additionally, some flexibility was gained to model complex interactions by using more robust interdependencies. The modification to commonly used interdependency parameters integrated multiple interdependency types and coupling strategies, which had not been done as an inherent part of a model before this work. Some limitations exist in not capturing the same granularity of knowledge on damaged assets that can be gleaned from full datasets.

V. The Base Interdependent Infrastructure Recovery Model (BIIRM)¹

5.1. Introduction

Infrastructure systems are becoming more complex and increasingly interdependent. These interdependencies have implications on how best to recover infrastructures following a disruption. Complexity due to interdependencies is increasing due to trends in urbanization and incorporation of cyber-physical systems (Chee and Neo 2018; Jenkins et al. 2017; Thong et al. 2016). Efforts such as City of the Future and Industry 4.0 drive complex interconnections in order to realize the enhanced service level being advertised (ASCE 2019; Hanley et al. 2019). The complexity is exacerbated by the different types of interdependencies and dimensions used to describe and analyze infrastructure networks (Haines et al. 2007; Rinaldi et al. 2001). All of this is driving higher and higher degrees of infrastructure interdependence.

A small sampling of several large-scale infrastructure service disruptions over the last two decades is sufficient to highlight the interdependent nature of the underlying infrastructure networks. From 2000 to 2001, disruption in the electrical power grid in California ended up impacting the oil and gas industry, including the provision of natural gas back to the power-generating elements of the electrical grid. This disruptive event showed the propagation of failure in one infrastructure system to another infrastructure system and then further degradation to the original system (Fletcher 2001). The September 2001 terrorist attack on the World Trade Center highlighted a non-physical

¹ The contents of this chapter were independently submitted for publication by Moore, Schuldt, Grandhi, and Jacques to ASCE's *Journal of Infrastructure Systems* on 11 May, 2021. The submitted article was titled "Impact of Operational and Restoration Interdependencies on Recovery Time, Cost, and Disruptive Effect in Multilayered Infrastructure Networks."

interdependence between administrative policy and the aviation industry's ability to provide services, which ultimately resulted in \$1.4 billion in lost revenue due to a three-day airport closure (Faturechi et al. 2014). In 2003, a large scale blackout showed how an initial fault in the power lines combined with a fault in the alarm system (i.e., information control system) caused additional failures in the electrical distribution grid, resulting in over 50 million people in the United States and Canada without power for up to two days (Minkel 2008). Natural disasters to include 2005 Hurricane Katrina in Florida and Louisiana, 2011 Tōhoku earthquake in Japan and subsequent Fukushima nuclear disaster, 2012 Superstorm Sandy in New Jersey and New York, 2017 Hurricane Harvey in Texas, and 2017 Hurricane Maria in Puerto Rico have time and again showcased the interdependent nature of infrastructure systems in the provision and recovery of infrastructure services (Comerio 2014; NIAC 2018).

This paper provides an overview of relevant modeling efforts focused on the recovery of interdependent infrastructure systems. This paper establishes the need for a model that simultaneously incorporates multiple interdependency relationships, which impact infrastructure operations and restoration following a disruptive event. This paper makes two contributions to the academic literature. First, a mixed-integer program (MIP) is proposed as a way to integrate the three most common objective functions found in infrastructure restoration literature in a multi-objective construct and the nine different interdependency subtypes into a single model. Second, the proposed model is tested against a modified realistic dataset and a simulated natural disaster. The damage scenario is tested in various situations, both altering the weights of the multiple objectives and

varying the inclusion of interdependency relationships. The results will demonstrate the value of including multiple interdependencies when modeling recovery operations.

5.2. Literature Review

Efforts to incorporate more than one infrastructure in modeling have been increasing over the last twenty years. These interdependent infrastructure recovery modeling improvements are crucial to understanding the importance of interdependency types, coupling strategies, and principal objectives of recovery operations. Traditionally, infrastructure systems have been modeled as independent systems with little evaluation of one infrastructure system's effects on another (Buldyrev et al. 2010; Lee et al. 2007). However, this has since become an emerging field of study (Bianconi 2018). This increase in examination of multiple infrastructures within a given model is critical to defining and quantifying the effects of interdependent relationships.

The application of network-based models in restoration is not new, but progress toward interdependent recovery is still in a nascent stage. Guha et al. (1999) looked at the recovery of power systems after disruptions. Ang (2006) likewise studied disrupted power systems and sought to find optimal recovery strategies. Nurre et al. (2012) developed an integrated network design and scheduling problem, which others have similarly built upon (Cavdaroglu et al. 2013; Iloglu and Albert 2018). Iloglu and Albert (2020) used a maximal covering problem construct to evaluate restoration activities. While these models show continual improvement in network modeling to address restoration, they were not specifically focused on interdependent infrastructure recovery. Although not the primary focus of this paper, some models have focused on interdependency's role on preventive interventions which could be a promising

application of this research (Benmokhtar et al. 2020; Kammouh et al. 2021; Robert Professor et al. 2013). A brief overview of interdependency types is essential before examining interdependent infrastructure recovery models.

5.2.1. Types of interdependencies

Interdependency relationships that are of interest to this study can be classified as operational interdependencies (affecting the operations of infrastructure networks) and restoration interdependencies (affecting the restoration of disrupted infrastructure networks). Rinaldi et al. (2001) expressed a comprehensive set of operational interdependencies subtypes, including physical, cyber, logical, and geospatial interdependencies. Physical relates to the flow of commodities and asset functionality, cyber relates to information flow through the telecommunications network, geospatial is based on proximity, and logical is any other type of relationship. Using these definitions, Ouyang (2014) categorized 10 critical infrastructure interdependencies based on historical disaster scenarios. During this same analysis, no other set of operational interdependency subtype definitions could categorize all 10 historical examples. Rinaldi et al.'s four interdependency subtypes largely affect the operations of infrastructure networks and constitute the operational interdependency types used in the present work.

Sharkey et al. (2016) identified five different restoration interdependencies subtypes that only influence the recovery of disrupted networks and deal with recovery task scheduling and resource management. These include traditional precedence, effectiveness precedence, options precedence, time-sensitive options, and competition for resources. Traditional precedence requires task A in network one to be accomplished before task B in network two can be started (e.g., de-energize power lines before tree

cleanup). Effective precedence means if task A in network one has not been completed, work on task B in network two can continue at a slower rate or an extended processing time (e.g., restoring power to pump house speeds flooded road recovery versus pumping by truck). Options precedence means at least one task of two or more in a network(s) must be completed before task B in a different network is allowed to start (e.g., either power is restored or a generator is brought before a water pump can be used to clear floodwater). Time-sensitive options must be done by a certain deadline, or an additional recovery task will be generated (e.g., restore power to lift station by a certain time or a cleanup task will be needed). Competition for resources can affect restoration activities (e.g., one generator needed at two geographically separated locations). The restoration interdependency subtype of competition for resources is not considered in this work based on the assumption of sufficient resources due to the minimal damage event simulated; however, an example of this type of relationship is expressed in the work of González et al. (2016).

Additionally, Gonzalez et al. (2016) also identified a way in which the geospatial interdependency can be construed as a restoration interdependency by taking into consideration cost savings from scheduling adjacent work and only expending resources once for site preparation (e.g., excavation for the repair of co-located utilities that were both damaged in an earthquake). Four of the five restoration interdependency subtypes (excluding competition for resources) identified by Sharkey et al. (2016), plus the geospatial repair subtype identified by Gonzalez et al. (2016), affect the restoration of interdependent infrastructure networks and comprise the restoration interdependencies in this work.

5.2.2. Relevant interdependent infrastructure recovery modeling efforts

Although interdependent infrastructure recovery modeling is still an emerging science, some significant progress has been achieved. Lee et al. (2007) developed the interdependent layer network (ILN) model, which sought to find the least cost recovery strategy by minimizing the cost of flow, the unmet weighted demand, and service disruption caused by interdependencies. Using a MIP, this model generated optimal recovery strategies while considering physical, logical, and geospatial operational interdependencies; however, it did not include any restoration interdependencies. The ILN model has been influential and other authors have used and modified it for various interdependent infrastructure recovery applications (Cavdaroglu et al. 2013; Loggins and Wallace 2015).

Sharkey et al. (2015) built upon the model proposed by Cavdaroglu et al. (2013) and Nurre et al. (2012) to develop the interdependent integrated network design and scheduling (IINDS) problem. This model's objective was to understand the timing of recovery, scheduling repairs with parallel workgroups, and maximizing the network's cumulative performance over a finite period of time. This work added several unique elements, the most important to the present work is the identification and addition of restoration interdependencies, of which only traditional precedence and time-sensitive options were modeled. This model was limited by the absence of three restoration interdependency subtypes – effective precedence, options precedence, and geospatial repair – and two operational interdependency subtypes – logical and cyber.

Gonzalez et al. (2016) developed what they called the interdependent network design problem (INDP) and other variations to include the consideration of time

dependency, iterative heuristics, and stochastics based on parameter uncertainty (González 2017). These models seek to find the least cost recovery strategies. These models can handle multiple operational interdependency types based on certain coupling strategies of interdependent layers, though only physical and geospatial operational interdependency subtypes were used in the problem instances. This model's limitations include the lack of cyber and logical operational interdependency subtypes, the lack of explicit formulation to handle various interdependency subtypes simultaneously, and the exclusion of most restoration interdependency subtypes.

Almoghathawi et al. (2019) developed a multi-objective restoration model seeking to maximize resilience while finding the least-cost recovery strategy. They analyzed power and water systems by using a fictional dataset generated using algorithms. The primary advantage of this model was the explicit inclusion of a resilience measure in the objective function that allowed the future exploration of the balance between “withstanding a disruption” and “recovering from a disruption.” This model's limitations consist of considering only physical operational interdependencies, no restoration interdependencies, and using a fictitious dataset.

None of the aforementioned models address the multiple objectives and listed operational and restoration interdependencies (Table 5.1). Every model examined included one or more of the three primary objective functions. The most likely reasons that not all models have included all three primary objectives are due to the facts that 1) models are typically purpose-built for some stakeholder-specific objectives and 2) there has not been a formalization of these primary objectives found in restoration literature. The most common objective between these models was least-cost recovery, followed by

minimal recovery time and minimal disruptive effect. Lee et al. (2007) included cost, unmet demand, and weighted time in one objective function, which essentially combined elements of all three objectives. Almoghathawi et al. (2019) used two objectives but included an element of weighted time, which is considered as combining elements of all three objectives.

Table 5.1. No model currently addresses the three most common objectives and all operational and restoration interdependency subtypes

Criterion	Model1 ^a	Model2 ^b	Model3 ^c	Model4 ^d	Model5 ^e	BIIRM
<i>Objective Function</i>						
Least cost	✓	-	✓	✓	✓	✓
Recovery time	✓	✓	-	-	✓	✓ ^f
Disruptive effect	✓	✓	-	-	✓	✓
<i>Operational Interdependency</i>						
Physical	✓	✓	✓	✓	✓	✓
Cyber	-	-	-	-	-	✓
Logical	✓	-	-	-	-	✓
Geospatial	✓	✓	✓	✓	-	✓
<i>Restoration Interdependency</i>						
Traditional precedence	-	✓	-	-	-	✓
Effectiveness precedence	-	-	-	-	-	✓
Options precedence	-	-	-	-	-	✓
Time-sensitive options	-	✓	-	-	-	✓
Geospatial repair	-	-	✓	✓	-	✓

^a Lee et al. (2007); ^b Sharkey et al. (2015); ^c González et al. (2016); ^d González (2017); ^e Almoghathawi et al. (2019); ^f included by virtue of time dependent indexing

Least cost, repair time, and disruptive effect are not the only objectives that are possible in recovery operations, they have a striking similarity to the construction or project management trilemma of cost, quality, and time. While there are critics of this approach (Atkinson 1999), it has guided project management for over 70 years and

perhaps has influenced these restoration objectives. There is validity in seeking least cost recovery strategies since financial resources are finite. Optimizing repair time is an objective that is critical for time-sensitive operations, such as defense sector infrastructure with mandated uptimes and limited uninterrupted power supply (Theony 2020). Minimizing disruptive effect of critical assets ensures that infrastructure is supporting life-saving functions (O'Rourke 2007; White et al. 2016). Therefore, these common objective functions are assumed to have utility and value to stakeholders involved in recovery operations.

The models listed in Table 5.1 don't fully address all interdependency subtypes for four reasons. First, the models have focused on some of the operational interdependency subtypes and not considered the restoration-specific interdependency subtypes since they were formalized only within the last five years (González et al. 2016; Sharkey et al. 2016) and have not been integrated into all restoration models. Second, exploration of operational interdependency subtypes has been limited by data accessibility issues, which continues to be a problem within interdependent infrastructure restoration modeling (Buldyrev et al. 2010; National Infrastructure Advisory Council (NIAC) 2018; Ouyang 2014; Peretti 2014; Rinaldi et al. 2001). Third, different model purposes and goals have limited the need to include all the various types of interdependency subtypes. Some of the models mentioned could have possibly been adapted or expanded to include additional interdependency subtypes but how they were presented in the literature was insufficient to incorporate all the various subtypes. The limitation of inherently incorporating all known interdependency subtypes is exacerbated by inconsistent nomenclature and categorization. For example, Lee et al. (2007) used a

different set of operational interdependency subtypes, which can be considered as both physical and logical from the subtypes used in this study. These problems have led to no other model making the integration of all known interdependency subtypes an inherent part of the model.

The present work seeks to address the absence of a model which considers all the various interdependency types identified within the context of the most common objective functions. The proposed model is designated as the base interdependent infrastructure recovery model (BIIRM). The BIIRM provides a starting point for future models that seek to incorporate interdependent infrastructure analysis in modeling and simulation efforts.

5.3. Notation and Formulation of the BIIRM

This section lays out the MIP development, which is denoted as the base interdependent infrastructure recovery model (BIIRM). The section starts by describing the general BIIRM notation to include sets, variables, and parameters. The section then describes the three BIIRM objectives followed by three sets of constraints. The first main section of constraints is focused on network flow of commodities and scheduling damage repair. The next section of constraints incorporates operational interdependencies. The final section of constraints incorporates restoration interdependencies.

The multilayered nature of the BIIRM employs both multiplex structuring (i.e., one-to-one nodal reflections in various layers) and multi-slice structuring (i.e., adds element of time) (Bianconi 2018). The combination of these multilayered structures allowed for the analysis of operational and restoration interdependencies. These multilayered structures will be employed for a network comprised of 150 key

infrastructure assets and the associated linear assets to establish connectivity across five infrastructure layers. This network is described in detail following the formulation of the BIIRM.

5.3.1. General notation

To describe the overall system, let $\mathcal{G}(\mathcal{N}, \mathcal{A})$ be a digraph consisting of a set of nodes, \mathcal{N} and a set of arcs, \mathcal{A} indexed as i and (i, j) , respectively. To further define this digraph, sets must be defined regarding infrastructure layers, commodities, node and arc subsets, work crews, spaces, operational interdependency types, and time periods.

Let \mathcal{K} be a set of infrastructure layers constructed in a multiplex fashion and let \mathcal{L}^k be a subset of commodities that are restricted to flow only within the infrastructure layer $k \in \mathcal{K}$, where $\cup_{k \in \mathcal{K}} \mathcal{L}^k = \mathcal{L}$. Similarly, let \mathcal{N}^k and \mathcal{A}^k be subsets of nodes and arcs, respectively, that play an active role in the flow of commodities within a given infrastructure layer $k \in \mathcal{K}$, meaning $\cup_{k \in \mathcal{K}} \mathcal{N}^k = \mathcal{N}$ and $\cup_{k \in \mathcal{K}} \mathcal{A}^k = \mathcal{A}$. Also, let \mathcal{N}'^k and \mathcal{A}'^k be the damaged subset of nodes and arcs respectively, where $\mathcal{N}'^k \subseteq \mathcal{N}^k$ and $\mathcal{A}'^k \subseteq \mathcal{A}^k$. Let there be a work crew $w \in \mathcal{W}^k$ who work within a given infrastructure layer $k \in \mathcal{K}$, where $\cup_{k \in \mathcal{K}} \mathcal{W}^k = \mathcal{W}$. Let there be a collection of spaces $s \in \mathcal{S}$ that are mutually exclusive and comprehensive of the region of interest, where every node is in one and only one space, and every arc is in at least one space. Therefore, the set of spaces \mathcal{S} helps define the geospatial operational interdependencies. Let Ψ be a set of other operational interdependency types, including physical, cyber, and logical. This additional indexing based on operational interdependency subtype is what allows for layered

relationships to exist between node pairs to handle complex interdependent operations.

Also, \mathcal{T} is the set of time periods used in the evaluation of the model.

The preceding sets deal with the model at large, but specific interdependency sets are also required to describe the various relationships. In all restoration interdependency relationships included in this model, there is assumed to be a parent-to-child relationship, where the child task in infrastructure layer $\tilde{k} \in \mathcal{K}$ depends on the parent task(s) in infrastructure layer $k \in \mathcal{K}$. Either a node or arc may play the role of parent or child, thus creating node-to-node, node-to-arc, arc-to-node, and arc-to-arc relationships, indexed as (i, \tilde{i}) , $(i, (\tilde{i}, \tilde{j}))$, $((i, j), \tilde{i})$, and $((i, j), (\tilde{i}, \tilde{j}))$ respectively. These parent-to-child relationships are defined as node-based or arc-based depending on the parent asset type being a node or arc, respectively. Therefore, for the four different restoration interdependency subtypes defined by Sharkey et al. (2015) that are used in this model, we have node-based traditional precedence (*NTP*), effectiveness precedence (*NEP*), options precedence (*NOP*), and time-sensitive options (*NTS*). There are equivalent sets for the arc-based relationships designated as sets *ATP*, *AEP*, *AOP*, and *ATS*. These eight different sets provide a comprehensive manner in which to describe four of the five restoration interdependency subtypes used. These special sets are similar to those described by Sharkey et al. (2015), even though only two restoration-specific subtypes were fully used. The geospatial repair subtype is described based on the repair of an arc or node. The presentation of the mathematical formulation for the restoration interdependency constraints is abbreviated by only explaining the relationships used in the scenario described later.

There are decision variables within the model responsible for the flow of material, assigning recovery tasks, completing recovery tasks, operability, and recovery task location. The flow of materials is designated by x_{ijlt}^k , which is the flow of commodity $l \in \mathcal{L}^k$ across arc $(i, j) \in \mathcal{A}^k$ within infrastructure layer $k \in \mathcal{K}$ at time period $t \in \mathcal{T}$. Assignment of recovery tasks is designated by a binary variable α_{iwt}^k or α_{ijwt}^k [Greek alpha], which is equal to 1 if work crew $w \in \mathcal{W}^k$ is assigned to start work at time period $t \in \mathcal{T}$ and continue working until finished repairing node $i \in \mathcal{N}^k$ or arc $(i, j) \in \mathcal{A}^k$ respectively within infrastructure $k \in \mathcal{K}$, and 0 otherwise. In an effectiveness precedence relationship, there is an additional binary assignment variable denoted as $\alpha_{i_e wt}^k$ or $\alpha_{ij_e wt}^k$ [Greek alpha], which employs a subscript e on the node or arc index to denote an assignment with an extended processing time. The completion of a recovery task is denoted by the binary variable β_{iwt}^k or β_{ijwt}^k , which is equal to 1 if node $i \in \mathcal{N}^k$ or arc $(i, j) \in \mathcal{A}^k$ in infrastructure layer $k \in \mathcal{K}$ is completed by work crew $w \in \mathcal{W}^k$ at the start of time period $t \in \mathcal{T}$, and 0 otherwise. The binary variable y_{it}^k or y_{ijt}^k denotes the operability of a node or arc, which is equal to 1 if node $i \in \mathcal{N}^k$ or arc $(i, j) \in \mathcal{A}^k$ in infrastructure layer $k \in \mathcal{K}$ is operable by the start of time period $t \in \mathcal{T}$, and 0 otherwise. Operability is controlled by whether the node or arc is damaged, the repair is completed, and any operational interdependencies with other networks. The location of recovery activities is controlled by binary variable z_{st} , which is equal to 1 if a recovery task (node- or arc-based) is started in space $s \in \mathcal{S}$ in time period $t \in \mathcal{T}$.

Parameters within the model can be divided into those that affect the cost, flow, scheduling, operational interdependencies, and restoration interdependencies. Cost

parameters can be further delineated into site preparation, repair, assignment, and flow costs. The site preparation cost is defined as g_{st} , which represents the average cost of preparing a site $s \in \mathcal{S}$ at time period $t \in \mathcal{T}$. The repair costs are defined for all $k \in \mathcal{K}$ and $t \in \mathcal{T}$ as q_{it}^k and q_{ijt}^k for any node $i \in \mathcal{N}^k$ and arc $(i, j) \in \mathcal{A}^k$, respectively, which is generated from a unit cost table based on the type of facility and an assumed reference size (DoD 2020). The assignment cost represents the national average for a general laborer working on that type of infrastructure layer $k \in \mathcal{K}$ at time period $t \in \mathcal{T}$ and is defined as a_{wt}^k [Latin a] for every work crew $w \in \mathcal{W}^k$. The flow cost, c_{ijlt}^k , is based on the infrastructure owner's cost for operations and maintenance of flowing commodity $l \in \mathcal{L}^k$ along arc $(i, j) \in \mathcal{A}^k$ of infrastructure $k \in \mathcal{K}$ at time period $t \in \mathcal{T}$.

The flow and scheduling parameters are defined for supply and demand, flow capacity, normal processing time, and extended processing time. For all $k \in \mathcal{K}$ and $t \in \mathcal{T}$ the supply or demand of commodity $l \in \mathcal{L}^k$ of a particular node $i \in \mathcal{N}^k$ is defined by b_{ilt}^k , where if $b_{ilt}^k < 0$ it is a demand node, if $b_{ilt}^k = 0$ it is a transshipment node, and if $b_{ilt}^k > 0$ it is a supply node. For ease of notation, subscripts are added to \mathcal{N}^k to denote a further subset indicating demand, transshipment, and supply by \mathcal{N}_D^k , \mathcal{N}_T^k , and \mathcal{N}_S^k , respectively when necessary. Flow is capacitated through an arc $(i, j) \in \mathcal{A}^k$ by u_{ijt}^k for all shared commodities $l \in \mathcal{L}^k$ within a given infrastructure layer $k \in \mathcal{K}$ at time period $t \in \mathcal{T}$. For all $k \in \mathcal{K}$ each damaged node $i \in \mathcal{N}^k$ or arc $(i, j) \in \mathcal{A}^k$ has an associated normal processing time, p_i^k or p_{ij}^k , respectively. Similarly, there is an extended processing time for those nodes and arcs that are included in an effectiveness precedence

relationship defined as e_i^k or e_{ij}^k , respectively. These sets, variables, and parameters provide the background to discuss the formulation and development of the BIIRM.

5.3.2. Infrastructure recovery objectives

The literature focuses on minimizing cost, disruptive effect, and repair time. Costs associated with recovery of a disrupted system include repair costs, assignment costs, site preparation costs, and costs of flowing commodities. The equation associated with the cost objective follows.

$$\begin{aligned}
 \text{Cost Objective: } A = & \sum_{t \in \mathcal{T}} \left(\sum_{s \in \mathcal{S}} g_{st} z_{st} + \right. \\
 & \sum_{k \in \mathcal{K}} \left(\sum_{w \in \mathcal{W}^k} \left(\sum_{(i,j) \in \mathcal{A}^k} (q_{ijt}^k (\alpha_{ijwt}^k + \alpha_{ije_{wt}}^k) + a_{wt}^k (p_{ij}^k \alpha_{ijwt}^k + e_{ij}^k \alpha_{ije_{wt}}^k)) \right) + \right. \\
 & \left. \left. \sum_{i \in \mathcal{N}^k} (q_{it}^k (\alpha_{iwt}^k + \alpha_{ie_{wt}}^k) + a_{wt}^k (p_i^k \alpha_{iwt}^k + e_i^k \alpha_{ie_{wt}}^k)) \right) \right) + \sum_{l \in \mathcal{L}^k} \sum_{(i,j) \in \mathcal{A}^k} c_{ijlt}^k x_{ijlt}^k \left. \right). \tag{5.1}
 \end{aligned}$$

The cost objective has 10 terms, as shown in (5.1). The first term is the cost of site preparation. The second and third terms are the arc-based repair costs associated with either normal or extended recovery assignments, respectively. The fourth and fifth terms are the assignment costs for arc-based work, depending on whether a normal or extended processing time is used. The sixth and seventh terms are the node-based repair costs, and the eighth and ninth terms are the node-based assignment costs similar to the arc-based ones. The tenth term is the flow cost of commodities throughout the entire network.

The second primary objective is minimizing disruptive effect and is shown in (5.2). Various forms of this objective are presented in literature which seek to ensure demand is met at critical nodes or that critical nodes and arcs are operational. In contrast to using only unmet demand, which restricts applicability to a subset of nodes, the

inclusion of all nodes and arcs based on operability allows the model to target critical assets that are not strictly listed as a demand node. Therefore, the surrogate used for minimizing disruptive effect is to maximize the operability at the critical nodes and arcs based on the nodal weight, μ_{it}^k , and arc weight, μ_{ijt}^k . Weights are assigned by a collaboration of stakeholders to reflect the value infrastructure or infrastructure services provided.

$$\text{Disruption Objective: } B = \sum_{t \in \mathcal{T}} \sum_{k \in \mathcal{K}} \left(\sum_{i \in \mathcal{N}^k} \mu_{it}^k y_{it}^k + \sum_{(i,j) \in \mathcal{A}^k} \mu_{ijt}^k y_{ijt}^k \right). \quad (5.2)$$

The third primary objective is reducing the time required to recover critical assets. Time is integrated into nearly all the variables and parameters, which is a similar integration of this objective, as shown in the works of Lee et al. (2007) and Almoghathawi et al. (2019). The time index allows for capturing the importance of time and ensuring rapid recovery of critical assets. Of note, the nodal and arc weight parameters that signify an asset's criticality are also indexed by time, thus allowing a user to define when certain critical assets are most needed or relevant in the recovery process.

The two explicitly defined objectives A and B , along with the implicit time objective, are weighted in a combined overall objective function. This combination enables recovery personnel to tailor recovery to emphasize cost, operability, or speed. Having described the notation and objective functions, the BIIRM can be presented. This will be done by introducing the overall objective, the network flow and scheduling constraints, the operational interdependency constraints, and the restoration interdependency constraints.

5.3.3. Network flow and scheduling

The following is the summarized version of the BIIRM based mainly on node-based constraints for the network flow and scheduling portion. Any additional arc-based constraints are noted where applicable but are shown in Appendix D. Restoration interdependency constraints use the applicable asset-to-asset relationship, which is defined in each subsection with additional relationships show in Appendix D.

$$\text{Minimize } \mu_A A - \mu_B B. \quad (5.3)$$

Subject to

$$\sum_{j:(i,j) \in \mathcal{A}^k} x_{ijlt}^k - \sum_{j:(j,i) \in \mathcal{A}^k} x_{jilt}^k = b_{ilt}^k + x_{ilt}^{-,k} - x_{ilt}^{+,k}, \quad \forall i \in \mathcal{N}^k, l \in \mathcal{L}^k, k \in \mathcal{K}, t \in \mathcal{T}. \quad (5.4)$$

$$\sum_{l \in \mathcal{L}^k} x_{ijlt}^k \leq u_{ijt}^k y_{it}^k, \quad \forall (i,j) \in \mathcal{A}^k, i \in \mathcal{N}^k, k \in \mathcal{K}, t \in \mathcal{T}. \quad (5.5)$$

$$\sum_{l \in \mathcal{L}^k} x_{ijlt}^k \leq u_{ijt}^k y_{jt}^k, \quad \forall (i,j) \in \mathcal{A}^k, j \in \mathcal{N}^k, k \in \mathcal{K}, t \in \mathcal{T}. \quad (5.6)$$

$$\sum_{l \in \mathcal{L}^k} x_{ijlt}^k \leq u_{ijt}^k y_{ijt}^k, \quad \forall (i,j) \in \mathcal{A}^k, k \in \mathcal{K}, t \in \mathcal{T}. \quad (5.7)$$

$$y_{it}^k \leq \sum_{w \in \mathcal{W}^k} \sum_{\tau=1}^t \beta_{iw\tau}^k, \quad \forall i \in \mathcal{N}'^k, k \in \mathcal{K}, t \in \mathcal{T}. \quad (5.8)$$

$$\sum_{t \in \mathcal{T}} \sum_{w \in \mathcal{W}^k} \beta_{iw\tau}^k \leq 1, \quad \forall i \in \mathcal{N}'^k, k \in \mathcal{K}. \quad (5.9)$$

$$\sum_{t \in \mathcal{T}} \sum_{w \in \mathcal{W}^k} \alpha_{iw\tau}^k \leq 1, \quad \forall i \in \mathcal{N}'^k, k \in \mathcal{K}. \quad (5.10)$$

$$\beta_{iw\tau}^k \leq \sum_{\tau=1}^{\min[T, t-p_i^k]} \alpha_{iw\tau}^k, \quad \forall i \in \mathcal{N}'^k, w \in \mathcal{W}^k, k \in \mathcal{K}, t \in \mathcal{T}. \quad (5.11)$$

$$\sum_{\tau=1}^{\min[T, t+p_i^k-1]} \sum_{i \in \mathcal{N}'^k} \alpha_{iw\tau}^k + \sum_{\tau=1}^{\min[T, t+p_{ij}^k-1]} \sum_{(i,j) \in \mathcal{A}'^k} \alpha_{ijw\tau}^k \leq 1 + \sum_{\tau=p_i^k+1}^t \sum_{i \in \mathcal{N}'^k} \beta_{iw\tau}^k + \sum_{\tau=p_{ij}^k+1}^t \sum_{(i,j) \in \mathcal{A}'^k} \beta_{ijw\tau}^k, \quad \forall w \in \mathcal{W}^k, k \in \mathcal{K}, t \in \mathcal{T}. \quad (5.12)$$

The combined objective function balances minimizing cost and disruptive effect while addressing time by using a time index within the two objective functions (5.3). A

general flow balance equation for all nodes is presented in (5.4). Two slack variables are used to capture unmet demand of a specific commodity ($x_{ilt}^{-,k}$) and surplus of a specific commodity ($x_{ilt}^{+,k}$). Flow is restricted based on starting node, ending node, and arc operability as shown in (5.5-5.7), respectively. A damaged node may become operable once repairs are complete (5.8). A damaged node can be repaired only once, as shown in (5.9). Only one work crew can be assigned to repair a node, limiting any compounding positive or negative effect that could be possible with multiple crews being assigned (5.10). A damaged node cannot be completed until it has been assigned and the normal processing time has elapsed (5.11). A work crew can only be assigned to one restoration activity at a given time until the work task is completed (5.12). Equations (5.8-5.11) have corresponding arc-based equivalents not shown above, which substitute the arc indices for the node index.

These flow and scheduling constraints provide the base recovery model similar to other integrated network design and scheduling problems used in infrastructure recovery (González et al. 2016; Nurre et al. 2012; Sharkey et al. 2015). Specifically, Equations (5.4-5.7) were adapted from González et al. (2016) and Equations (5.10-5.12) were inspired by Sharkey et al. (2015). However, both operational and restoration interdependencies must be integrated to address interdependencies.

5.3.4. Integrating operational interdependencies

Operational interdependencies affect the operations of the infrastructure networks by the propagation of failure. The controlling parameter, $\gamma_{i\psi}^{k\bar{k}}$, is a time-indexed parent-child node pairing between infrastructure layers. A new set $\mathcal{N}_{i\psi}^{k\bar{k}}$ is used as a subset of

parent nodes $i \in \mathcal{N}^k$, which have an operational interdependency relationship with a given child node $\tilde{i} \in \mathcal{N}^{\tilde{k}}$ based on some operational interdependency type ψ . This parameter takes on values of 1 or a fractional amount based on the number of parent nodes in the pairing when an operational interdependency exists between the node pairs consisting of parent node(s) $i \in \mathcal{N}^k$ and child node $\tilde{i} \in \mathcal{N}^{\tilde{k}}$. This means if two parent nodes are required for a child node to operate, then the interdependency parameter would be equal to one half.

$$\sum_{i \in \mathcal{N}_{i\psi}^{k\tilde{k}}} \gamma_{i\psi t}^{k\tilde{k}} y_{it}^k \geq y_{\tilde{i}t}^{\tilde{k}}, \quad \forall \tilde{i} \in \mathcal{N}^{\tilde{k}}, \tilde{k} \in \mathcal{K}, \psi \in \Psi, t \in \mathcal{T}. \quad (5.13)$$

$$y_{it}^k b_{ilt}^k \geq b_{ilt}^k + x_{ilt}^{-,k}, \quad \forall i \in \mathcal{N}_D^k, l \in \mathcal{L}^k, k \in \mathcal{K}, t \in \mathcal{T}. \quad (5.14)$$

The operability of a child node depends on the parent node's operability and the operational interdependency relationship parameter, which is shown in (5.13) and adapted from González et al. (2016). For example, in a simple physical interdependent relationship between $i \in \mathcal{N}^k$ and $\tilde{i} \in \mathcal{N}^{\tilde{k}}$, the operational interdependency parameter $\gamma_{i\psi t}^{k\tilde{k}}$ would be equal to 1, and therefore, the child node $\tilde{i} \in \mathcal{N}^{\tilde{k}}$ depends on the operability of the parent node $i \in \mathcal{N}^k$. If the parent node is a demand node, it is essential to ensure that the demand must be met in order for the parent node to be operable, as shown in (5.14).

5.3.5. Integrating restoration interdependencies

Restoration interdependencies include traditional precedence, effectiveness precedence, options precedence, time-sensitive options, and geospatial repair constraints. The first four subtypes exhibit various asset-to-asset relationships as follows: traditional precedence utilizes arc-to-arc relationships, effective precedence utilizes node-to-arc

relationships, options precedence utilizes arc-to-node relationships, and time-sensitive options utilize node-to-node relationships. Each asset-to-asset type of relationship is possible for the first four restoration interdependency subtypes with slight variations to the subsequent constraints. Geospatial repair is handled differently and is addressed following the presentation of the first four restoration interdependency subtypes.

5.3.5.1. Traditional precedence

Traditional precedence is when a parent recovery task at arc $(i, j) \in \mathcal{A}^k$ must be accomplished before a child recovery task at arc $(\tilde{i}, \tilde{j}) \in \mathcal{A}^{\tilde{k}}$ can be started, which is the arc-to-arc or $((i, j), (\tilde{i}, \tilde{j}))$ relationship in the arc-based traditional precedence (*ATP*) set.

$$\sum_{\tau=1}^t \sum_{w \in \mathcal{W}^k} \beta_{ijw\tau}^k \geq \sum_{w \in \mathcal{W}^{\tilde{k}}} \alpha_{\tilde{i}\tilde{j}w}^{\tilde{k}}, \quad \forall ((i, j), (\tilde{i}, \tilde{j})) \in ATP, t \in \mathcal{T}. \quad (5.15)$$

Based on the definition of traditional precedence, the parent arc must be completed ahead of the child arc before the child arc can be started, as shown in (5.15). When the parent asset is a demand node, demand must be met to start the child restoration task and maintain the total demand throughout the restoration activity. While these are not shown due to the arc-to-arc relationship, similar constraints are shown in the effective precedence relationship.

5.3.5.2 Effectiveness precedence

Effective precedence is when a parent recovery task at node $i \in \mathcal{N}^k$ must be accomplished for a child recovery task at arc $(\tilde{i}, \tilde{j}) \in \mathcal{A}^{\tilde{k}}$ to proceed at a normal processing time; however, if the parent node is not completed, then the child recovery task at arc $(\tilde{i}, \tilde{j}) \in \mathcal{A}^{\tilde{k}}$ can still proceed on at an extended processing time. It should be noted that when programming these relationships, it is as if there is a traditional

precedence relationship for the normal processing time and an extended processing time if the traditional precedence conditions are not met.

$$\sum_{\tau=1}^t \sum_{w \in \mathcal{W}^k} \beta_{i w \tau}^k \leq \sum_{\tau=1}^t \sum_{w \in \mathcal{W}^{\tilde{k}}} \alpha_{i j_e w \tau}^{\tilde{k}} + \sum_{\tau=1}^{\min[T, t-p_i^k]} \sum_{w \in \mathcal{W}^k} \alpha_{i w \tau}^k, \quad \forall (i, (\tilde{i}, \tilde{j})) \in NEP, t \in \mathcal{T}. \quad (5.16)$$

$$1 - \frac{x_{i l t}^{-,k}}{-b_{i l t}^k} \geq \sum_{w \in \mathcal{W}^{\tilde{k}}} \alpha_{i j w t}^{\tilde{k}}, \quad \forall (i, (\tilde{i}, \tilde{j})) \in NTP | b_{i l t}^k < 0, l \in \mathcal{L}^k, t \in \mathcal{T}. \quad (5.17)$$

The difference between traditional and effective precedence is the child node's ability to be completed before the parent node, so long as the child task is processed at the extended processing time (5.16). The traditional precedence restriction of meeting demand at the parent node before starting on the child arc is still effective for the assignment variable associated with normal processing time, as shown in (5.17).

Effective precedence relationships adjust several equations already previously presented. The equations that are modified based on the addition of the extended assignment variables are numbered the same as they were previously but are given an asterisk to indicate a slight modification to allow for the extended processing time assignment.

$$\sum_{w \in \mathcal{W}^k} (\alpha_{i w t}^k + \alpha_{i_e w t}^k) \leq 1, \quad \forall i \in \mathcal{N}'^k, k \in \mathcal{K}, t \in \mathcal{T}. \quad (5.10^*)$$

$$\beta_{i w t}^k \leq \sum_{\tau=1}^{\min[T, t-p_i^k]} \alpha_{i w \tau}^k + \sum_{\tau=1}^{\min[T, t-e_i^k]} \alpha_{i_e w \tau}^k, \quad \forall i \in \mathcal{N}'^k, (\tilde{i}, i) \in NEP, ((\tilde{i}, \tilde{j}), i) \in AEP, w \in \mathcal{W}^k, k \in \mathcal{K}, t \in \mathcal{T}. \quad (5.11^*)$$

$$\begin{aligned}
& \sum_{\tau=1}^{\min[T, t+p_i^k-1]} \sum_{i \in \mathcal{N}'^k} \alpha_{i w \tau}^k + \sum_{\tau=1}^{\min[T, t+p_{ij}^k-1]} \sum_{(i,j) \in \mathcal{A}'^k} \alpha_{ij w \tau}^k + \\
& \sum_{\tau=1}^{\min[T, t+e_i^k-1]} \sum_{\left(\begin{array}{l} (i,i) \in NEP, \\ ((i,j), i) \in AEP \end{array} \right)} \alpha_{i_e w \tau}^k + \sum_{\tau=1}^{\min[T, t+e_{ij}^k-1]} \sum_{\left(\begin{array}{l} (i,(i,j)) \in NEP, \\ ((i,j), (i,j)) \in AEP \end{array} \right)} \alpha_{ij_e w \tau}^k \leq 1 + \\
& \sum_{\tau=p_i^k+1}^t \sum_{i \in \mathcal{N}'^k} \beta_{i w \tau}^k + \sum_{\tau=p_{ij}^k+1}^t \sum_{(i,j) \in \mathcal{A}'^k} \beta_{ij w \tau}^k, \quad \forall w \in \mathcal{W}^k, k \in \mathcal{K}, t \in \mathcal{T}. \quad (5.12^*)
\end{aligned}$$

These modified constraints describe how only one work crew can be assigned to repair a node either at a normal or extended processing time (10*). A damaged node cannot be completed until it has been assigned and the normal or extended processing time has elapsed (5.11*). For example, a damaged node $i \in \mathcal{N}'^k$ (e.g., Fire Station) with a normal processing time of two time periods and an extended processing time of three time periods at time period 4 could be repaired (i.e., $\beta_{i w 4}^k = 1$) so long as the repair was assigned in time periods 1 or 2 at a normal processing time or in time period 1 at an extended processing time. A work crew can only be assigned to one restoration activity at a given time until it is completed, regardless of whether the work crew is working at a normal processing time or at an extended processing time (5.12*). Therefore, returning to the Fire Station example, there were three options to assign a work crew in order to make sure the Fire Station was operable by time period 4, but only one of the three options can be picked based on (5.12). Additionally, since the Fire Station was in an effectiveness precedence relationship there is one other task that has to be complete prior to normal processing time, therefore the options are trimmed down to at most two options – normal processing assignment at time period 2 (based on mandatory task for normal processing time equal to one time period) or extended processing time assignment at time period 1. Equations (5.10*) and (5.11*) have corresponding arc-based equivalents.

5.3.5.3. Options precedence

Options precedence is when at least one parent arc must be completed before a child recovery task can begin. This precedence relationship is achieved by summing over the parent-child pairs similar to the traditional precedence, as shown in (5.18). Similar to traditional precedence, node-based relationships must ensure demand is met at parent nodes and remains throughout the child recovery task's duration.

$$\sum_{\tau=1}^t \sum_{w \in \mathcal{W}^k} \sum_{((i,j),\tilde{i}) \in AOP} \beta_{ijw\tau}^k \geq \sum_{w \in \mathcal{W}^{\tilde{k}}} \alpha_{i\tilde{i}w}^{\tilde{k}}, \quad \forall ((i,j),\tilde{i}) \in AOP, t \in \mathcal{T}. \quad (5.18)$$

Mathematically traditional precedence completion (5.15) can be thought of as a special case of options precedence (5.18). However, in describing restoration activities they are used differently. Traditional precedence relationships are often used in a chain of events (e.g., Task A before B, Task B before C, and so on). Options precedence are almost exclusively used as a single event where there are two or more tasks that could satisfy the precedence relationship. Therefore, both restoration interdependencies are used separately.

5.3.5.4. Time-sensitive options

Time-sensitive options are those in which a parent node $i \in \mathcal{N}'^k$ must be operable or child recovery task at node $\tilde{i} \in \mathcal{N}^{\tilde{k}}$ must be accomplished by a certain deadline, $\theta_{i\tilde{i}}^{k\tilde{k}}$.

$$y_{it}^k + \sum_{\tau=1}^{\theta_{i\tilde{i}}^{k\tilde{k}}} \sum_{w \in \mathcal{W}^{\tilde{k}}} \beta_{i\tilde{i}w\tau}^{\tilde{k}} \geq 1, \quad t = \theta_{i\tilde{i}}^{k\tilde{k}}, \dots, T, \quad \forall (i, \tilde{i}) \in NTS. \quad (5.19)$$

$$\sum_{w \in \mathcal{W}^k} \alpha_{i\tilde{i}w}^{\tilde{k}} = 0, \quad t = 1, \dots, \theta_{i\tilde{i}}^{k\tilde{k}} - p_i^{\tilde{k}} - 1, \quad \forall (i, \tilde{i}) \in NTS. \quad (5.20)$$

The child recovery task must be completed by the deadline or the parent node must be operable (5.19). By definition, the child recovery task cannot be assigned until

the normal processing time before the deadline so that one task is completed by the deadline (5.20).

5.3.5.5. Geospatial repair

Nodes and arcs are also geospatially located within at least one space $s \in \mathcal{S}$. Each space is mutually exclusive and comprehensive. This restoration interdependency subtype allows for cost savings during recovery operations by selecting tasks within a geographical region, where recurring costs for mobilization and site preparation can be avoided. This selection process assumes the crews work in a collaborative environment and are managed by a central authority (Lee et al. 2007).

$$\sum_{w \in \mathcal{W}^k} g_{is}^k (\alpha_{iwt}^k + \alpha_{i_{ewt}}^k) \leq z_{st}, \quad \forall i \in \mathcal{N}'^k, s \in \mathcal{S}, k \in \mathcal{K}, t \in \mathcal{T}. \quad (5.21)$$

When a recovery task at node $i \in \mathcal{N}'^k$ is assigned at either a normal or extended processing time, then a variable indicating work in that region is used to indicate some site preparation costs will be necessary (5.21). Equation (5.21) has a corresponding arc equivalent similar to others used in this model. This concludes the abbreviated formulation of the BIIRM.

5.4. Computational Results

This section discusses the infrastructure data used, the unique damage scenario used to showcase operational and restoration interdependencies, and the subsequent analysis of the optimal recovery strategies over a series of scenarios.

5.4.1. Modified CLARC data and damage scenario

A realistic dataset was used based on a modified version of the CLARC County dataset including the social infrastructure systems (Little et al. 2020; Sharkey et al. 2018).

The CLARC dataset represents a county or regional-scale database; however, a municipal

size dataset was desired to parallel the size of a military installation. Therefore, a 10% sampling size was taken based on asset type within the CLARC database while ensuring that at least one of each asset type was represented to preserve the diversity of operations by assets. This resulted in a network approximately the same size and scope as a military installation. This dataset will be referenced as the BIIRM dataset.

The data was then reconfigured into a multiplex construct, a one-to-one mapping of a given node as it is reflected in any layer in which that node functions as a supply, transshipment, or demand node (Bianconi 2018). Each arc is assumed to operate and exist only within a given layer. Reflecting nodes based on demand across multiple layers increased the overall node count (if counting reflected nodes separately) well beyond the original 10% sampling. While the reflection of nodes, increases the number of nodes used for a given instance the multiplex structure is revealing of whether or not operational interdependencies exist. The original CLARC database notes 2,631 instances where one infrastructure depends on another (Sharkey et al. 2018). The construction of the database into a multiplex structure maintained all uni-directional dependencies, but highlighted the 703 interdependencies within that number based on nodes having different functions (i.e., demand, transshipment, supply) within different reflected infrastructure layers. This insight was critical in setting up the interdependency constraints correctly.

Additional significant changes to the dataset included integrating cost information from DoD cost tables (DoD 2020), additional communications infrastructure information to support cyber interdependencies, and addition of another transportation and emergency response commodity of people, which are considered the workforce for the various assets

within the networks. Table 5.2 summarizes the nodes, arcs, and additions made to the dataset.

Table 5.2. The BIIRM dataset with reflected and new nodes and arcs due to increased communication infrastructure data

Infrastructure	<u>10% Sampling</u>		<u>Reflected and New</u>	
	Nodes	Arcs	Nodes	Arcs
Information Communication Technology (ICT)	3	39	100	152
Electrical Power (PWR)	9	116	110	4
Transportation and Emergency Response (TER)	83	366	158	24
Wastewater (WWT)	39	94	62	0
Water (WTR)	19	89	56	0
Subtotals	153	704	486	180
Total Nodes	639		Total Arcs	884

A critical part of the current research is incorporating various types of operational interdependencies simultaneously. The original dataset included only physical and geographic interdependencies; however, with the addition of communication infrastructure and the commodity of people, cyber and logical interdependency types were established. The cyber interdependencies represent infrastructure systems that depend on communication to provide the service from that infrastructure layer (e.g., emergency responders) or systems controlled by Supervisory Control and Data Acquisition (SCADA) systems. The logical interdependencies are based on certain assets or facilities that require workers to be present to provide the infrastructure service from those infrastructure assets (e.g., power plant, water treatment plant). Table 5.3 summarizes the number of operational interdependency subtype relationships across the

associated infrastructure layers. Geographical interdependency relationships were employed during the damage event due to a simulated flood event to specific portions of the network.

Table 5.3. Multiple operational interdependency subtype relationships across all infrastructure systems are incorporated into the BIIRM dataset

Interdependency Subtype	Relationships	Parent Infrastructures	Child Infrastructures
Physical	59	PWR, WTR, WWT	All
Cyber	51	ICT	PWR, TER, WTR, WWT
Logical	13	TER	PWR, TER, WTR, WWT
Geospatial	41	All	All

The damage scenario represents a major flood event, which significantly inundates the lower-lying areas of the network. This causes damage to all different types of networks. The assets damaged include some that have operational and restoration interdependencies and some that do not. Table 5.4 summarizes the damage simulated to nodes and arcs across the five infrastructure layers within the BIIRM dataset.

Table 5.4. Nodes and arcs across all infrastructure systems are damaged in a simulated flood event

Infrastructure	Nodes	Arcs
ICT	9	2
PWR	12	6
TER	5	18
WTR	2	5
WWT	9	5

Based on the damage scenario, several of the recovery tasks exhibit restoration interdependencies or precedence recovery. These recovery tasks range from downed

power lines due to trees that have fallen to pumping flooded streets and refueling generators if necessary. Table 5.5 summarizes the various restoration interdependencies, the coupling method employed in the BIIRM formulation, and a description of the scenarios.

Table 5.5. All infrastructure systems are involved across all five of the restoration interdependency subtypes over 36 restoration activities (approx. 50% of damaged assets)

Type	Parent, Child Infrastructures	Coupling Method	Scenario Description	Number
Traditional Precedence	PWR, TER	arc-to-arc	Power line inspection/de-energize	4
	TER, PWR		Tree removal along power lines	4
Effectiveness Precedence	PWR, TER	node-to-arc	Pumping flooded streets	6
Options Precedence	TER, WTR	arc-to-node	Access to worksite	6
Time-sensitive Options	PWR, ICT	node-to-node	Refueling generators	2
	PWR, WWT		Cleanup due to loss of power	6
Geospatial Repair	All	N/A	N/A	8

5.4.2. Recovery operations landscape

The damage scenario was first analyzed using all nine of the interdependent relationships across varying weights among the two explicit objective functions to provide an overview of the solution landscape. These solutions resulted in a Pareto optimal front which highlighted the intuitive low expenditure yield of minimal operability improvement. The Pareto front also showed the diminishing returns on increased spending over a particular weighted operability. The Pareto front could be used to determine a “sweet spot” for temporary or expedient recovery operations. For example, the initial weighted operability value following disruption was 35,538 and after \$2.6M

the weighted operability value increased to 45,563 which correlates to a 10,025-value increase. However, over the next \$7M the highest increase is only 1,534 which explains diminishing returns. This correlates to infrastructure assets and services that have high cost, but minimal impact to the weighted operability. This understanding can help focus resources to achieve the greatest amount of recovery using temporary and expendable assets. Additionally, some non-essential functions might be able to wait until follow-on efforts are made.

Figure 1 illustrates the balance between cost and operability. The model's input parameters remained constant throughout the evaluated time periods for this scenario (e.g., costs, node-, and arc-priority weights did not fluctuate over time). Although the operability objective and the combined objective values did not increase and decrease monotonically, respectively, when compared to the cost, the overall objective did decrease consistently at every time period, thus illustrating the tradeoff between cost and operability within the overall convex combination.

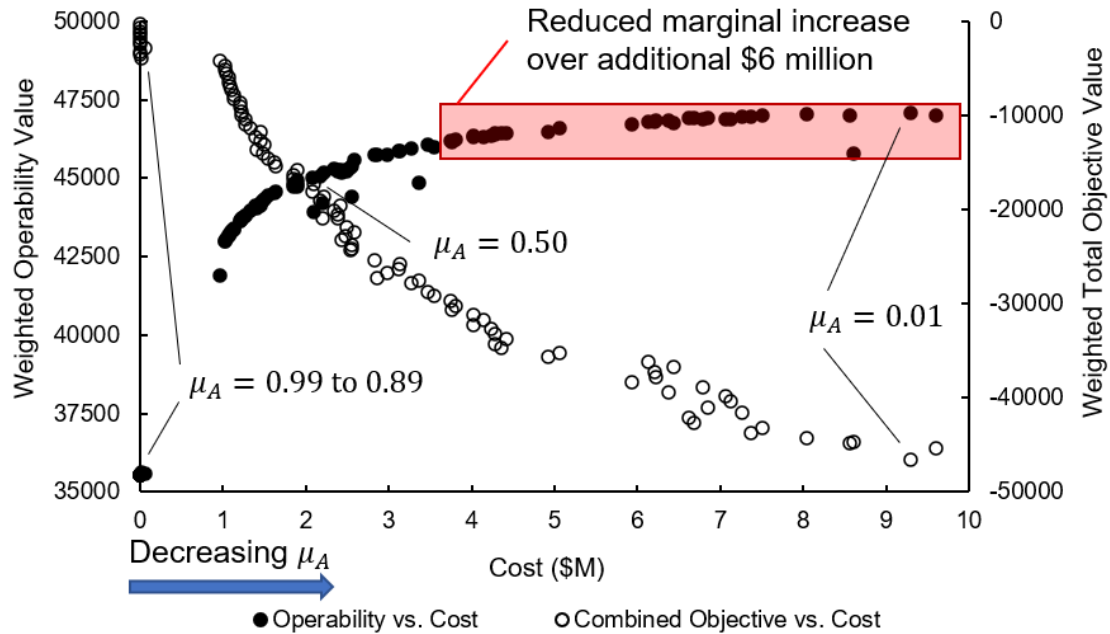

Fig. 1. The convex combination shown as operability vs. cost and the combined objective vs. cost with some μ_A values annotated highlight diminishing returns above a certain operability threshold

5.4.3. Impact of interdependencies

The ability to analyze a recovery scenario with and without interdependencies shows the necessity of acknowledging both operational and restoration interdependencies to create the most accurate site picture. Most current modeling efforts incorporate physical and geospatial operational interdependencies subtypes, if any are included. Therefore, this was used as a base and compared against a simulation that added all the operational interdependency subtypes. These results are tabulated in Table 5.6.

Table 5.6. Exclusion of cyber and logical interdependency subtypes can overestimate operability projections

Operational Interdependency Subtype	Starting Operability (%)	Percent Deviation	Ending Operability (%)	Percent Deviation
Physical & Geospatial	66.1	N/A	92.0	N/A
Physical, Geospatial, Cyber, & Logical	65.9	-0.3	89.9	-2.3

The exclusion of cyber and logical operational interdependency subtypes in this damage scenario meant overestimating the operability shortly after disruption by 0.3%. Whereas by the end of 12 8-hr time periods, the operability was overestimated by 2.3%. While these are the figures for this instance, other scenarios may show greater or lesser disparities depending on the operational interdependency relationships. The ability to include various, multiple, and sometimes compounding interdependent relationships allows for a more accurate estimate of timelines and achievable operability.

A series of simulations were conducted to understand the effect of restoration interdependencies on cost and operability. The simulation that included traditional precedence (TP), effective precedence (EP), options precedence (OP), and time-sensitive options (TS) was assumed to be the closest reflection to reality from the simulations. Multiple simulations were done by removing one or more restoration interdependency subtypes. In terms of cost, the simulation of TP, EP, and OP was the most closely matched simulation of all the others, effectively showing that in this instance, TS did not play a significant role when combined with the other restoration interdependency types. All simulations except TP & EP overestimated the cost initially, which can be understood

as assigning and repairing more work initially that might not be possible due to precedence requirements. This means the model suggested fixing more than can be fixed due to neglecting certain interdependencies. At time period 4, all the simulations except for the one with no restoration interdependencies started to underestimate the cost for the remainder of the recovery efforts, which can be interpreted as giving a low estimate of the actual cost. Only the simulation of no restoration interdependencies consistently overestimated the cost when considered against the assumed picture of reality. Figure 5.2 illustrates the overestimation and underestimation against the simulation with all the restoration interdependency subtypes in terms of cost.

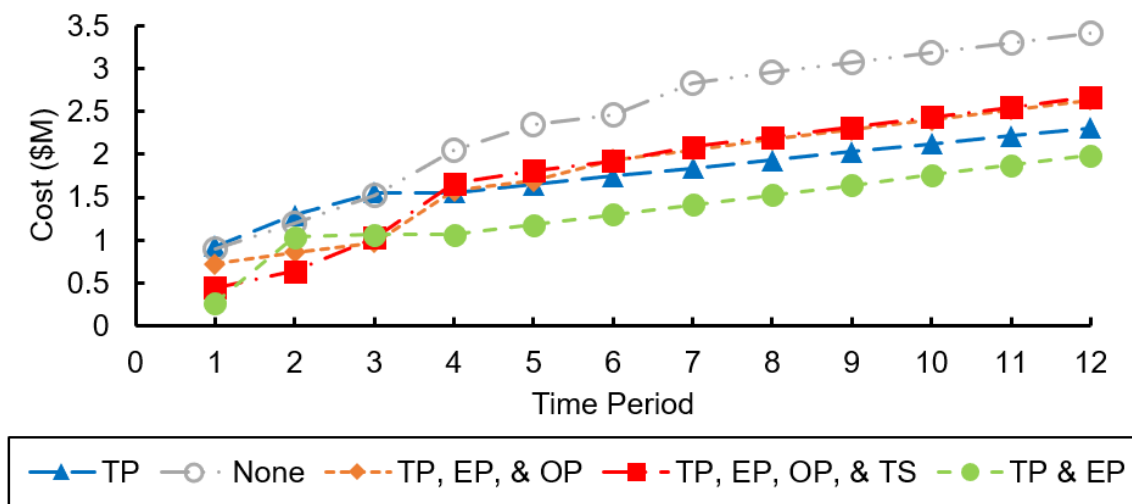

Fig. 5.2. Cost differences based on the restoration interdependencies involved where TP, EP, OP, and TS along with TP, EP, and OP represent the assumed closest to reality

The damage resulted in all the recovery simulations starting with 65.9% of the network operable. The networks were then restored, with every simulation experiencing a significant increase in operability around time period 5 due to a restoration of a critical node. The closest approximation to reality on percent operable is assumed to be the

simulation, including all the restoration interdependency types. In terms of operability, all of the simulations followed the same general trend. The TP & EP simulation improved rapidly along with all others except the TP, EP, OP, & TS simulation and then had no improvement to operability over the later time periods 5 to 12. The TP, EP, OP, & TS simulation lagged behind every other simulation for time periods 1 to 4, but then achieved a greater percent operable than TP-only and TP & EP simulations. The performance of the TP, EP, OP, & TS simulation over the other two seems to indicate that options precedence appreciably affects the system's operability or recovery time in this scenario by creating desirable recovery strategies leading to higher operability. However, the inclusion of time-sensitive options restricted the TP, EP, OP, & TS simulation so it wasn't able to achieve as high operability. In the instance of the simulation with TP, EP, and OP interdependency subtypes and no restoration interdependencies, the percent operable remained consistently over the assumed reality (i.e., TP, EP, OP, & TS simulation). Figure 5.3 illustrates the percent operability throughout recovery operations for the various simulations, with enlarged windows for time periods 1 to 4 and 5 to 12. The TP-only and no restoration interdependencies simulations both experienced a decrease in the operability, which is a manifestation overall objective function balancing cost and disruptive effect as well as Equation (14)'s limitation of operability being based on demand being met. Therefore, in both of these simulations the model restricted flow for one or two time periods causing some assets to be classified as non-operable.

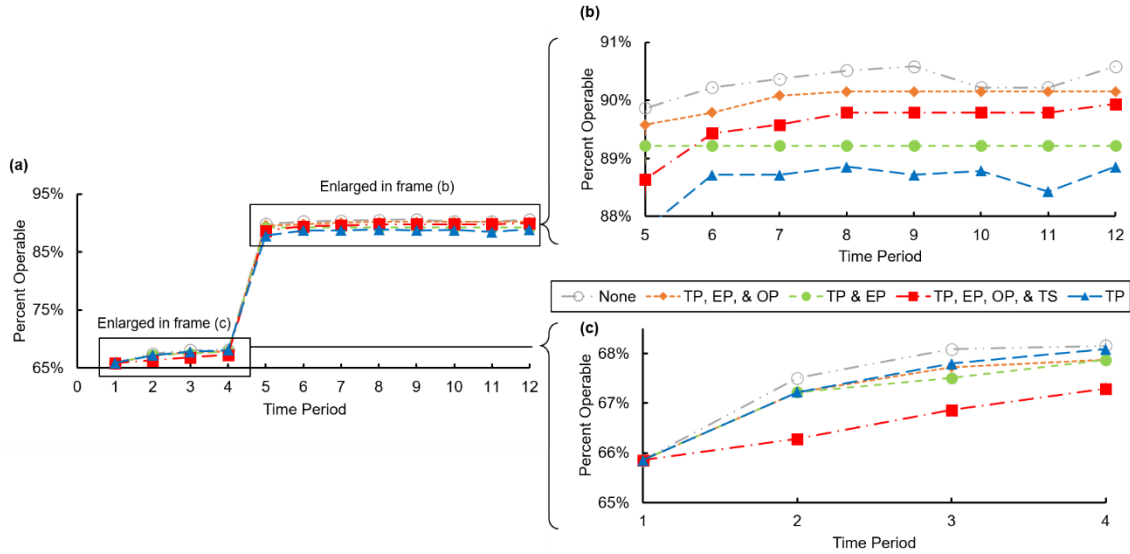

Fig. 5.3. Percent operability of various simulations based on restoration

interdependencies included where the simulation with TP, EP, OP, and TS represents the assumed reality; (a) overview of time periods 1 to 12; (b) enlarged analysis of time periods 5 to 12; (c) enlarged analysis of time periods 1 to 4

In summary, the inclusion and exclusion of restoration interdependency subtypes made the estimations of overall network operability either high or low. In terms of operability, effectiveness precedence and options precedence provide alternate recovery strategies while constraining the solution space resulting in net positive increases. The addition of recovery pathways increases the solution space, while traditional precedence and time-sensitive options restrict possibilities and shrink the solution space.

5.5. Conclusions

Interdependent infrastructure recovery modeling is critical in the complex infrastructure systems used today. The current research seeks to add elements to simultaneously incorporate four different operational interdependency subtypes and five

different restoration interdependency subtypes, which has not been done previously. This effort also adds a military installation-sized dataset, complete with cost data, to the pool of available datasets for interdependent infrastructure restoration modeling and simulation.

The analysis showed that both over and underestimating cost and operability are possible when excluding certain interdependency types. The inclusion of all interdependency types ensures the closest approximation to reality. While the simulated damage event didn't show drastic difference in magnitude for overall deviation based on the inclusion or exclusion of interdependency subtypes, the damage was only 5% of the network, and a larger damage event or an event with a higher rate of interdependencies would likely make the magnitude of inaccurate recovery prediction significantly larger.

The primary concern with future efforts includes providing a way to address non-binary operability among nodes and arcs. The use of binary operability is common in infrastructure recovery modeling; however, binary operability is not always a good representation of reality. The restriction to binary operability is a shortcoming of the current model and other models similar in construction. Additionally, even though most of the parameters are indexed on time, they are bound by linear relationships within a given time period, thus they can only approximate complex, non-linear relationships such as multi-input cost structures. Expansion of work done by others to integrate resource competition is similarly warranted, since resource limitations are likely to cause problems with recovery as damage events grow in size. Finally, the interdependencies examined were illustrated only between infrastructure pairs, and an expansion of this to include greater complexity in the number of infrastructure layers could be explored.

VI. The Flexible Team Base Interdependent Infrastructure Recovery Model (tmBIIRM)¹

6.1. Introduction

Civil infrastructure systems are complex (Lewe et al. 2014), interdependent (Rinaldi et al. 2001), and critical to national security (Department of Homeland Security 2013). The critical nature of infrastructure systems to national security is recognized by nations around the world (Hall et al. 2016). In the United States, the link between security and critical civil infrastructure had a prominent place embedded in the first pillar of the 2017 National Security Strategy. In part, this strategy stated, “We must build a culture of preparedness and resilience among our government functions, critical infrastructure, and economic and political systems” (United States 2017). This strategy detailed additional priorities to ensure resilient infrastructure.

Resilient infrastructure is a necessity in today’s interconnected world. A recent example is the Colonial Pipeline cyberattack, which resulted in gas distribution shutdown, subsequent gas price increases, fuel shortages in certain areas in eastern portions of the United States, and a \$4M ransom to the attacker (Turton and Mehrotra 2021). Due to a cyberattack in the control system, multiple other systems were impacted including oil and gas distribution systems, transportation infrastructure, commercial infrastructure, and social infrastructures. A disruption in one system caused some level of disruptions across multiple other systems, signifying the interdependent nature of

¹ The contents of this chapter are anticipated to be submitted for publication by Moore, Schuldt, Grandhi, and Jacques to the *Military Operations Research* Journal late 2021. The article is tentatively titled “Flexible Recovery Team Management on Simulated Interdependent Civil Infrastructure Systems.”

infrastructure systems. These systems did not respond as well as desired and therefore the infrastructure system-of-systems lacked desirable resilient characteristics.

Resilient infrastructures are sometimes defined as 1) those infrastructure systems capable of coping and bouncing back from unanticipated disruptions and 2) those infrastructure systems which are able to maintain structure during external stresses (Attoh-Okine 2016). In terms of defense-focused definitions, military installation resilience is defined as the ability “to avoid, prepare for, minimize the effect of, adapt to, and recover from” intentional or unintentional and anticipated or unanticipated effects of disruptions in order to “maintain, improve, or rapidly reestablish ...mission-essential functions” (Legal Information Institute 2021). These definitions essentially capture both the vulnerability and recoverability sides of resilience in critical infrastructure and are essential to the present research (Almoghathawi et al. 2017).

This research seeks to address the resilience of critical infrastructure systems in a socio-technical framework examining interdependent infrastructure recovery (IIR) of a simulated disrupted military installation. Many IIR models assume certain characteristics about recovery personnel and recovery teams. These assumptions can be vulnerabilities if not properly addressed. This work seeks to analyze the effect of the education, training, and skill of recovery personnel in the context of IIR efforts. A novel mixed-integer non-linear programming (MINLP) model is presented as a way to evaluate the contribution recovery personnel make to the resilience of military installations. The MINLP requires network, personnel, and damage data inputs in order to establish optimal recovery team composition, work schedules, and least-cost recovery strategies (i.e., identification and

order of assets to recover). A series of discrete disruptive events are simulated to show the importance of recovery personnel in recovery operations.

The remainder of this article establishes relevant IIR literature with an emphasis on how recovery personnel or recovery teams are modeled. Then the MINLP is presented followed by a description of the damage scenarios. Results of the model are discussed and conclusions are drawn regarding the importance of considering personnel contributions to the recoverability or resilience of interdependent infrastructure systems.

6.2. Literature Review

This research focused on network flow-based IIR modeling and examines the assumptions surrounding modeling recovery personnel's impact on system recovery. The assumptions can be divided into four broad categories. These categories are team composition, team management, resource management, and work conditions. These assumptions were often made to reduce modeling complexity or were a subjective assessment of the circumstances being modeled.

Team composition comprises the aspects of how the work crews are formed or defined. IIR team composition modeling includes no team or ambiguous team structure, parallel team structure, and parallel teams matched to given infrastructure systems. Certain authors suggested that workers were necessary, but did not suggest any sort of team composition structure (González et al. 2016; Lee et al. 2007). The lack of consideration for team composition suggests that how repair crews were pre-defined or that team organization was not relevant to that modeling effort.

Nurre et al. (2012), building from general Scheduling Theory, defined the work crews as parallel teams similar to parallel machines in processing applications. The

authors used two to three teams in total to evaluate the various network disruptions with the associated datasets. Cavdaroglu et al. (2013), building off the work of Lee et al. (2007) in terms of model formulation and notation, identified three parallel work crews for the simulations they were conducting, whereas Lee et al. did not identify any specific crews. These assumptions implicitly make teams of equal size and equally capable to repair damaged assets.

Sharkey et al. (2015) added an element of skill matching to team composition, ensuring work crews were associated with a given infrastructure system. An example of this skill matching is ensuring electricians work on downed power lines and water utility personnel work on a broken water main. This practice has been used by others as a way to ensure that team composition and skill matching is considered at least in a rudimentary fashion (Almoghathawi et al. 2019). This rudimentary skill matching makes the assumption that work in one infrastructure will not require work skills from another infrastructure system.

None of these team composition strategies (i.e., no stated structure/ambiguous team structure, non-specific parallel teams, and infrastructure-specific teams) are sufficient to deliver tailored recovery operations and address specific military requirements. Current military practice aligns with current research in disaster recovery, requiring multi-disciplinary teams for assessment and repair (Cavallo and Ireland 2014; Lahiri et al. 2021). Additionally, the U.S. Air Force desires to improve training and education to cultivate multi-skilled personnel (Roberson and Stafford 2017). Improvements can be made to team composition in order to incorporate personnel

knowledge, skill, and abilities and by allowing flexible teaming structures in varying sizes to meet the recovery operations' specific needs.

Team management comprises the assumptions about how repair crews can be utilized to recover disrupted systems. Every set of authors reviewed in this research who addressed this concept incorporated the concept of a single team assignment within a non-preemptive environment (Almoghathawi et al. 2019; Cavdaroglu et al. 2013; Nurre et al. 2012; Sharkey et al. 2015). This largely meant only one work crew could work on a recovery task at a time and that once a task was started the work crew would remain on that task until it was complete. The requirement to remain on a task implies all damage is known at the time of decision and nothing more important will come up. The requirement for only one work crew per task precludes massing or teaming up on priority tasks.

An example of the single assignment within a non-preemptive environment restriction is when Work Crew A finishes Priority 1 Task they cannot go and assist the recovery of Priority 2 Task which is being worked by Work Crew B. If Work Crew A were allowed to assist Work Crew B, then Priority 2 Task could be accomplished sooner. Rather Work Crew A must be reassigned to a lower priority task due to this restriction. While these scenarios might have potential application, experience and common sense dictate that flexibility in team management and the ability to put more personnel on a given task when determined effective should be possible.

Resource management addresses the assumption that each team has sufficient resources to accomplish all repair tasks. One of the few authors to address this made a general constraint suggesting that in order to repair a given asset some resources were required (González et al. 2016). This generalization allowed the same constraint to

encompass a high-value, low-quantity material used in recovery, a piece of equipment, or even a work crew. It was a unique formulation but at least some mention of resource management was incorporated.

One resource not appraised at all in the IIR models reviewed is experience, though it is consistently ranked as one of the most important elements in construction labor productivity (Ahmed et al. 2020; Alwasel et al. 2017; Johari and Jha 2020; Khanh et al. 2021; Liberda et al. 2003; Pathirage et al. 2005; Rojas and Aramvareekul 2003). For example, masonry workers' experience level resulted in a range of 0.67 to 1.8 blocks per minute, which is nearly a three-fold increase in productivity based on experience (Alwasel et al. 2017). Another study on masonry productivity rates based on experience level showed a range of 0.6 to 2.2 as a multiplier based on a number of circumstances (Khanh et al. 2021). This somewhat intangible resource is underexplored as a factor in IIR modeling.

Work conditions addresses the assumptions regarding the circumstances, effectiveness, or success of the work. Assumptions surrounding work conditions tend to stem from the previous assumptions highlighted and include no effect of productivity rate due to workers' knowledge, skills, and abilities and the unstated assumption that all repairs will be on-time and effective. Sharkey et al. (2015) addressed the first issue in a very specific way by identifying a restoration interdependency called effectiveness precedence. This relationship meant that unless a given task was accomplished the other task would require additional time. An example is trying to clear standing water from a flooded street. If power is restored to a nearby lift station, then the work will proceed at a

normal speed. If power is not restored to the lift station, then pump trucks will continue to be used and the time to clear the flooded street will be prolonged.

The only author to address on-time and successful repairs from the reviewed literature was González (2017) in his dissertation work on modeling interdependent infrastructure networks. He employed stochastic optimization and conditional probability in order to address uncertainty in repair success. While this specific challenge to work conditions did not directly relate to work crews it was insightful as a way to incorporate varying work conditions.

In summary, assumptions associated with team composition, team management, resource management, and work conditions have the potential to impact the recoverability of infrastructure systems. The recoverability of infrastructure systems then impacts the resilience of systems. Specifically, relaxing the prevailing assumptions of rigid parallel teams, the non-preemptive environment, not considering knowledge, skill, and abilities of recovery personnel, and not allowing multiple crews to work on recovery tasks will result in more realistic models for recovery operations within the military.

The remainder of this article presents a novel MINLP to address these characteristics of recovery operations. The presentation of the model is followed by a description of the damage scenario, followed by the results and discussion of the analysis.

6.3. Methodology

The purpose of this section is to present the MINLP that first seeks to balance multi-commodity flow within a disrupted network while simultaneously scheduling repairs. Second the model then integrates both operational and restoration interdependencies identified and presented in Moore et al. (2021). The output of the

model is 1) a least-cost recovery strategy, 2) work crew assignments for each time period, and 3) recovery progress on all damaged assets for each time period.

The unique MINLP presented in this work is denoted as the flexible team base interdependent infrastructure recovery model (tmBIIRM). Most of the previous models reviewed were mixed-integer linear programs (MIP) and solved to optimality by using solvers (i.e., CPLEX), which employs linear relaxation of the integer problem and dual feasibility to prove optimality (IBM Corp. 2017). Some authors chose to employ heuristics to improve computational time to include iterations in lieu of time indices (González et al. 2016) and dispatching rules (Nurre et al. 2012). The non-linear nature of the present work, precludes the use of the CPLEX solver but leverages a non-linear solver BARON, which employs a branch and reduce algorithm to navigate the integer program.

6.3.1. Combined network flow and scheduling repairs

Consistent with other models, the base model seeks to balance network flow and scheduling repairs within the disrupted network (Nurre et al. 2012; Sharkey et al. 2015). The infrastructure systems are modeled using a multilayered network consisting of nodes and arcs which represent the built assets within the infrastructure layers. Multicommodity flow is used to represent the infrastructure services that are necessary to support military operations to be conducted within the network. An example of an infrastructure service that is required to perform a military operation is fire and emergency services which are necessary for crash rescue of aircraft experiencing an in-flight emergency. The ability to meet the demand of the fire and emergency services at the node representing the airfield implies the infrastructure is capable of supporting the military operations in this instance.

If the delivery of fire and emergency services is prohibited as commodity flow based on damaged intermittent nodes or arcs, then that infrastructure must be repaired before that infrastructure service is available for the designated military operation.

Scheduling repairs is multifaceted. A brief description of scheduling repairs might entail: identify infrastructure damage, assign repair crews, and repair the damage. This simple description of scheduling repairs bypasses the formation and management of the actual repair crew or assumes it is pre-defined and appropriate for the damage. The current research includes team composition and skill-matching as part of the scheduling process and therefore the brief description of scheduling repairs becomes: identify infrastructure damage, assign and match personnel to repair crews, assign and match repair crews to damaged infrastructure, and repair the damage. This intentionally adds in the element of work crew composition and skill-matching for the completion of the recovery tasks. These steps are often assumed away, but are part of the necessary process to successfully repair damaged infrastructure systems.

Table 6.1 identifies sets, parameters, and variables associated with the network flow and the infrastructure system's operability. It is assumed that commodities flowing within a given network share the overall arc capacity within that given network. An example is recovery crews, essential personnel, fire trucks, police, and ambulance all share the same capacity limitations of the damaged transportation infrastructure layer.

Table 6.1. Sets, parameters, and variables associated with network flow and network operations

Notation	Description
\mathcal{A}	Set of arcs, indexed as (i, j) .
\mathcal{A}^k	Subset of arcs within a given infrastructure layer $k \in \mathcal{K}$.
\mathcal{A}'	Set of damaged arcs.
\mathcal{A}'^k	Subset of damaged arcs within a given layer $k \in \mathcal{K}$.
\mathcal{L}	Set of commodities.
\mathcal{L}^k	Subset of commodities able to flow within a given layer $k \in \mathcal{K}$.
\mathcal{N}	Set of nodes, indexed as i .
\mathcal{N}^k	Subset of nodes within a given infrastructure layer $k \in \mathcal{K}$. A further subset can be designated using a subscript to denote demand (D), supply (S), and transshipment (T) nodes.
\mathcal{N}'	Set of all damaged nodes.
\mathcal{N}'^k	Subset of damaged nodes within a given layer $k \in \mathcal{K}$.
b_{ilt}^k	Supply or demand of commodity $l \in \mathcal{L}^k$ at node $i \in \mathcal{N}^k$ at time period $t \in \mathcal{T}$.
c_{ijlt}^k	Cost of flowing commodity $l \in \mathcal{L}^k$ through arc $(i, j) \in \mathcal{A}^k$ at time period $t \in \mathcal{T}$.
u_{ijt}^k	Capacity parameter of arc $(i, j) \in \mathcal{A}^k$ shared by all commodities flowing along that arc at time period $t \in \mathcal{T}$.
μ_{ijt}^k or μ_{it}^k	Weighting parameter for arc $(i, j) \in \mathcal{A}'^k$ or node $i \in \mathcal{N}'^k$ indicating the assigned value for that asset to be operable at time period $t \in \mathcal{T}$.
μ_A or μ_B	Weighting parameter for cost objective and operability objective.
x_{ijlt}^k	Variable representing flow of commodity $l \in \mathcal{L}^k$ along arc $(i, j) \in \mathcal{A}^k$ at time period $t \in \mathcal{T}$.
$x_{ilt}^{-,k}$	Slack variable representing unmet demand of commodity $l \in \mathcal{L}^k$ at node $i \in \mathcal{N}^k$ at time period $t \in \mathcal{T}$.
$x_{ilt}^{+,k}$	Slack variable representing surplus of commodity $l \in \mathcal{L}^k$ at node $i \in \mathcal{N}^k$ at time period $t \in \mathcal{T}$.
y_{ijt}^k or y_{it}^k	Binary variable indicating if arc $(i, j) \in \mathcal{A}^k$ or node $i \in \mathcal{N}^k$ is operable at time period $t \in \mathcal{T}$.

Table 6.2 identifies sets, parameters, and variables associated with the scheduling and repair of infrastructure systems. It is assumed that damaged nodes and arcs are initially inoperable and that damaged assets only become operable after they are fully repaired. In reality, some partial operability might be possible if the damage is minor enough; however, this operability assumption is consistent with other modeling efforts (Almoghathawi et al. 2019; González et al. 2016; Lee et al. 2007; Sharkey et al. 2015). The repairs are assumed to be temporary fixes in order to restore infrastructure services.

Temporary repairs are those repairs which restore the infrastructure services, but sometimes do not completely achieve pre-disruption capabilities or performance. For example, a blown transformer can be bypassed in order to restore power back to a critical facility, and then the transformer can be repaired at a later time.

Table 6.2. Sets, parameters, and variables associated with scheduling workers and repairing infrastructure systems

Notation	Description
\mathcal{F}	Set of knowledge, skills, and abilities that are required for restoration tasks, indexed as $f = \{1, \dots, F\}$.
\mathcal{S}	Set of locations.
\mathcal{W}	Set of all work crews, indexed as $w = \{1, \dots, W\}$, where $W \leq P/2$ since all work crews must have at least two people in them
Π	Set of workers or personnel that can be assigned to a work crew, indexed as $\pi = \{1, \dots, P\}$.
$\alpha_{\pi t}$	Hourly cost rate parameter of assigning personnel $\pi \in \Pi$ during time period $t \in \mathcal{T}$.
$E_{\pi f}$	Parameter indicating the experience level of personnel $\pi \in \Pi$ based on the skill set $f \in \mathcal{F}$.
g_{st}	Cost parameter of geospatial site preparation of space $s \in \mathcal{S}$ started at time period $t \in \mathcal{T}$.
p_{if}^k or p_{ijf}^k	Parameter indicating normal processing time in manhours for repair of node $i \in \mathcal{N}^k$ or arc $(i, j) \in \mathcal{A}^k$ requiring skill set $f \in \mathcal{F}$.
q_{ijt}^k or q_{it}^k	Cost parameter of repair for recovery task at arc $(i, j) \in \mathcal{A}^k$ or node $i \in \mathcal{N}^k$ at time period $t \in \mathcal{T}$.
ϕ_i^k or ϕ_{ij}^k	Number of skill sets associated with the restoration activity at node $i \in \mathcal{N}^k$ or arc $(i, j) \in \mathcal{A}^k$.
Ω	Parameter designating the number of hours in a time period (e.g., 8-hour work shifts, 12-hour half-day shifts, etc.)
g_{ijs}^k or g_{is}^k	Binary variable indicating if arc $(i, j) \in \mathcal{A}^k$ or node $i \in \mathcal{N}^k$ is in space $s \in \mathcal{S}$.
z_{st}	Binary variable indicating if a recovery task in space $s \in \mathcal{S}$ is assigned during time period $t \in \mathcal{T}$.
$Z_{\pi wt}$	Binary variable that is equal to 1 if personnel $\pi \in \Pi$ is assigned to work crew $w \in \mathcal{W}$ in time period $t \in \mathcal{T}$.
α_{ijwt}^k or α_{iwt}^k	Variable indicating the number of manhours work crew $w \in \mathcal{W}$ is assigned to a recovery task at arc $(i, j) \in \mathcal{A}^k$ or node $i \in \mathcal{N}^k$ during time period $t \in \mathcal{T}$.
β_{ijt}^k or β_{it}^k	Binary variable equal to 1 if recovery task at arc $(i, j) \in \mathcal{A}^k$ has been completed by the end of time period $t \in \mathcal{T}$ and 0 otherwise
Δ_{ift}^k or Δ_{ijft}^k	Variable amount of work completed on restoration activity requiring skill set $f \in \mathcal{F}$ by the end of time period $t \in \mathcal{T}$.
$\eta_{\pi ft}$	Variable indicating what percentage of time personnel $\pi \in \Pi$ is engaged in repair work utilizing skill set $f \in \mathcal{F}$ within time period $t \in \mathcal{T}$.
Θ_{ift}^k or Θ_{ijft}^k	Variable amount representing the effective time at a restoration activity requiring skill set $f \in \mathcal{F}$ by the end of time period $t \in \mathcal{T}$.

The MINLP has two primary objectives associated with cost and operability. The cost objective seeks to minimize multiple costs associated with different aspects of recovery operations. There are four different costs to include site preparation, worker assignment, repair, and flow costs. These are summed in the cost objective shown in (6.1).

$$\text{Cost Objective: } A = \sum_{t \in \mathcal{T}} \left(\sum_{s \in \mathcal{S}} g_{st} z_{st} + \sum_{w \in \mathcal{W}} \sum_{\pi \in \Pi} a_{\pi t} \Omega Z_{\pi w t} + \sum_{k \in \mathcal{K}} \left(\sum_{(i,j) \in \mathcal{A}^k} q_{ijt}^k \beta_{ijt}^k + \sum_{i \in \mathcal{N}^k} q_{it}^k \beta_{it}^k + \sum_{l \in \mathcal{L}^k} \sum_{(i,j) \in \mathcal{A}^k} c_{ijlt}^k x_{ijlt}^k \right) \right). \quad (6.1)$$

The first term in (6.1) represents the site preparation costs. Site preparation costs represent the costs associated with mobilization, detour planning and routing if necessary, and excavation to reach buried utilities. There is one cost per area and is an average case cost based on the type of terrain (i.e., urban, suburban, trees, open). The second term is the assignment cost and is calculated based on the hourly labor rate for a given personnel multiplied by the man-hours in the time period multiplied by a variable indicating assignment to a work crew. The third and fourth terms are the repair costs based on completed work on damaged arcs and nodes, respectively. The fifth cost is the cost to flow commodities through the network. Each of these terms are indexed by time so as to handle fluctuating costs which are often experienced during recovery operations as scarce commodities drive costs (Sharkey et al. 2016).

The operability objective seeks to maximize the operability of nodes and arcs. Operability is used instead of unmet demand in order to give critical linear assets, which are represented by arcs, a chance to have equal weight as any given node. This choice emphasizes critical linear assets to achieve military objectives to include airfield

pavements, communication lines, and critical power lines. The operability objective is shown in (6.2).

$$\text{Disruption Objective: } B = \sum_{t \in \mathcal{T}} \sum_{k \in \mathcal{K}} (\sum_{i \in \mathcal{N}^k} \mu_{it}^k y_{it}^k + \sum_{(i,j) \in \mathcal{A}^k} \mu_{ijt}^k y_{ijt}^k). \quad (6.2)$$

The first term is the weighted nodal operability and the second term is arc-based operability. The priority weighting terms are also indexed by time, which allows stakeholders to assign time-dependent values which can be an important element in examining infrastructure resilience (Poulin and Kane 2021).

These two objectives are combined in a weighted summation using the negative of the operability function to result in an overall minimization problem. This is shown in (6.3), following which, several network flow and scheduling constraints are presented and then explained. A suffix ‘‘arc’’ is attached to some of the equation numbers in this section to denote an arc-based version of the same constraint.

$$\text{Minimize } \mu_A A - \mu_B B. \quad (6.3)$$

Subject to the following constraints

$$\sum_{j:(i,j) \in \mathcal{A}^k} x_{ijlt}^k - \sum_{j:(j,i) \in \mathcal{A}^k} x_{jilt}^k = b_{ilt}^k + x_{ilt}^{-,k} - x_{ilt}^{+,k}, \quad \forall i \in \mathcal{N}^k, l \in \mathcal{L}^k, k \in \mathcal{K}, t \in \mathcal{T}. \quad (6.4)$$

$$\sum_{l \in \mathcal{L}^k} x_{ijlt}^k \leq u_{ijt}^k y_{it}^k, \quad \forall (i,j) \in \mathcal{A}^k, i \in \mathcal{N}^k, k \in \mathcal{K}, t \in \mathcal{T}. \quad (6.5)$$

$$\sum_{l \in \mathcal{L}^k} x_{ijlt}^k \leq u_{ijt}^k y_{jt}^k, \quad \forall (i,j) \in \mathcal{A}^k, j \in \mathcal{N}^k, k \in \mathcal{K}, t \in \mathcal{T}. \quad (6.6)$$

$$\sum_{l \in \mathcal{L}^k} x_{ijlt}^k \leq u_{ijt}^k y_{ijt}^k, \quad \forall (i,j) \in \mathcal{A}^k, k \in \mathcal{K}, t \in \mathcal{T}. \quad (6.7)$$

$$y_{it}^k \leq \sum_{\tau=1}^t \beta_{i\tau}^k, \quad \forall i \in \mathcal{N}^k, k \in \mathcal{K}, t \in \mathcal{T}. \quad (6.8)$$

$$y_{ijt}^k \leq \sum_{\tau=1}^t \beta_{ij\tau}^k, \quad \forall (i,j) \in \mathcal{A}^k, k \in \mathcal{K}, t \in \mathcal{T}. \quad (6.8.\text{arc})$$

$$\beta_{it}^k \leq \frac{\sum_{f \in \mathcal{F}} \Delta_{ift}^k}{\phi_i^k}, \quad \forall i \in \mathcal{N}'^k, k \in \mathcal{K}, t \in \mathcal{T}. \quad (6.9)$$

$$\beta_{ijt}^k \leq \frac{\sum_{f \in \mathcal{F}} \Delta_{ijft}^k}{\phi_{ij}^k}, \quad \forall (i, j) \in \mathcal{A}'^k, k \in \mathcal{K}, t \in \mathcal{T}. \quad (6.9.arc)$$

$$\Delta_{ift}^k = \frac{\Theta_{ift}^k}{p_{if}^k}, \quad \forall i \in \mathcal{N}'^k, k \in \mathcal{K}, f \in \mathcal{F}, t \in \mathcal{T}. \quad (6.10)$$

$$\Delta_{ijft}^k = \frac{\Theta_{ijft}^k}{p_{ijf}^k}, \quad \forall (i, j) \in \mathcal{A}'^k, k \in \mathcal{K}, f \in \mathcal{F}, t \in \mathcal{T}. \quad (6.10.arc)$$

$$\Theta_{ift}^k = \sum_{w \in \mathcal{W}} \sum_{\pi \in \Pi} \eta_{\pi ft} E_{\pi f} Z_{\pi wt} \alpha_{iwt}^k, \quad \forall i \in \mathcal{N}'^k, k \in \mathcal{K}, f \in \mathcal{F}, t \in \mathcal{T}. \quad (6.11)$$

$$\Theta_{ijft}^k = \sum_{w \in \mathcal{W}} \sum_{\pi \in \Pi} \eta_{\pi ft} E_{\pi f} Z_{\pi wt} \alpha_{ijwt}^k, \quad \forall (i, j) \in \mathcal{A}'^k, k \in \mathcal{K}, f \in \mathcal{F}, t \in \mathcal{T}. \quad (6.11.arc)$$

$$\sum_{f \in \mathcal{F}} \eta_{\pi ft} \leq 1, \quad \forall \pi \in \Pi, t \in \mathcal{T}. \quad (6.12)$$

$$\sum_{w \in \mathcal{W}} Z_{\pi wt} = 1, \quad \forall \pi \in \Pi, t \in \mathcal{T}. \quad (6.13)$$

$$\sum_{\pi \in \Pi} Z_{\pi wt} \geq 2, \quad \forall w \in \mathcal{W}, t \in \mathcal{T}. \quad (6.14)$$

$$\sum_{i \in \mathcal{N}'^k} \alpha_{iwt}^k + \sum_{(i,j) \in \mathcal{A}'^k} \alpha_{ijwt}^k \leq \Omega, \quad \forall w \in \mathcal{W}, t \in \mathcal{T}. \quad (6.15)$$

$$x_{ijlt}^k \geq 0, \quad \forall (i, j) \in \mathcal{A}^k, l \in \mathcal{L}^k, k \in \mathcal{K}, t \in \mathcal{T}. \quad (6.16)$$

$$x_{ilt}^{-,k} \geq 0, \quad \forall i \in \mathcal{N}^k, l \in \mathcal{L}^k, k \in \mathcal{K}, t \in \mathcal{T}. \quad (6.17)$$

$$x_{ilt}^{+,k} \geq 0, \quad \forall i \in \mathcal{N}^k, l \in \mathcal{L}^k, k \in \mathcal{K}, t \in \mathcal{T}. \quad (6.18)$$

$$y_{it}^k \in \{0,1\}, \quad \forall i \in \mathcal{N}^k, k \in \mathcal{K}, t \in \mathcal{T}. \quad (6.19)$$

$$y_{ijt}^k \in \{0,1\}, \quad \forall (i, j) \in \mathcal{A}^k, k \in \mathcal{K}, t \in \mathcal{T}. \quad (6.19.arc)$$

$$Z_{\pi wt} \in \{0,1\}, \quad \forall \pi \in \Pi, w \in \mathcal{W}, t \in \mathcal{T}. \quad (6.20)$$

$$0 \leq \alpha_{iwt}^k \leq \Omega, \quad \forall i \in \mathcal{N}'^k, w \in \mathcal{W}, k \in \mathcal{K}, t \in \mathcal{T}. \quad (6.21)$$

$$0 \leq \alpha_{ijwt}^k \leq \Omega, \quad \forall (i, j) \in \mathcal{A}'^k, w \in \mathcal{W}, k \in \mathcal{K}, t \in \mathcal{T}. \quad (6.21.arc)$$

$$\beta_{it}^k \in \{0,1\}, \forall i \in \mathcal{N}'^k, k \in \mathcal{K}, t \in \mathcal{T}. \quad (6.22)$$

$$\beta_{ijt}^k \in \{0,1\}, \forall (i,j) \in \mathcal{A}'^k, k \in \mathcal{K}, t \in \mathcal{T}. \quad (6.22.arc)$$

$$0 \leq \Delta_{ift}^k \leq 1, \forall i \in \mathcal{N}'^k, k \in \mathcal{K}, t \in \mathcal{T}. \quad (6.23)$$

$$0 \leq \Delta_{ijft}^k \leq 1, \forall (i,j) \in \mathcal{A}'^k, k \in \mathcal{K}, t \in \mathcal{T}. \quad (6.23.arc)$$

$$0 \leq \eta_{\pi ft} \leq 1, \forall \pi \in \Pi, f \in \mathcal{F}, t \in \mathcal{T}. \quad (6.24)$$

$$0 \leq \Theta_{ift}^k \leq p_{if}^k, \forall i \in \mathcal{N}'^k, k \in \mathcal{K}, f \in \mathcal{F}, t \in \mathcal{T}. \quad (6.25)$$

$$0 \leq \Theta_{ijft}^k \leq p_{ijf}^k, \forall (i,j) \in \mathcal{A}'^k, k \in \mathcal{K}, f \in \mathcal{F}, t \in \mathcal{T}. \quad (6.25.arc)$$

The general flow balance equation is shown in (6.4), where outflow minus inflow is equal to supply or demand plus any unmet demand and minus any surplus. The term b_{it}^k is used for both supply and demand, such that when $b_{it}^k < 0$ the node is a demand node, when $b_{it}^k = 0$ the node is a transshipment node, and when $b_{it}^k > 0$ the node is a supply node. Only demand nodes can have a non-zero positive slack variable indicating unmet demand, $x_{it}^{-,k}$. Only supply nodes can have a non-zero positive slack variable indicating surplus supply, $x_{it}^{+,k}$. The addition of slack variables is essential in a network flow scenario where the nodes and arcs can be damaged and unable to be used in order to flow commodities. Flow is restricted in (6.5) to (6.7) based on the arc capacity and operability of the starting node, ending node, and arc, respectively. These general flow equations follow the initial flow modeling of González et al. (2016).

The next constraints describe the restoration activities and the requirements to restore a damaged asset. A damaged node and arc must be completely repaired in order for it to become operable as seen in (6.8) and (6.8.arc), respectively. A node and arc are completely restored when all the work requiring various skills are complete as shown in

(6.9) and (6.9.arc), respectively. These last constraints incorporate skill matching. For example, a node requiring electrical, HVAC, and structural work in order to be completed has the variables Δ_{ift}^k indicating the decimal percent of work accomplished at the given node $i \in \mathcal{N}^k$ requiring skills $f \in \{electrical, HVAC, structural\}$ would need to sum to 3, representing that the work associated with each of the necessary skills is complete. The number would then be divided by the number of skills required for that job in order to be complete. The completion status of a given node or arc based on certain skill $f \in \mathcal{F}$ are calculated in (6.10) and (6.10.arc), respectively.

The next set of constraints to be described are focused on the scheduling decisions made during recovery operations. The effective man-hours applied toward completing a task depends on the amount of time a person is using a certain skill, at a certain proficiency, while working on a specific work crew for a given number of hours as seen in (6.11) and (6.11.arc) for nodes and arcs, respectively. This is the only non-linear constraint within the model and is what makes the overall model a MINLP instead of a MIP. These constraints integrate the concepts of team composition and skill-matching and are essential to this formulation.

A worker is capable of using only one skill at a time during a given time period as seen in (6.12). A worker can be assigned to only one work crew within a given time period, but they are able to be on different work crews across the several time periods within the evaluation window as show in (6.13). An employee safety mandate was used to ensure work crews consisted of at least two people, which can be eliminated as a constraint if not applicable. Likewise an upper bound can be imposed on this same constraint to restrict team sizes to manageable numbers, which was not done in this

current effort. The minimum crew size restriction is seen in (6.14) and also sets a default upper limit for the number of work crews as being half of the worker population, though it can be restricted further. The final scheduling constraint ensures that work crews are not assigned to work more than the number of man-hours available in a given time period. For this formulation all the time periods were kept the same length, but, if necessary, the Ω -term could be indexed by t , which would allow for varying lengths of time periods. This might be appropriate if smaller time frames are deemed critical for the first 24 to 48 hours, and then the recovery operations will be looked at in larger time frames.

The last constraints, namely (6.16) to (6.25) are side constraints. These constraints explain the nature of the variables and also express some upper and lower bounds when appropriate. These objectives and constraints form the basis of the model and capture the network flow and scheduling restrictions. The next subsection will detail how operational and restoration interdependencies are integrated into the MINLP.

6.3.2. Integrating operational and restoration interdependencies

Interdependencies are largely in two forms, operational – affecting the operations of the system, and restoration-based – affecting the order and precedence in which recovery operations are conducted. Rinaldi et al. (2001) provided a set of four operational interdependencies, which are used in the present work. Sharkey et al. (2015, 2016) identified five restoration interdependencies, of which four precedence-focused interdependencies are used in the present work. Finally, González et al. (2016) introduced a final restoration interdependency and illustrated how operational interdependencies can be coupled, which work was elaborated upon by others (Moore et al. 2021a).

This subsection presents the constraints associated with various interdependency subtypes followed by brief descriptions of the constraints. Table 6.3 identifies sets, parameters, and variables associated with interdependencies.

Table 6.3. Sets, parameters, and variables associated with operational and restoration interdependencies

Notation	Description
ATP and NTP	Sets representing arc-based traditional precedence and node-based traditional precedence.
AEP and NEP	Sets representing arc-based effectiveness precedence and node-based effectiveness precedence.
AOP and NOP	Sets representing arc-based options precedence and node-based options precedence.
ATS and NTS	Sets representing arc-based time-sensitive options and node-based time-sensitive options.
$\mathcal{N}_{i\psi\xi}^{k\bar{k}}$	Set of nodes in infrastructure layer $k \in \mathcal{K}$ that have a parent-child interdependent relationship with child node $\bar{i} \in \mathcal{N}^{\bar{k}}$ based on some operational interdependency subtype $\psi \in \Psi$ and some coupling strategy $\xi \in \Xi$.
Ξ	Set of coupling strategies, indexed as ξ .
Ψ	Set of operational interdependency subtypes, indexed as ψ .
e_{if}^k or e_{ijf}^k	Parameter representing the extended processing time in man-hours for repair of arc $(i, j) \in \mathcal{A}^k$ requiring skill $f \in \mathcal{F}$.
$\gamma_{i\psi\bar{i}\bar{j}}^{k\bar{k}}$	Operational interdependency parameter based on parent-child node pairs $i \in \mathcal{N}_{i\psi\xi}^{k\bar{k}}$ with some operational interdependency type $\psi \in \Psi$.
$\theta_{i\bar{i}}^{k\bar{k}}, \theta_{i\bar{j}}^{k\bar{k}}, \theta_{i\bar{j}\bar{i}}^{k\bar{k}}$, and $\theta_{i\bar{j}\bar{j}}^{k\bar{k}}$	Parameters indicating the deadline for time-sensitive options to start if parent assets are restored for node-to-node, node-to-arc, arc-to-node, and arc-to-arc, respectively.
$\alpha_{ije\bar{w}t}^k$ or $\alpha_{ie\bar{w}t}^k$	Variable indicating the number of extended processing time manhours work crew $w \in \mathcal{W}$ is assigned to a recovery task at arc $(i, j) \in \mathcal{A}^k$ or node $i \in \mathcal{N}^k$ with extended processing time during time period $t \in \mathcal{T}$.
θ_{ieft}^k or θ_{ijeft}^k	Variable indicating the effective man-hours processed against the extended processing time, which were accomplished at node $i \in \mathcal{N}^k$ or arc $(i, j) \in \mathcal{A}^k$ requiring skill $f \in \mathcal{F}$ at time period $t \in \mathcal{T}$.

Operational interdependencies can be illustrated as node-to-node parent-child relationships. The behavior of the relationship depends on the coupling $\xi \in \Xi$, which for this model are defined as one-to-one, one-to-any, and one-to-all. Not included in this model is a one-to-many coupling strategy, since it is inconsistent with a binary operability variable (Moore et al. 2021a). Table 6.4 establishes the various values the

operational interdependency parameter $\gamma_{i\bar{i}\psi\xi t}^{k\bar{k}}$ takes based on the coupling. The presence of the ψ index within the interdependency parameter allows for layered operational interdependencies of differing subtypes (i.e., physical, logical, cyber, geospatial). An example is a wastewater treatment plant requiring the raw wastewater, power, water, and personnel to run the plant. The raw wastewater is handled within the wastewater infrastructure layer as a single commodity flow problem, where a disruption in the system would result in a treatment plant not servicing the total system demand. The power and water represent physical interdependencies between the power and water infrastructure layers and the wastewater infrastructure layer. The dependence on workers to run the treatment plant is a logical interdependency and if workers are unable to arrive at the plant, eventually there will be some lapse in service or a degradation of service. Since the interdependency parameter is also indexed on time, the interdependency may be temporary or experience a lag in the effects on the system of interest.

Table 6.4. Effect of coupling strategy $\xi \in \Xi$ on operational interdependency parameter

$\gamma_{i\bar{i}\psi\xi t}^{k\bar{k}}$ given some sort of node-to-node parent-child relationship

Coupling, ξ	Description	$\gamma_{i\bar{i}\psi\xi t}^{k\bar{k}}$
One-to-one	$\bar{i} \in \mathcal{N}^{\bar{k}}$ is only functional when a specific singular node $i \in \mathcal{N}_{i\psi\xi}^{k\bar{k}}$ is functional.	1
One-to-any	$\bar{i} \in \mathcal{N}^{\bar{k}}$ is functional when at least one node of a subset is functional, namely some node $i \in \mathcal{N}_{i\psi\xi}^{k\bar{k}}$.	1
One-to-all	$\bar{i} \in \mathcal{N}^{\bar{k}}$ is functional only if every node from a subset $\mathcal{N}_{i\psi\xi}^{k\bar{k}}$ is functional.	$\frac{1}{ \mathcal{N}_{i\psi\xi}^{k\bar{k}} }$

The following two constraints concisely summarize how operational interdependencies are incorporated within this model. The first constraint shown in (6.26) is modified from González et al. (2016) by adding interdependency subtype, coupling, and time indices and controlling the summation over a specialized set of nodes that have a pairing based on specific interdependent relationships and coupling strategies.

$$\sum_{i \in \mathcal{N}_{i\psi\xi}^{k\tilde{k}}} \gamma_{i\psi\xi t}^{k\tilde{k}} y_{it}^k \geq y_{it}^{\tilde{k}}, \quad \forall \tilde{i} \in \mathcal{N}^{\tilde{k}}, \tilde{k} \in \mathcal{K}, \psi \in \Psi, \xi \in \Xi, t \in \mathcal{T}. \quad (6.26)$$

$$y_{it}^k b_{ilt}^k \geq b_{ilt}^k + x_{ilt}^{-,k}, \quad \forall i \in \mathcal{N}_D^k, l \in \mathcal{L}^k, k \in \mathcal{K}, t \in \mathcal{T}. \quad (6.27)$$

The operability of a child node within an operational interdependent relationship depends on the operability of the parent node and numeric value assigned to the interdependency parameter as shown in (6.26). A general constraint is also included to repress operability if demand is not met as shown in (6.27). This last constraint makes the assumption that operability is contingent upon infrastructure services.

The remainder of this subsection describes how the various restoration interdependencies are incorporated into the model. All of the precedence constraints exhibit distinct parent-child relationships with distinct asset-to-asset coupling which can be described as node-to-node (n2n), node-to-arc (n2a), arc-to-node (a2n), or arc-to-arc (a2a). For brevity of presentation only node-to-node relationships are shown with the other relationships presented in Appendix E. Suffixes are added to designate the unique coupling being described on appropriate constraints.

The first four restoration interdependency subtypes are built following the logic of Sharkey et al. (2015) and are also called precedence constraints. The first restoration interdependency subtype is called traditional precedence. Traditional precedence is when

a recovery task in the parent infrastructure must be accomplished prior to starting any work on a recovery task in the child infrastructure. An example is downed trees that need to be cleared prior to repairing an overhead electrical distribution line.

$$\sum_{\tau=1}^t \beta_{it}^k \geq \frac{1}{\Omega} \sum_{w \in \mathcal{W}} a_{iwt}^{\bar{k}}, \quad \forall (i, \tilde{i}) \in NTP, t \in \mathcal{T}. \quad (6.28.n2n)$$

$$\Omega y_{it}^k \geq a_{iwt}^{\bar{k}}, \quad \forall (i, \tilde{i}) \in NTP, w \in \mathcal{W}, t \in \mathcal{T}. \quad (6.29.n2n)$$

Equation (6.28) ensures that the parent asset is complete, prior to any work on a child asset. There is an additional constraint which ensures that for node-based traditional precedence the parent node is not only repaired but is also operable, to include meeting demand throughout the repair of the child node as shown in (6.29).

The second restoration interdependency subtype is effective precedence. Effective precedence uses the same traditional precedence relationship for normal completion time, but also allows for extended processing time of a recovery task if repair of the parent node is not completed first. An example of this is clearing a flooded street of excess water, which either requires restoring power to a combined storm water and wastewater pump for normal completion time or requires a pump truck at a longer or extended processing time. This type of precedence adds variables associated with assigning work crews to tasks at an extended processing time. This extended processing time is only an option for assets with an effectiveness precedence relationship. The addition of new variables requires the modification to previously presented constraints, which retain their original purpose and are shown in (6.10*), (6.11*), and (6.15*). An asterisk is used with the previous numbering in order to designate a change to a previously presented constraint.

$$\Delta_{ift}^k = \frac{\Theta_{ift}^k}{p_{if}^k} + \frac{\Theta_{ieft}^k}{e_{if}^k}, \quad \forall i \in \mathcal{N}'^k, (\tilde{i}, i) \in NEP, ((\tilde{i}, \tilde{j}), i) \in AEP, k \in \mathcal{K}, f \in \mathcal{F}, t \in$$

$$\mathcal{T}. \quad (6.10^*)$$

$$\Delta_{ijft}^k = \frac{\Theta_{ijft}^k}{p_{ijf}^k} + \frac{\Theta_{ijeft}^k}{e_{ijf}^k}, \quad \forall (i, j) \in \mathcal{A}'^k, (\tilde{i}, (i, j)) \in NEP, ((\tilde{i}, \tilde{j}), (i, j)) \in AEP, k \in$$

$$\mathcal{K}, f \in \mathcal{F}, t \in \mathcal{T}. \quad (6.10^*.arc)$$

$$\Theta_{ieft}^k = \sum_{w \in \mathcal{W}} \sum_{\pi \in \Pi} \eta_{\pi ft} E_{\pi f} Z_{\pi wt} \alpha_{i_{ewt}}^k, \quad \forall (\tilde{i}, i) \in NEP, ((\tilde{i}, \tilde{j}), i) \in AEP, f \in$$

$$\mathcal{F}, t \in \mathcal{T}. \quad (6.11^*)$$

$$\Theta_{ijeft}^k = \sum_{w \in \mathcal{W}} \sum_{\pi \in \Pi} \eta_{\pi ft} E_{\pi f} Z_{\pi wt} \alpha_{i_{j_{ewt}}}^k, \quad \forall (\tilde{i}, (i, j)) \in NEP, ((\tilde{i}, \tilde{j}), (i, j)) \in$$

$$AEP, f \in \mathcal{F}, t \in \mathcal{T}. \quad (6.11^*.arc)$$

$$\sum_{i \in \mathcal{N}'^k} \alpha_{iwt}^k + \sum_{(i,j) \in \mathcal{A}'^k} \alpha_{ijwt}^k + \sum_{\left(\begin{array}{l} (\tilde{i}, i) \in NEP, \\ ((\tilde{i}, \tilde{j}), i) \in AEP \end{array} \right)} \alpha_{i_{ewt}}^k +$$

$$\sum_{\left(\begin{array}{l} (\tilde{i}, (i, j)) \in NEP, \\ ((\tilde{i}, \tilde{j}), (i, j)) \in AEP \end{array} \right)} \alpha_{i_{j_{ewt}}}^k \leq \Omega, \quad \forall w \in \mathcal{W}, k \in \mathcal{K}, t \in \mathcal{T}. \quad (6.15^*)$$

$$\sum_{\tau=1}^t \beta_{it}^k \leq \sum_{\tau=1}^t \sum_{w \in \mathcal{W}} \alpha_{i_{ew\tau}}^{\tilde{k}} + \sum_{\tau=1}^{\min[T, \Omega t - p_{if}^k]} \sum_{w \in \mathcal{W}} \alpha_{iwt}^k, \quad \forall (i, \tilde{i}) \in NEP, f \in$$

$$\mathcal{F}, t \in \mathcal{T}. \quad (6.30.n2n)$$

$$\Omega y_{it}^k \geq \alpha_{iwt}^{\tilde{k}}, \quad \forall (i, \tilde{i}) \in NEP, w \in \mathcal{W}, t \in \mathcal{T}. \quad (6.31.n2n)$$

The main difference in the effectiveness precedence and traditional precedence is seen in the option to start work at an extended processing time without the parent asset being restored or allowing for proper normal processing time before the parent asset would be complete as shown in (6.30). Similar to traditional precedence, if recovery of the child asset is scheduled at normal recovery time, then the parent node must be operable as shown in (6.31).

The third restoration interdependency subtype is options precedence. This can be thought of as a child recovery task requiring completion of at least one of the parent recovery tasks. Options precedence can be considered as multiple parents to a singular child in an asset-to-asset relationship. Traditional precedence is more than just a special case of options precedence in that traditional precedence relationships are often built into chains of events, where options precedence are single decision-point events. An example of options precedence is restoring power to the hospital by repairing a downed power line or by equipping the facility with a mobile generator for critical loads.

$$\sum_{\tau=1}^t \sum_{(i,\tilde{i}) \in NOP} \beta_{i\tau}^k \geq \frac{1}{\Omega} \sum_{w \in \mathcal{W}} \alpha_{iwt}^{\tilde{k}}, \quad \forall (i, \tilde{i}) \in NOP, t \in \mathcal{T}. \quad (6.32.n2n)$$

$$\Omega y_{it}^k \geq \alpha_{iwt}^{\tilde{k}}, \quad \forall (i, \tilde{i}) \in NOP, w \in \mathcal{W}, t \in \mathcal{T}. \quad (6.33.n2n)$$

One of two or more parent assets must be repaired prior to work starting on a child recovery task as shown in (6.32). Parent nodes must be operable to include having demand met, in order to work on the child recovery task as seen in (6.33).

The fourth restoration interdependency subtype is time-sensitive options. Time-sensitive options describe those instances when a recovery task must be accomplished by a certain deadline or another recovery task will be generated. An example is power needs to be restored to a cell tower before the fuel in the generator hits a critical level at a specific time. If power is not restored by the deadline, then a crew needs to be dispatched to refuel the generator.

$$y_{it}^k + \sum_{\tau=\theta_{ii}^{k\tilde{k}}}^t (\sum_{w \in \mathcal{W}} \alpha_{iwt}^{\tilde{k}} + \beta_{i\tau}^{\tilde{k}}) \geq 1, \quad t = \theta_{ii}^{k\tilde{k}}, \dots, T, \quad \forall (i, \tilde{i}) \in NTS. \quad (6.34.n2n)$$

$$\sum_{w \in \mathcal{W}} \alpha_{iwt}^{\tilde{k}} = 0, \quad t = 1, \dots, \theta_{ii}^{k\tilde{k}} - 1, \quad \forall (i, \tilde{i}) \in NTS. \quad (6.35.n2n)$$

At the time of the deadline, the parent asset must be operational or the newly generated recovery task must be started. Beyond the initial deadline the parent asset must be operable or the child recovery task must be actively being worked on or be completed as seen in (6.34). In order to simulate the recovery task being generated at the deadline, the child recovery task is not allowed to be worked on until just before the deadline as shown in (6.35).

The fifth and final restoration interdependency subtype is geospatial repair. Geospatial repair includes work to prepare a site (e.g., mobilization, site safety, detours, notification, utility excavation) and represents the average work necessary for a given location based on terrain type. An example demonstrating potential cost savings is scheduling road repair and a water main repair which share one geospatial location to be performed at the same specific time period, thereby only incurring the site preparation fees once as shown in (6.36). The node- and arc-based constraints (6.36) are based on the logic used by González et al. (2016). The side constraint governing the work location variable is shown in (6.37).

$$\frac{1}{\Omega} \sum_{w \in \mathcal{W}} g_{is}^k (\alpha_{iwt}^k + \alpha_{i_{e}wt}^k) \leq z_{st}, \quad \forall i \in \mathcal{N}'^k, s \in \mathcal{S}, k \in \mathcal{K}, t \in \mathcal{T}. \quad (6.36)$$

$$\frac{1}{\Omega} \sum_{w \in \mathcal{W}} g_{ijs}^k (\alpha_{ijwt}^k + \alpha_{ij_{e}wt}^k) \leq z_{st}, \quad \forall (i, j) \in \mathcal{A}'^k, s \in \mathcal{S}, k \in \mathcal{K}, t \in \mathcal{T}. \quad (6.36.arc)$$

$$z_{st} \in \{0,1\}, \quad \forall s \in \mathcal{S}, t \in \mathcal{T}. \quad (6.37)$$

Additionally, side constraints are added to define the extended processing time variables of $\alpha_{i_{e}wt}^k$, $\alpha_{ij_{e}wt}^k$, $\Theta_{i_{e}ft}^k$, and $\Theta_{ij_{e}ft}^k$ similarly as they were defined for normal processing time. These side constraints are implemented in the model but not shown.

This concludes the formulation of the tmBIIRM and the following section discusses the damage scenarios and results.

6.4. Computational Results

This section discusses 1) the simulated military network and damage scenarios, 2) the integration of personnel data, and 3) the results of analysis. Each of these points are discussed in the following subsections.

6.4.1. The simulated interdependent infrastructure military network

This subsection discusses the simulated military network and damage scenarios. The simulated interdependent civil infrastructure networks were built based on a model constructed by Valencia (2013) for risk analysis. The infrastructure networks were constructed in a multiplex format which means there is a one-for-one mapping of nodes across layers. Nodes are reflected when it operates as a demand node, supply node, or transshipment node within the reflected network. An example of this is a water distribution pump residing in the water infrastructure layer that also has an electrical power demand. Therefore, the water pump is reflected in the power infrastructure layer. A total of five infrastructure layers were used comprising telecommunications, power, transportation, water, and wastewater.

Within the network two different scenarios were simulated using a minimum and maximum extent of damage. A flattened representation of the network is shown in Figure 6.1 where the simulated damage is also identified. The military context is based on a critical mission being conducted out of Admin Facility 1, which is the primary target of a kinetic attack using an improvised explosive device causing an explosion. The explosion is combined with simultaneous cyber-attacks to key industrial control systems. The

overall initial targeted attacks disrupt the infrastructure services and creates a state in which repair crews must repair the network to continue to conduct military operations.

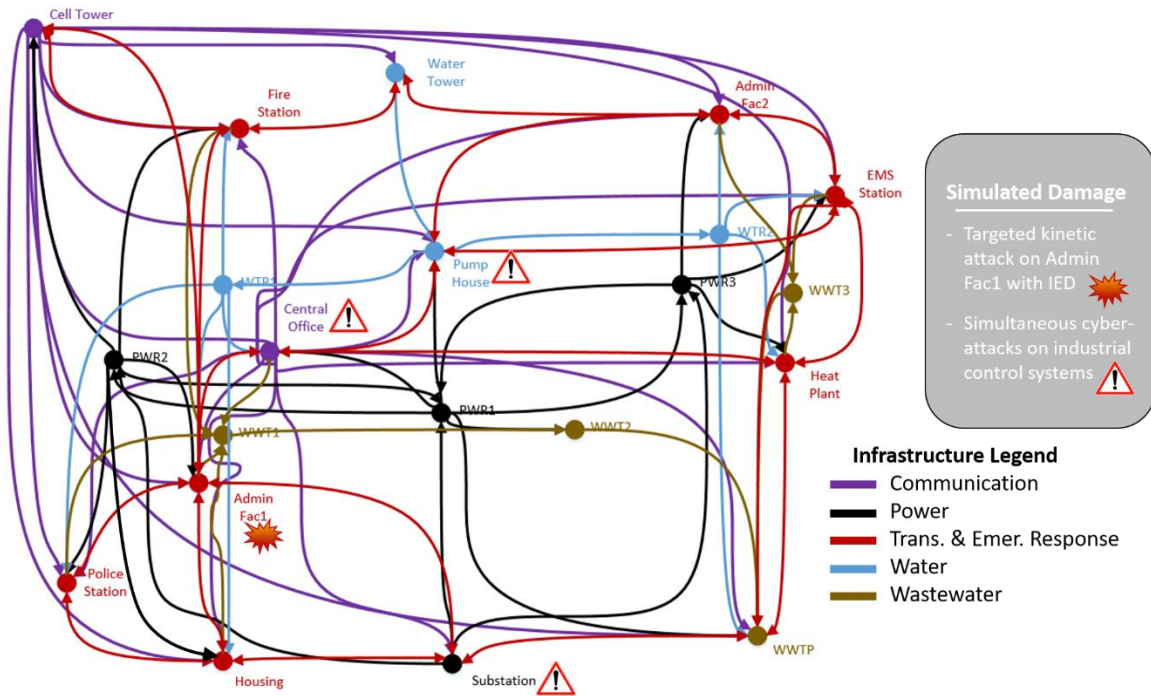

Fig. 6.1. Flattened representation of the simulated military network and targeted disruptions with both kinetic and cyber-attacks

In the damage scenarios, the most extensive damage is to the critical facilities and support infrastructure in close proximity of the kinetic attacks. Table 6.5 summarizes the network and damage scenario characteristics.

Table 6.5. Network and damage scenario characteristics within simulated network

Asset	Quantity	Assets Damaged	Percent Damaged
Node	67*	7	10.4%
Arc	105	10	9.5%

* 21 Nodes and 46 nodal reflections

An important element of interdependent infrastructure recovery are the interdependencies. The simulated military network exhibits multiple operational and restoration interdependencies, which are not dominated by one system only, but rather follows network-to-network interdependencies used in other public access datasets such as the CLARC dataset (Little et al. 2020; Loggins and Wallace 2015; Sharkey et al. 2018). Table 6.6 summarizes the number and type of interdependencies within the system.

Table 6.6. Number and type of interdependency relationships within the network

Operational	Qty.	Parent-Child Infra.*	Restoration	Qty.	Parent-Child Infra.*
Physical	7	PWR-ICT	Traditional precedence	1	PWR-WTR
		PWR-WTR			
		PWR-WWT	Effectiveness precedence	2	WTR-WTR WTR-WWT
		WTR-TER			
		WTR-WWT			
Cyber	5	ICT-PWR	Options precedence	6	TER-PWR
		ICT-TER			
Logical	5	TER-TER	Time-sensitive options	2	PWR-PWR
		TER-WWT			
		WTR-TER			
Geospatial	1	WWT-WTR	Geospatial repair	3	Any-Any

* ICT – telecommunications, PWR – power, TER – transportation, WTR – water, WWT - wastewater

The combination of the networks with interdependencies and a military-focused context creates a small simulated set of civil infrastructure networks for use to show the veracity of challenging the prevailing teaming assumptions. Personnel information such

as skill and experience had to be included into the dataset and is discussed in the following subsection.

6.4.2. Integration of skilled labor data

A representative U.S. Air Force Civil Engineer personnel dataset used in other simulation and planning scenarios was obtained and used. No personal identifiable information accompanied the dataset. Each individual represented some type of craftsman with associated skill sets. Table 6.7 lists the craftsmen and then lists the primary skills associated with that craft. Some craftsmen have secondary or tertiary skills, and all laborers have an unlisted skill called “general” – meaning general labor.

Table 6.7. Worker crafts and associated primary, secondary, and tertiary skills

Worker Craft	Primary	Secondary	Tertiary
Cable & Antenna Systems	Communications	Structures	
Electrical Systems	Electrical	Generator	
Engineering & Surveyors	Surveying		
Heating, Ventilation, Air Conditioning, & Refrigeration	HVAC	Plumbing	Electrical
Pavement & Construction Equipment	Pavements	Structures	Surveying
Power Production	Generator	Electrical	
Structural	Structures	Pavements	Surveying
Water and Fuel Systems Maintenance	Plumbing	Structures	

A skill level is also associated with each individual for any skill listed in Table 6.7. It was assumed that secondary and tertiary skill proficiency were less than the level attained within the primary skill. Additionally, the U.S. Air Force Civil Engineer community uses a tiered skill level system of apprentice, journeyman, craftsman, and superintendent. The first three skill levels are the most important in this research and

roughly equate to the efficiency which is expected from an individual worker. This means that an apprentice will take a little longer to accomplish the same task that a journeyman could accomplish, while the craftsman will finish the same task faster than the journeyman. These ideas contributed to the information embodied in $E_{\pi f}$ – the experience parameter.

6.4.3. The effect of flexible team management on infrastructure recovery

This subsection details the results of analyzing the effect of teams throughout the damage events. The tmBIIRM was programmed using GAMS v31.1.1 on a desktop computer with an Intel Xeon CPU-E5-1620 processor operating at 3.60 GHz with 16 GB of RAM. The solver used was BARON v20.4.14. All tests were conducted using ten 8-hour time periods with 25 work crew personnel. The average run time was 48 minutes. Due to the nature of military operations, the operability objective was more heavily weighted, i.e., $\mu_B = 0.8$, in most of the analysis. Additionally, in order to achieve a balance of computational time and accuracy, a relative optimality gap of lower than 5% was allowed as a solver stopping criterion.

A comparative analysis was conducted using the flexible team MINLP denoted as tmBIIRM and a parallel team MIP based on the authors' previous work (Moore et al. 2021b) denoted as BIIRM. The same damage scenarios were used with both models. For comparison's sake six work crews were simulated, effectively adding an upper bound to Equation (6.14). The tmBIIRM allowed varying team compositions from time period to time period while the BIIRM simulated team assignment in a infrastructure-specific parallel assignment fashion. This allowed for better evaluation of including flexible team composition and skill matching to levels of damage caused to nodes and arcs.

The max extent of the damage in these scenarios yielded repair times approximately three times greater than the min damage scenarios. Figure 6.2 shows a comparison of the system operability based on the use of the flexible teaming model (tmBIIRM) or the parallel team model (BIIRM) and damage level.

The tmBIIRM showed extremely quick recovery capability with the min damage, while the max damage showed both greater and lesser overall system operability levels. In total, both the min and max tmBIIRM scenarios did not recover as many of the network assets, leaving some network assets in a disrupted state. Both models chose not to repair some of the wastewater infrastructure. This is due to the model's tradeoff of cost to gain in weighted system operability. To change this outcome a modeler or infrastructure stakeholder could adjust the nodal weight for a given system, which in these scenarios weighted electrical systems the most important and wastewater some of the least important. Of the 175 assets, the tmBIIRM did not repair 6 and 9 assets for the min and max damage events, respectively. The BIIRM did not repair 5 assets for both min and max damage events.

A general trend in the comparison of the flexible teaming and parallel teaming models is the more abrupt nature of the parallel teaming model output. The flexible teaming model output is more gradual, though it also has large increases at time periods 2 and 5 for the max damage event.

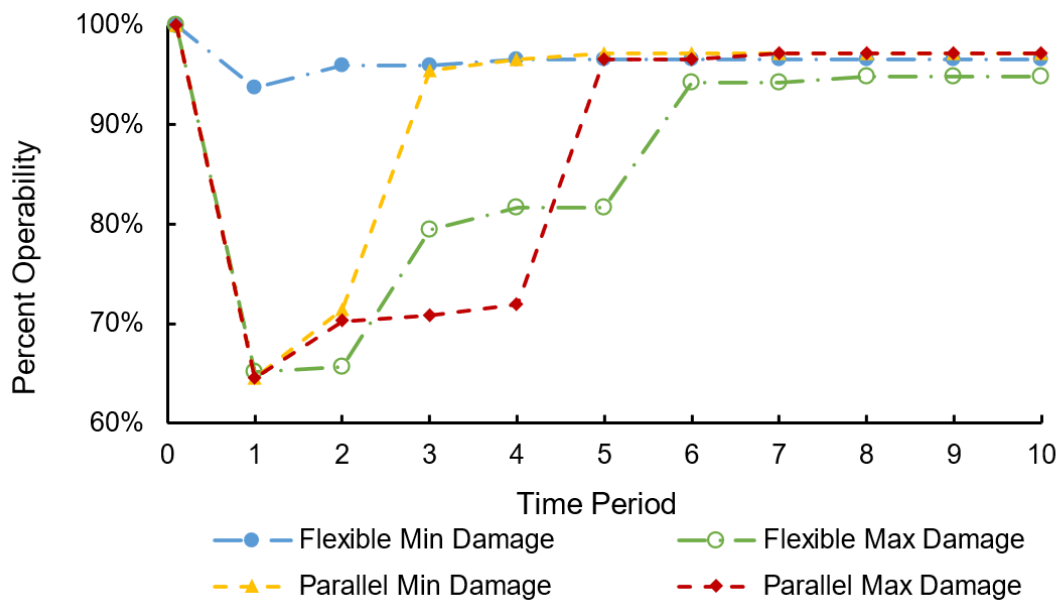

Fig. 6.2. Comparison of flexible teaming and parallel teaming infrastructure recovery based on a min and max level of damage evaluated within the same damage scenario

Figure 6.3 shows the worker skill usage by craft. Based on the given damage scenario the electrical, plumbing, and structures craft were most heavily used in their primary skill, with HVAC not significantly less. Communications and generator laborers were largely used for their secondary skills. Pavements showed the highest idle time, meaning they were employed at a work site for a portion of the time, but then had nothing more to contribute before the work day was complete. General labor was mixed in among all the crafts with two notable exceptions: one electrician and one surveyor were used only as general laborers. This is a complete deviation from the parallel teams assumption, since it was just assumed that either the crews had all necessary skills or the skill set was only associated with a given infrastructure layer. Therefore, in contrast to the variety of

skills used for optimal recovery incorporating flexible teams as seen in Figure 6.3. each employee would be used only in the primary skill.

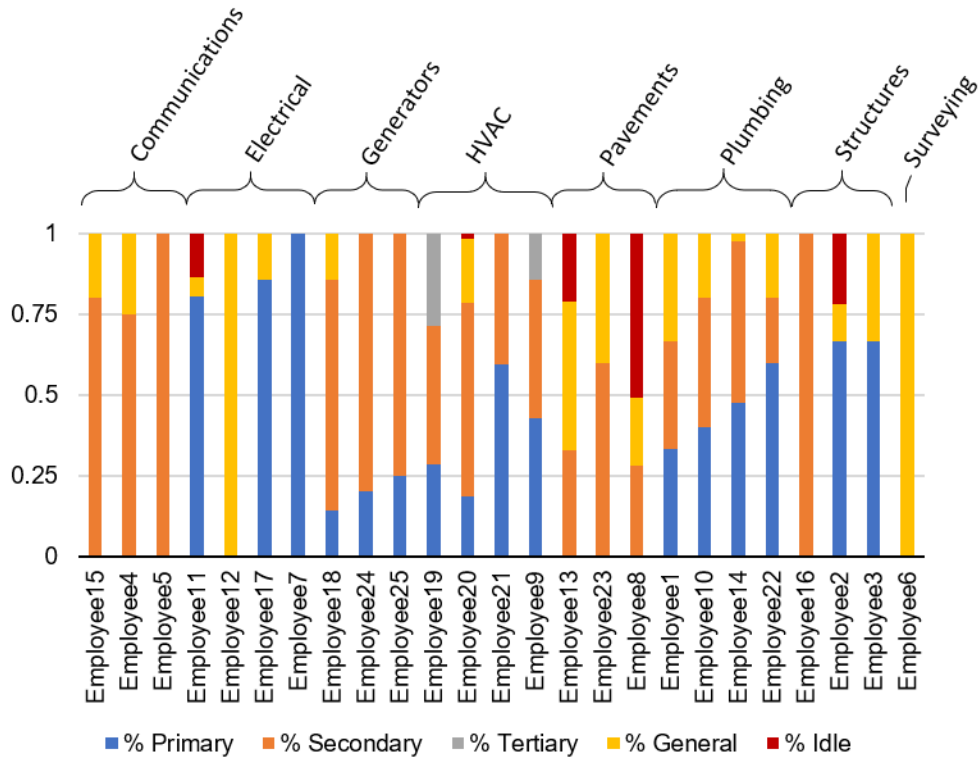

Fig. 6.3. Percent usage of skill per employee as they are grouped by craft

There was a slight preference for the journeyman skill level, which might indicate a balance between cost and competence. Figure 6.4 shows this slight preferential treatment based on usage of that skill level over others. The summation of usage does not add up to 100%, because not all the workers were needed during all the time periods under evaluation.

While overall least cost recovery strategies between flexible teaming models and parallel models are largely the same, the level of detail in organizing recovery crews is

superior in the flexible teaming models. This allows visibility into how it is best to utilize employees' skills and match them with requirements.

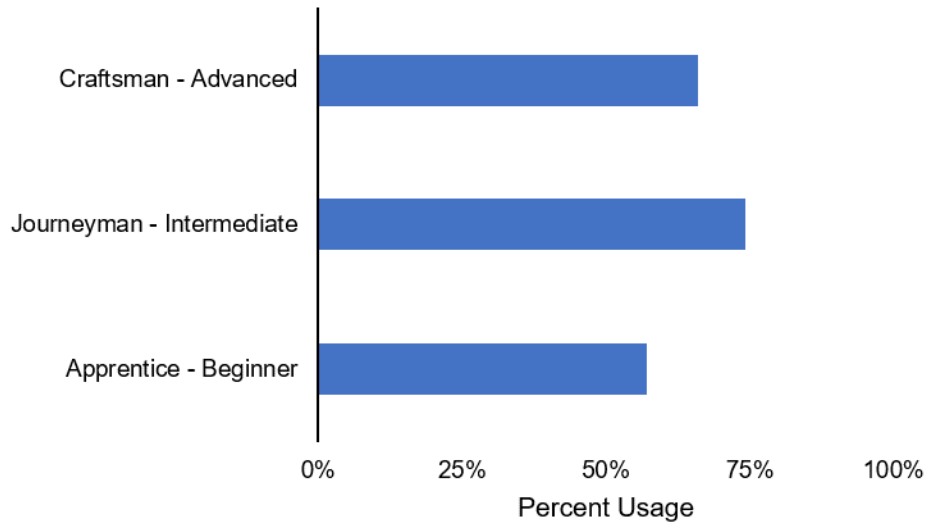

Fig. 6.4. Optimal assignment showed slight preference for intermediate skill level

6.5. Conclusions

Current modeling of interdependent civil infrastructure recovery uses parallel teams and does not consider the use of multiskilled personnel and flexible teaming structures. The presented MINLP or tmBIIRM incorporates team composition decision-making and skill-matching to improve visibility for optimal human capital management over the parallel teams. Recovery strategies are comparable between flexible teaming and parallel teaming models. Some improvements noticed in system operability can be due to several reasons to include teams can grow in size to more quickly handle large outages and problems. Improvement is also seen in work crews being able to divide time among

work tasks based on their skill sets, which can also cause some lag behind the non-preemptive environment assumed in the parallel teaming models.

Computational performance is slower in the tmBIIRM with an average time of 48 CPU minutes. The same damage scenarios using the BIIRM was less than 1 CPU minute. The increased team structure management would need to be weighed with the urgency of the recovery task. Due to the current computational time, this type modeling effort would best be utilized in planning and preventive analysis rather than in actual recovery operations. Future considerations include reduction of the computational time in order to make it a more viable option for recovery operations use as well as planning.

The assumptions and nuances of team management within recovery operations are largely overlooked in modeling and simulation. The incorporation of team composition and skill matching is an exciting development toward a closer approximation of real-world recovery operations and the necessary decisions that accompany these events.

VII. Model Behavior, Performance, and Limitations

7.1. Introduction

This chapter summarizes various efforts to fully understand the BIIRM's behavior, performance, and limitations. An emphasis is on the BIIRM model, since it serves as the base model for the LiteBIIRM and tmBIIRM models. This chapter is divided into three sections covering the behavior, performance, and limitations of the BIIRM.

7.2. Model Behavior

This section addresses the development of the objective functions and the integer-behavior of the BIIRM. The objective functions' development starts as a single-objective problem and becomes a multi-objective problem, and includes a discussion on the scaling of the objective functions. The integer-behavior of the BIIRM creates a disparity between the MIP and the linear relaxation or relaxed mixed-integer program (RMIP) of the BIIRM.

7.2.1. Single versus multiple objectives

The BIIRM was originally constructed using a single cost-centric objective with one other objective considered as a constraint using an ϵ -constraint method (Haimes et al. 1971). This idea mimicked the work of Almoghathawi et al. (2019) who used a similar approach in their resilience-focused MIP. It was thought that a modification to the ϵ -constrained resilience objective could be modified to provide a defense- and mission-focused objective. This constraint sought to give decision authority to a mission owner on the desired level of mission assurance represented by ϵ . This term mirrors a quantity

representing a network's resilience, where resilience is defined as $R(t) = \text{recovery}(t)/\text{loss}(t)$ (Almoghathawi et al. 2019).

Leveraging the notation from previous chapters, let the following additional notation be defined as follows:

- μ_{it}^k : Weight of node $i \in \mathcal{N}^k$ at time period $t \in \mathcal{T}$, which emphasizes repair to critical mission assets. This parameter takes a value from 1 to 100.
- $\delta_{t_d}^k$: The total weighted demand met in a given infrastructure $k \in \mathcal{K}$ at the time when all damage is known, t_d . This means that $\delta_{t_d}^k = \sum_{l \in \mathcal{L}^k} \sum_{i \in \mathcal{N}_D^k} \mu_{it}^k (-b_{ilt}^k - x_{ilt}^{-,k})$, at $t = t_d, \forall k \in \mathcal{K}$.
- $\delta_{t_0}^k$: The total weighted demand met in a given infrastructure $k \in \mathcal{K}$ at a time that is prior to the disruptive event, t_0 . This means that $\delta_{t_0}^k = \sum_{l \in \mathcal{L}^k} \sum_{i \in \mathcal{N}_D^k} \mu_{it}^k (-b_{ilt}^k)$, at $t = t_0, \forall k \in \mathcal{K}$. This assumes all demand is met prior to the disruptive event.
- δ_{ilt}^k : The weighted demand met of commodity $l \in \mathcal{L}^k$ at a demand node $i \in \mathcal{N}_D^k$ in infrastructure $k \in \mathcal{K}$ at time period $t \in \mathcal{T}$. This parameter is used strictly for a more concise notation and reflects $\delta_{ilt}^k = \mu_{it}^k (-b_{ilt}^k - x_{ilt}^{-,k})$.

With this notation defined, the following is the mission assurance ϵ -constrained objective described in Equation 7.1.

$$\sum_{k \in \mathcal{K}} \left[\frac{\sum_{\tau=1}^T \left[\tau \left[\sum_{l \in \mathcal{L}^k} \sum_{i \in \mathcal{N}_D^k} \delta_{ilt}^k - \delta_{t_d}^k \right] - (\tau-1) \left[\sum_{l \in \mathcal{L}^k} \sum_{i \in \mathcal{N}_D^k} \delta_{i\ell(\tau-1)}^k - \delta_{t_d}^k \right] \right]}{T(\delta_{t_0}^k - \delta_{t_d}^k)} \right] \leq \epsilon, \quad (7.1)$$

This represents the weighted recovery of all nodes over total loss. The numerator defines the change in demand met from time period $(t - 1)$ to t across all demand nodes

in a given network $k \in \mathcal{K}$. The first set of terms define the weighted demand met at a given time against the demand met after all damage has occurred. The second set of terms represents the same relationship at time period $(t - 1)$. The denominator is the total demand loss over all time periods. This expression was supposed to take a value between 0 and 1, with 1 being a fully capable mission (i.e., all critical demand met) and 0 being no mission (i.e., no critical demand met). Thus, the mission assurance objective becomes constrained by ϵ , which was able to be controlled by decision makers to achieve the desired target level of mission assurance.

This mission assurance objective became problematic during the actual runs of the model. Due to the nature of the variables and summing over different periods of time, the terms $\delta_{t_d}^k$ and $\delta_{t_0}^k$ had to be pre-determined and set in order for the constraint to work. This eliminated the dynamic nature that was intended during the formulation of the model to determine the level of mission assurance. This likely could have been overcome by setting up an initial run of the model over the necessary time periods with the necessary conditions (i.e., no damage then initial damage) in order to obtain the right values for the parameters. These initial runs could have been followed by a run of the full model. This could have been coded in GAMS to become automatic using iterative solve statements with submodel regimes including only the necessary equations. This possible solution was conceived after a different approach was adopted and was never fully tested.

The inability to leverage the mission assurance objective as a constraint left the BIIRM with only the cost-centric objective. Therefore, it is relevant to address the use of penalty costs in the cost-centric objective function. Following the pattern of González et al. (2016) penalty costs were used to incentivize flow. The penalty costs, $c_{it}^{+,k}$ and $c_{it}^{-,k}$,

were associated with the slack variables representing the surplus, $x_{ilt}^{+,k}$, and unmet demand, $x_{ilt}^{-,k}$. These are seen in an early version of the cost objective function in Equation 7.2, where the first and second terms are the repair and assignment costs for arcs, the third and fourth terms are the repair and assignment costs for nodes, the fifth and sixth terms are the surplus and unmet demand penalty costs, and the seventh term is the flow cost.

$$\begin{aligned} \text{Minimize}_{\alpha, x} \quad & \sum_{t \in \mathcal{T}} \sum_{k \in \mathcal{K}} \sum_{w \in \mathcal{W}^k} \left(\sum_{(i,j) \in \mathcal{A}^k} (q_{ijt}^k \alpha_{ijwt}^k + \alpha_{ijwt}^k \alpha_{ijwt}^k) + \right. \\ & \left. \sum_{i \in \mathcal{N}^k} (q_{it}^k \alpha_{iwt}^k + \alpha_{iwt}^k \alpha_{iwt}^k) \right) + \sum_{t \in \mathcal{T}} \sum_{k \in \mathcal{K}} \sum_{l \in \mathcal{L}^k} \left(\sum_{i \in \mathcal{N}^k} (c_{ilt}^{+,k} x_{ilt}^{+,k} + c_{ilt}^{-,k} x_{ilt}^{-,k}) + \right. \\ & \left. \sum_{(i,j) \in \mathcal{A}^k} (c_{ijlt}^k x_{ijlt}^k) \right). \end{aligned} \quad (7.2)$$

In a recovery-based cost minimization problem based on network flow, penalty costs were essential to incentivize flow. In a least-cost optimization with no penalty costs, the cheapest option is to do nothing (e.g., no repair, no flow). The complete reliance upon penalty costs is a departure from traditional network flow, where constraints of meeting demand ensure flow through the system, which are based on an underlying assumption of a completely functional network. Due to the nature of damaged nodes and arcs in recovery operations, some demand will not be met, thus the underlying nature of network flow changes in recovery scenarios.

An initial estimate of representative penalty costs were 10 times the cost of repair for a given node. However, the resultant objective value was extremely large (e.g., 1×10^9 magnitude) mainly due to the slack variables, $x_{ilt}^{+,k}$ and $x_{ilt}^{-,k}$, being non-binary and ranging from 0 to 500. These variables were multiplied by 10 times the largest cost parameter (i.e., repair cost), which could result in penalty costs as high as 5,000 times the

cost to repair a given node. The concerns over the penalty costs expressed by a mentor, a committee member, and other literature (González 2017) emphasized the benefits of a multi-objective construct balancing cost, time, and mission over the use of a single objective highly dependent on penalty costs.

A set of three objective functions oriented around cost, time, and mission – represented by unmet demand – was developed. These objectives are presented below in Equations 7.3 to 7.5. These equations represent a combined desire to minimize cost, minimize recovery time, and minimize the disruptive effect which is represented by unmet demand. They were combined in an overall weighted sum objective function as shown in Equation 7.6.

$$\begin{aligned} \text{Cost Objective: } A = & \sum_{t \in \mathcal{T}} \left(\sum_{s \in \mathcal{S}} g_{st} z_{st} + \right. \\ & \sum_{k \in \mathcal{K}} \left(\sum_{w \in \mathcal{W}^k} \left(\sum_{(i,j) \in \mathcal{A}^k} (q_{ijt}^k (\alpha_{ijwt}^k + \alpha_{ije wt}^k) + a_{wt}^k (p_{ij}^k \alpha_{ijwt}^k + e_{ij}^k \alpha_{ije wt}^k)) \right) + \right. \\ & \left. \left. \sum_{i \in \mathcal{N}^k} (q_{it}^k (\alpha_{iwt}^k + \alpha_{ie wt}^k) + a_{wt}^k (p_i^k \alpha_{iwt}^k + e_i^k \alpha_{ie wt}^k)) \right) + \sum_{l \in \mathcal{L}^k} \sum_{(i,j) \in \mathcal{A}^k} c_{ijlt}^k x_{ijlt}^k \right). \end{aligned} \quad (7.3)$$

$$\text{Time Objective: } B = \frac{1}{T} \sum_{t \in \mathcal{T}} \left(\sum_{i \in \mathcal{N}^k} \mu_{it}^k \tau_i^k + \sum_{(i,j) \in \mathcal{A}^k} \mu_{ijt}^k \tau_{ij}^k \right). \quad (7.4)$$

$$\text{Disruption Objective: } C = \sum_{t \in \mathcal{T}} \sum_{k \in \mathcal{K}} \sum_{l \in \mathcal{L}^k} \sum_{i \in \mathcal{N}^k} \frac{\mu_{it}^k x_{ilt}^k}{-b_{ilt}^k}. \quad (7.5)$$

$$Z = \mu_A A + \mu_B B + \mu_C C. \quad (7.6)$$

Equation 7.3 is similar to the cost function described as Equation 7.2 except that Equation 7.3 includes the assignment costs for node and arc repair at extended processing times as well as normal processing times. Equation 7.3 also removed the penalty costs due to the introduction of what should be competing objectives. Equation 7.4 seeks to

repair critical nodes and arcs as early as possible to minimize the time objective function value. The time objective function introduces new variables t_i^k and t_{ij}^k which are defined as $t_i^k = T - \sum_{t \in \mathcal{T}} y_{it}^k$, $\forall i \in \mathcal{N}^k, k \in \mathcal{K}$ and $t_{ij}^k = T - \sum_{t \in \mathcal{T}} y_{ijt}^k$, $\forall (i, j) \in \mathcal{A}^k, k \in \mathcal{K}$ for nodes and arcs, respectively. Equation 7.5 seeks to meet demand at critical nodes, by minimizing unmet demand at those same nodes. Table 7.1 identifies the controlling variables for each objective function. The time objective function (Equation 7.4) has an explicit dependence on the t variable, but also an implicit association with the y variable based on the above-mentioned relationships. Also, due to another constraint relating operability to having all of its demand met, the time function implicitly is associated with the x^- variable. The disruption objective function (Equation 7.5) has an explicit dependence on the x^- variable, but that slack variable is influenced on the repair of damaged nodes (α) and the flow of commodities through the system (x).

Table 7.1. Goals and variables for the cost, time, and disruption objective functions

Objective	Goal	Variables
Cost (A)	Minimizing	α and x
Time (B)	Minimizing	t (y and x^- implicitly)
Disruption (C)	Minimizing	x^- (α and x implicitly)

These three objective functions eventually were reduced to two after evaluating the effect or lack of effect between the various objectives. The next subsection illustrates this change and presents the finalized objective functions used in the BIIRM and other models.

7.2.2. Scaling and balancing the objective functions

In order to understand the nature of the multi-objective solution space a series of comparisons were run. The idea was to use one of the three objectives as the minimizing function, constrain a second, and let the third be free. Table 7.2 tabulates these runs and provides a description of the results which correlate with Figures 7.1 to 7.6. Each figure is explained individually below. The indicators A, B, and C refer back to Equations 7.3 to 7.5.

Table 7.2. Objective function analysis by minimizing one function, constraining another, and allowing the third to be free

Minimize	Constrained	Free	Descriptive Results
Cost (A)	Time (B)	Disruption (C)	Reflected curves (Fig. 7.1)
Cost (A)	Disruption (C)	Time (B)	Parallel flat lines (Fig. 7.2)
Time (B)	Cost (A)	Disruption (C)	Parallel curves (Fig 7.3)
Time (B)	Disruption (C)	Cost (A)	Parallel flat lines (Fig 7.4)
Disruption (C)	Cost (A)	Time (B)	Pseudo parallel lines* (Fig 7.5)
Disruption (C)	Time (B)	Cost (A)	Converging curves* (Fig 7.6)

* Solution was integer infeasible when run as a MIP, results are for runs as RMIP

Figure 7.1 shows the results of minimizing the cost objective while constraining time objective values from 20,000 to 2,000 in increments of 2,000. Only seven of the ten increments showed any results, with three being infeasible based on the constraints on time objective value. Figure 7.1 shows that cost decreased as the time lengthened and that disruption, in the form of unmet demand, increased over time. These were interesting results and seemed to indicate that if less was expended (in terms of repair, assignment,

and flow) then there would be more unmet demand (more disruption). While instinctively true, this is not what the model was intended to do and was the first indication that these objective functions were not properly configured.

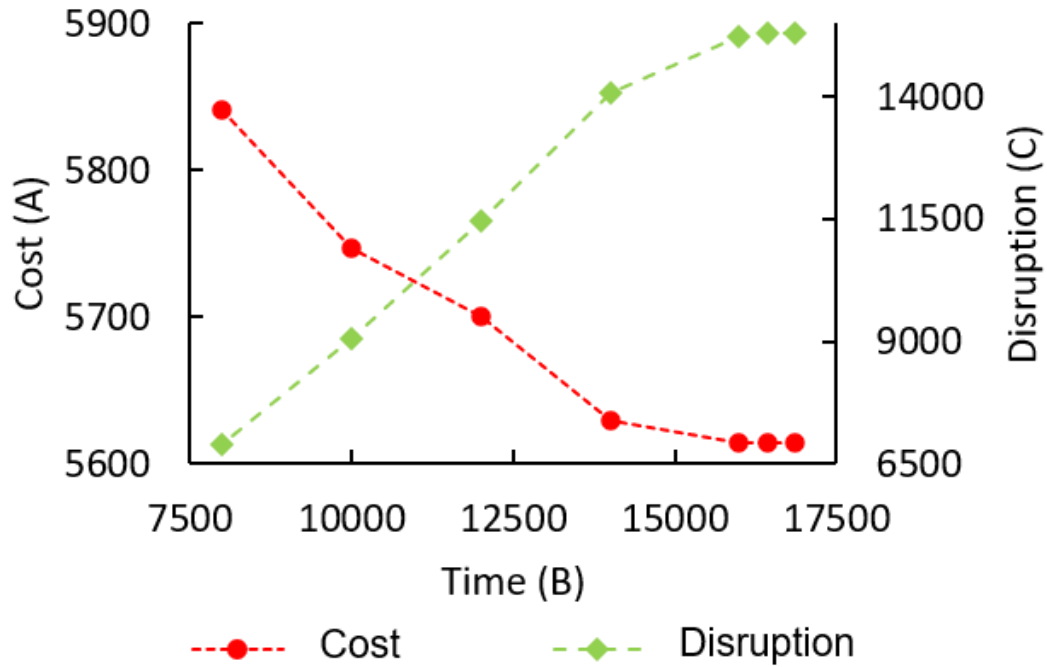

Fig. 7.1. Objective function analysis minimizing Cost (A) and constraining Time (B)

Figure 7.2 illustrates the results as the cost objective was minimized and disruption (unmet demand) was constrained from 10,000 to 1,000 in increments of 1,000. These results indicated that constraining the disruption objective function had no effect on either the cost objective or the time objective.

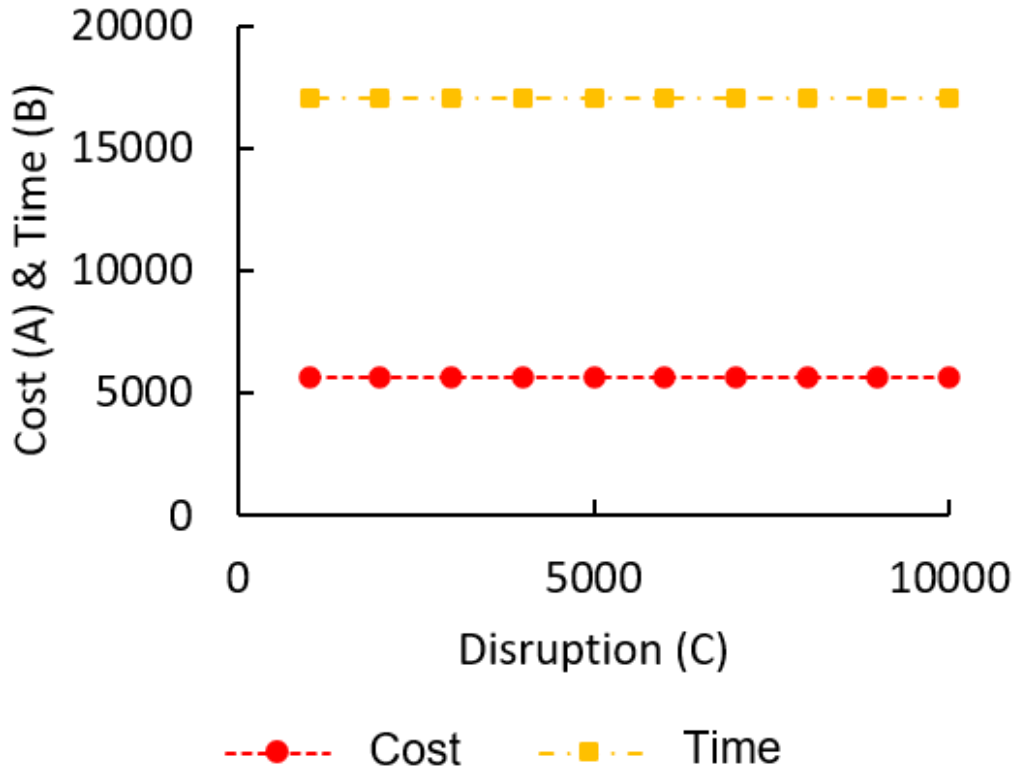

Fig. 7.2. Objective function analysis minimizing Cost (A) and constraining Disruption (C)

Figure 7.3 shows the results from minimizing the time objective while constraining the cost objective from an objective value of 10,000 to 1,000 in increments of 1,000. The model only produced results when the cost objective was between 9,000 and 6,000 and at all other times was infeasible due to the cost constraints. These results were closer to what was expected. With an increase in cost, the time to repair could be decreased and the unmet demand would decrease. The slight non-linear behavior was likely due to non-uniform repair costs, repair time, and demand.

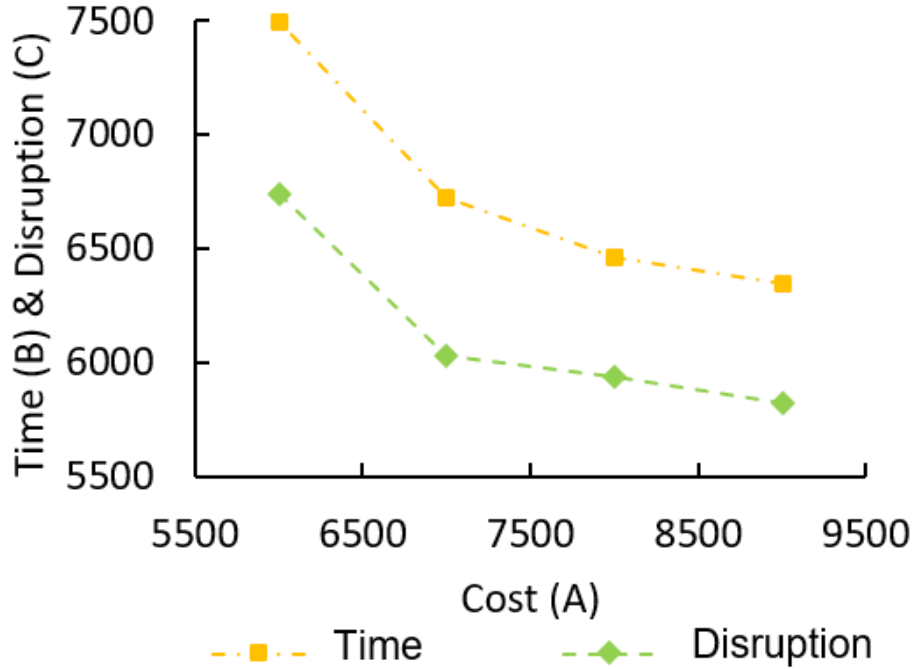

Fig. 7.3. Objective function analysis minimizing Time (B) and constraining Cost (A)

Figure 7.4 illustrates the results as the time objective was minimized and the disruption (unmet demand) objective was constrained from an objective value of 20,000 to 2,000 in increments of 2,000. Similar to Figure 7.2 constraining the disruption objective had no effect on the cost and time objectives.

All combinations trying to minimize the disruption objective function and constraining either the cost or time functions were infeasible using the standard MIP. It was unclear why this was happening, but trying to minimize unmet demand with a damaged network would set all x^- variables to zero causing several equations to become infeasible. However, when the program was run as a relaxed mixed-integer program (RMIP) there were some results which are shown in Figures 7.5 and 7.6.

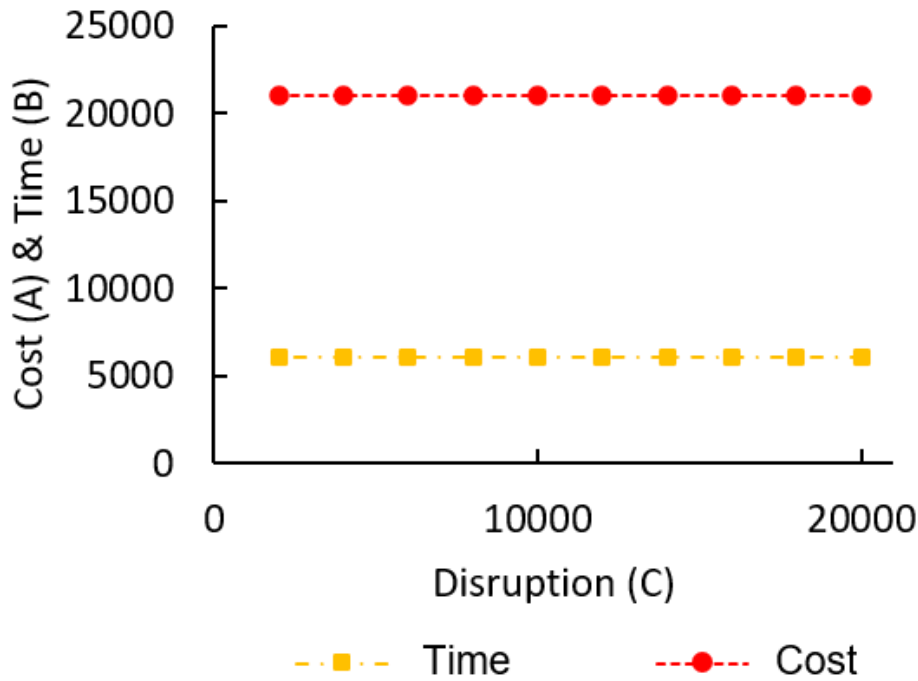

Fig. 7.4. Objective function analysis minimizing Time (B) and constraining Disruption (C)

Figure 7.5 shows the results of minimizing the disruption objective function as an RMIP while constraining the cost objective function from 10,000 to 1,000 in increments of 1,000. These results show minimal change in both the time objective function value and disruption function value when constraining the cost objective.

Figure 7.6 illustrates the results of minimizing the disruption objective function as an RMIP while constraining the time objective from 20,000 to 2,000 in increments of 2,000. These results are similar to those seen in Figure 7.1 with a general decrease in cost and a general increase in disruption as time increases. However, there are some inconsistencies within the general trend, notably the sharp dip in cost at the constrained time objective value of 12,000.

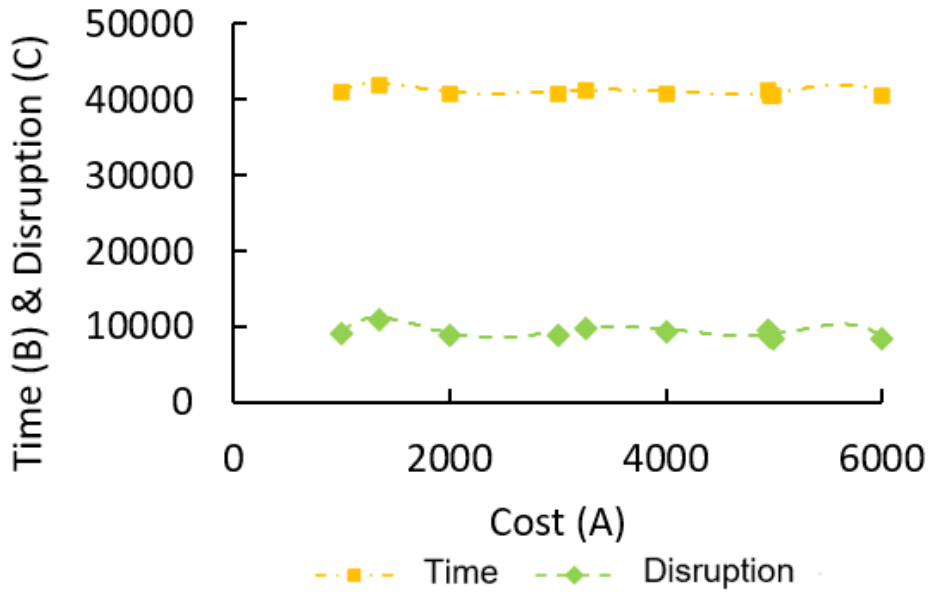

Fig. 7.5. Objective function analysis as RMIP minimizing Disruption (C) and constraining Cost (A)

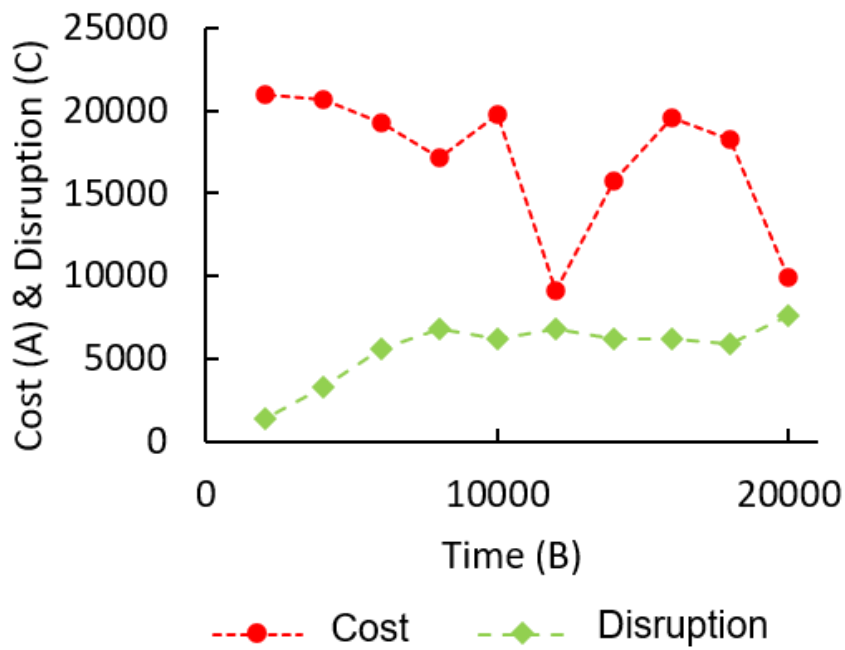

Fig. 7.6. Objective function analysis as RMIP minimizing Disruption (C) and constraining Time (B)

Based on the analysis, it was determined that the tri-objective configuration was inappropriate and not performing as desired. The behavior of the objective functions on one another are thought to be due to implicit associations between the variables. While each objective on the surface seemed to be independent of one another, several constraints created complex relationships that affected the behavior. It was determined that the two independent variables were x and α which explain how commodities flow through the system and what is scheduled for repair. All the other variables are dependent upon these two and combinations of other variables.

The objectives were reconfigured to include a cost objective and an operability objective. The latter objective effectively combined the time and disruption objectives into one objective seeking to maximize the overall system operability. These equations as they are used in the BIIRM are again listed here as Equations 7.7 and 7.8. These two explicit objective functions constitute the multi-objective functions used in the LiteBIIRM, BIIRM, and tmBIIRM (see Chapters 4 to 6) and are combined in a weighted summation shown in Equation 7.9. Table 7.3 compiles the objectives, goals, and associated variable when applicable. The cost objective is maintained in much the same form with the goal of minimizing costs. The second objective is operability, which seeks to maximize the overall operability of the system. Although there are only two explicit objective functions, the use of a time index on variables and parameters allows for a semblance of maintaining a third objective.

$$\text{Cost Objective: } A = \sum_{t \in \mathcal{T}} \left(\sum_{s \in \mathcal{S}} g_{st} z_{st} + \sum_{k \in \mathcal{K}} \left(\sum_{w \in \mathcal{W}^k} \left(\sum_{(i,j) \in \mathcal{A}^k} (q_{ijt}^k (\alpha_{ijwt}^k + \alpha_{ije_{wt}}^k) + a_{wt}^k (p_{ij}^k \alpha_{ijwt}^k + e_{ij}^k \alpha_{ije_{wt}}^k)) \right) \right) \right)$$

$$\sum_{i \in \mathcal{N}^k} (q_{it}^k (\alpha_{iwt}^k + \alpha_{e_{wt}}^k) + a_{wt}^k (p_i^k \alpha_{iwt}^k + e_i^k \alpha_{e_{wt}}^k)) + \sum_{l \in \mathcal{L}^k} \sum_{(i,j) \in \mathcal{A}^k} c_{ijlt}^k x_{ijlt}^k \Big). \quad (7.7)$$

$$\text{Operability Objective: } B = \sum_{t \in \mathcal{T}} \sum_{k \in \mathcal{K}} (\sum_{i \in \mathcal{N}^k} \mu_{it}^k y_{it}^k + \sum_{(i,j) \in \mathcal{A}^k} \mu_{ijt}^k y_{ijt}^k). \quad (7.8)$$

$$Z = \mu_A A - \mu_B B. \quad (7.9)$$

Table 7.3. Goals and variables for the cost, operability, and time objective functions used in the LiteBIIRM, BIIRM, and tmBIIRM

Objective	Goal	Variables
Cost (A)	Minimizing	α and x
Operability (B)	Maximizing	y
Time	N/A	None, but uses time index

The relationship between the cost objective (Equation 7.7) and the operability objective (Equation 7.8) was found by minimizing the overall objective Z , while varying μ_A and μ_B , which sum to one to create a convex combination of the two objective functions. Figure 7.7 shows this convex combination of the two explicit objective functions. This relationship establishes the intuitive connection that little investment in repair will yield poor operability within the damaged system. Of interest is what can be seen as diminishing returns as significant resources are added to the repair without significant changes in the operability.

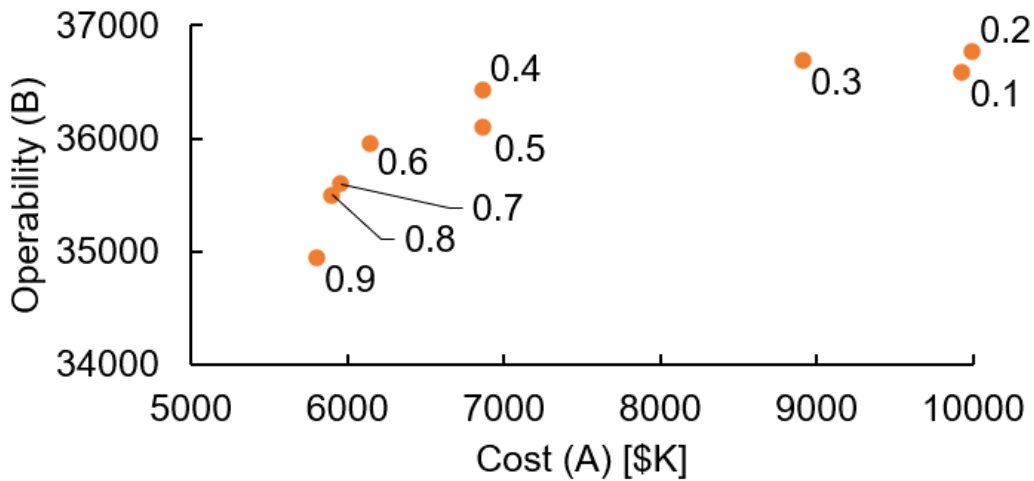

Fig. 7.7. Convex combination of the cost objective function and the operability objective function with μ_A values annotated by each data point

The relationship between cost and operability as seen in Figure 7.7 and explained in Equations 7.7 to 7.9 establish the competing nature of the multi-objective space. In order to understand the nature of the MIP, a linear relaxation was completed and is discussed in the following subsection.

7.2.3. Disparity between integer program and linear relaxation of the integer program

A relaxed mixed-integer program (RMIP) is a method used in order to relax the integer constraints within a given upper and lower limit bounded by the original integer boundaries. This relaxation helps determine the super-optimal objective value where the integer solution can only be as good as the relaxed linear solution and not to exceed it (Bazaraa et al. 2009). The BIIRM MIP was converted to a RMIP easily by virtue of redefining the model type in GAMS. The CPLEX solver was still used to ensure

continuity between solving methodologies. All other parameters and the damage scenario remained the same between the two different runs.

Figure 7.8 illustrates the MIP versus RMIP convex combination results and show a large disparity in terms of the operability objective value especially in the terminal operability value for each run, respectively. This means the RMIP is able to achieve significantly better operability results. The two runs also exhibited an increasing disparity in cost when evaluating the difference of costs at the initial and terminal points of the runs, respectively. The initial gap was close to \$6M and the end gap was close to \$8M.

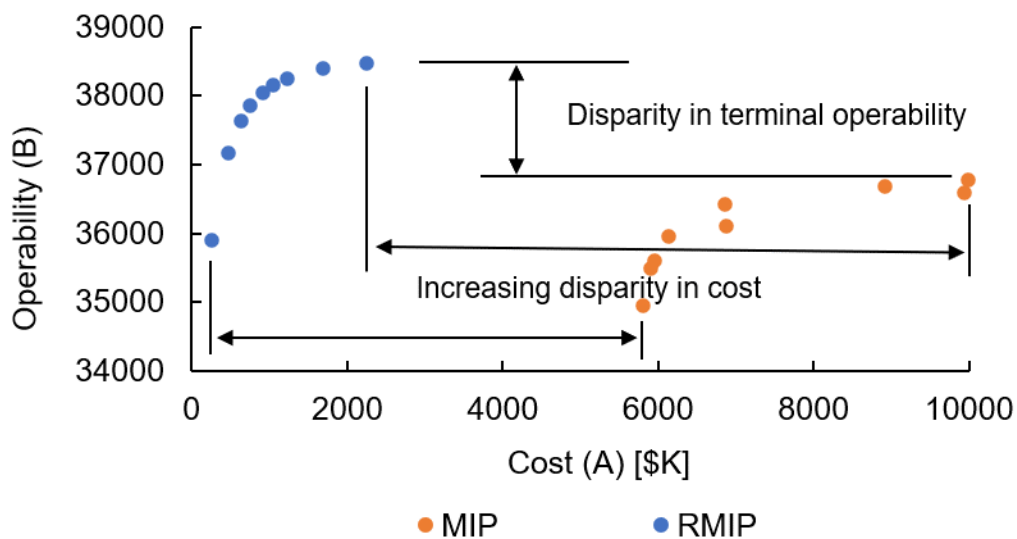

Fig. 7.8. Disparity between the RMIP and MIP existed in the terminal operability as well as an increasing disparity in the cost

An investigation into this disparity showed that the allowance of partial assignments compounded the disparity in terms of both cost and operability. The assignment variable, α , was allowed to take on any value from 0 to 1 across multiple nodes not to exceed summing to 1 in any given time period. This changed the underlying

assumption that a crew is assigned to a given node from the start of repair until complete. Effectively, this meant that a work crew could be assigned for a portion of the time period on one recovery task, then another, and so on until they had been assigned for an entire work period. This alone is not a large problem, but this partial assignment combined with the constraints shown in Equations 7.10 and 7.11 led to disparity in the operability objective values. A partial assignment could sum over a number of time periods to become a completed node, thus increasing the operability at a minimal cost based on a one-time partial assignment.

$$\beta_{iwt}^k \leq \sum_{\tau=1}^{\min[T, t-p_i^k]} \alpha_{iwt}^k, \quad \forall i \in \mathcal{N}^k, w \in \mathcal{W}^k, k \in \mathcal{K}, t \in \mathcal{T}. \quad (7.10)$$

$$\beta_{ijwt}^k \leq \sum_{\tau=1}^{\min[T, t-p_{ij}^k]} \alpha_{ijwt}^k, \quad \forall (i, j) \in \mathcal{A}^k, w \in \mathcal{W}^k, k \in \mathcal{K}, t \in \mathcal{T}. \quad (7.11)$$

A quick example is demonstrative and provides a tangible example of what happens during the relaxation. At time period 1, work crew “wTERa” was assigned to a recovery task at Node 22 with $\alpha_{22, wTERa, 1}^{TER} = 0.125$. At time periods 2 to 9, the repaired value was repeatedly $\beta_{22, wTERa, 2 \text{ to } 9}^{TER} = 0.125$, which over eight time periods summed to be equal to 1, representing a completely repaired asset. This relaxation essentially created unrealistic assignments, which compounded the level of disparity for operability and cost at each successive time period. Figure 7.9 shows some model output highlighting the assignment and the recurring repair values over multiple time periods as described above.

ALPHA (ASSIGNMENT)		LEVEL	LEVEL	
I.K.T.W or I.J.K.T.W		▼ RUN156 ▼	RUN166 ▼	▼ MIP ▼
22	.TER.t1 .wTERa			0.125
BETA (REPAIRED)		RUN166(RMIP)		
I.K.T.W or I.J.K.T.W		▼ LOWER ▼	▼ LEVEL ▼	▼ UPPER ▼
22	.TER.t2 .wTERa	.	0.125	1.
22	.TER.t3 .wTERa	.	0.125	1.
22	.TER.t4 .wTERa	.	0.125	1.
22	.TER.t5 .wTERa	.	0.125	1.
22	.TER.t6 .wTERa	.	0.125	1.
22	.TER.t7 .wTERa	.	0.125	1.
22	.TER.t8 .wTERa	.	0.125	1.
22	.TER.t9 .wTERa	.	0.125	1.

Partial assignment at time period 1.

Partial assignment sums to completely repaired node by time period 9.

Fig. 7.9. An example of a partial assignment, α , at time period 1, and summing over eight time periods as the repaired variable, β

Having identified likely the main issue, an additional constraint was added to lessen the effect of the relaxation. Equations 7.12 and 7.13 are a modified versions of Equations 7.10 and 7.11 which sum over t and w . This effectively means that amount of repair must be less than or equal to the sum of assignments.

$$\sum_{t \in \mathcal{T}} \sum_{w \in \mathcal{W}^k} \beta_{iwt}^k \leq \sum_{t \in \mathcal{T}} \sum_{w \in \mathcal{W}^k} \alpha_{iwt}^k, \quad \forall i \in \mathcal{N}^k, k \in \mathcal{K}. \quad (7.12)$$

$$\sum_{t \in \mathcal{T}} \sum_{w \in \mathcal{W}^k} \beta_{ijwt}^k \leq \sum_{t \in \mathcal{T}} \sum_{w \in \mathcal{W}^k} \alpha_{ijwt}^k, \quad \forall (i, j) \in \mathcal{A}^k, k \in \mathcal{K}. \quad (7.13)$$

The addition of the two RMIP constraints produced similar cost growth among the two runs and nearly eliminated the initial operability disparity. Figure 7.10 shows the addition of the modified RMIP into the original RMIP and MIP. The modified RMIP and MIP have similar cost growth of close to \$4.5M, but still maintain a disparity between the two sets of values. The initial operability disparity was nearly eliminated, but the terminal operability disparity persisted. In general, the shape of the modified RMIP and MIP are more similar than the MIP and the original RMIP.

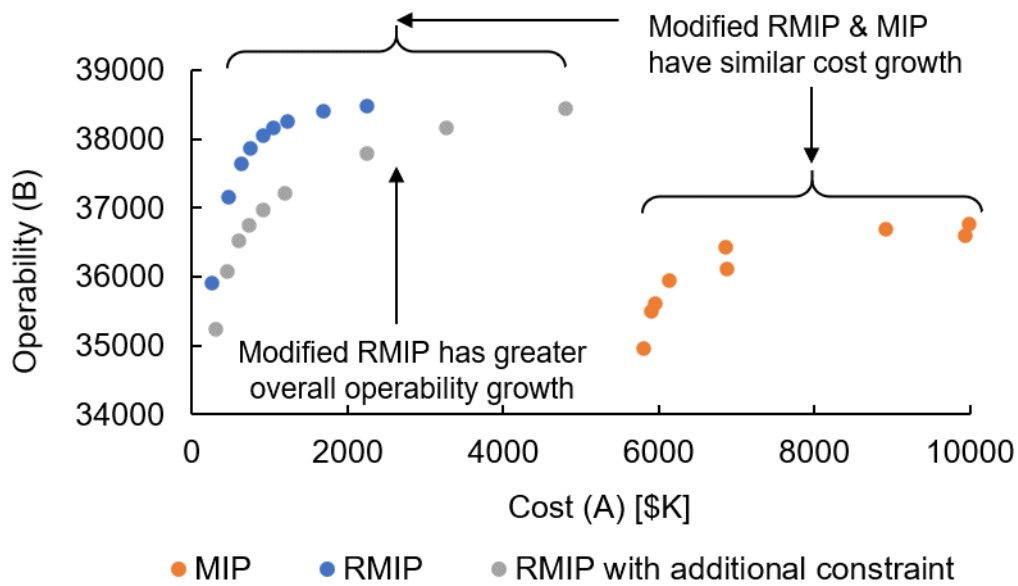

Fig. 7.10. The addition of RMIP constraints corrects the initial operability disparity and maintains the cost disparity rather than increasing it

This concludes the notes regarding the underlying behavior of the BIIRM and the development of the objective functions used in this research. The next section discusses the BIIRM performance in terms of precision and computational time.

7.3. Model Performance

The model's performance can best be described by precision and computational time. Precision is used as a model performance measure since there is no established "correct" answer to assess accuracy. One way to evaluate precision is the model's tendency toward the true optimal as the relative optimality gap decreases, where the relative optimality gap is described in a later subsection. Computational time is a commonly used model performance metric and is important when basing decisions off IIR model output (Cavdaroglu et al. 2013; Lee et al. 2007).

7.3.1. Performance based on the number of time periods

A series of 25 runs were performed with an increasing number of time periods. Run number 1 evaluated 1 time period, run 2 evaluated 2 time periods, and so on to run 25 with 25 time periods in the evaluation window. These runs used a damage scenario identical to the one described in Chapter 5. The objective functions were balanced between cost and operability (i.e., $\mu_A = \mu_B = 0.5$). The resulting increase in computational time appeared to be polynomial in nature with some anomalies at time periods 19, 21, and 22. The total computational time increased from less than one second to 879 seconds (14.6 minutes) as shown in Figure 7.11.

The first runs with one, two, and three time periods, respectively, did not experience any repair or flow costs. The lack of expenditure is due to too short an evaluation window. The small number of time periods was too short to effectively make expending resources worth it to see an increase in the operability and thus decrease the overall objective function. While no recovery effort is not an acceptable option typically in disaster scenarios, it should be noted that a sufficient quantity of time periods is required in order to ensure the model functions properly. The number of time periods that are deemed sufficient will be unique to the damage scenario, the repair times, and how time periods are defined.

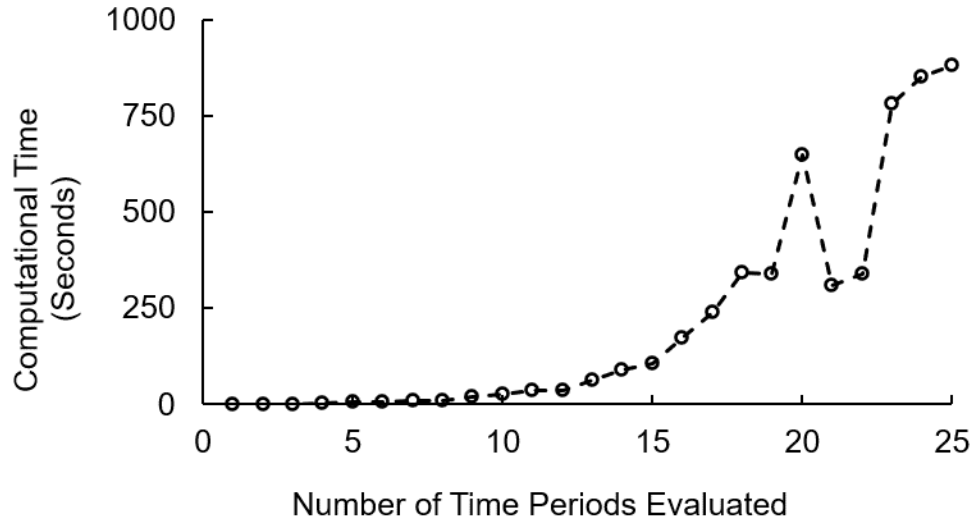

Fig. 7.11. Computational time experienced polynomial growth with some anomalies as the number of time periods being evaluated increased

This shows that although the computational time increases with the number of time periods being evaluated, every run was less than 15 minutes. The following subsection discusses the performance with respect to relative optimality.

7.3.2. Performance based on the relative optimality gap

GAMS and the global solver CPLEX use a relative termination tolerance for optimality. This relationship is described by a ratio between 1) the difference between the primal and dual bounds and 2) the maximum of the absolute value of the primal and dual bounds (GAMS Development Corp. 2021). This is mathematically shown in Equation 7.14 where PB stands for primal bound and DB stands for dual bound. Therefore, PB in this case is the objective function value of the best feasible solution and DB is the lower bound of the problem since it is a minimization problem.

$$|PB - DB| / \max(|PB|, |DB|). \quad (7.14)$$

This termination criterion is used within the GAMS model as a way to ensure the returned solution is within a certain percentage of the true objective value. The solver will stop as soon as a feasible solution is proven to be within the tolerance of the optimality gap. For instance an optimality gap of 0.01 means that the objective value will be within 1% of the true objective value (GAMS Development Corp. 2021).

Table 7.4 combines the results of the computational time associated with the various relative optimality gaps. The table provides the range of computational time for generating the convex combination based on a specified optimality gap as well as the average time in seconds. The series of runs used the same damage scenario as explained in Chapter 5 for consistency. Only two instances when the optimality gap was set to 0.01% timed out after a 24hr computational time, having only achieved up to that point a relative optimal gap of 0.06% and 0.02%, respectively. These high computational times were both associated with a low weighting on the cost function (i.e., $\mu_A = 0.1$ and 0.2) and a high weighting on the operability function (i.e., $\mu_B = 0.9$ and 0.8). All other computational times for 0.01% optimality gap averaged at 543 seconds. The two longest computational times for optimality gap equal to 0.1% were the same weighting scenarios, which made the average for that time so much higher than the previous ones. Excluding the two highest computational times from the 0.1% optimality gap reduces the average time to 195 seconds.

Table 7.4. Range of computational time and average time for solving the same problem with different specified optimality gaps

Optimality Gap	Range of Time (sec)	Average Time (seconds)
10%	7 to 36	20
5%	14 to 37	21
1%	15 to 36	23
0.1%	21 to 3080	698
0.01%	21 to 86400 ^a	19616

^a Upper threshold for runtime was set at 86,400 seconds (24 hrs), which was reached twice ($\mu_A = 0.1, \mu_B = 0.9$ & $\mu_A = 0.2, \mu_B = 0.8$)

The convex combinations were plotted based on the associated relative optimality gap (Figure 7.12). This analysis showed close clustering except for a couple of the extreme cases. Namely, when $\mu_A = 0.1$ and $\mu_B = 0.9$ the spread between the costs were the greatest, though the operability objective value were nearly the same. In general, the 10%, 5%, and 1% optimality gap objective values tended to cluster together, while the 0.1% and the 0.01% optimality gap objective values did as well. Another exception was when $\mu_A = 0.8$ and $\mu_B = 0.2$, where the 10% optimality gap cost and operability objective values were closer aligned to when cost was fully weighted. All other values in this instance clustered tightly. This shows that the computational time burden is minimal in most instances a 1% or 0.1% optimality gap is sufficient for this scenario.

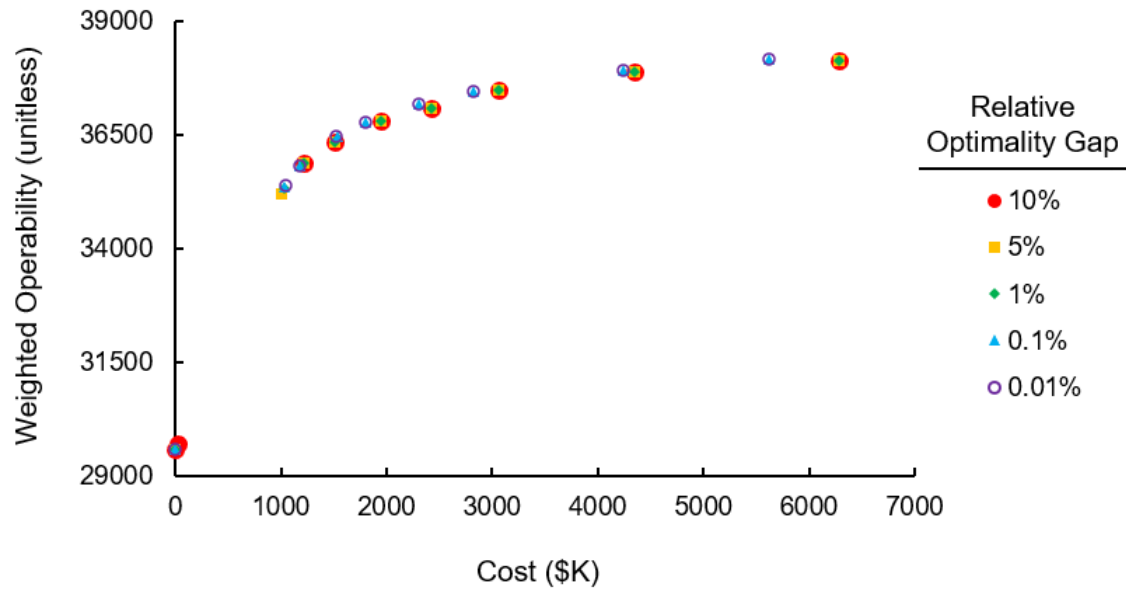

Fig. 7.12. A series of convex combinations with varying relative optimality gaps

These simple analyses showed that the model is able to perform efficiently with the damage scenario and instance size presented thus far. The following section discusses model limitations.

7.4. Model Limitations

This section discusses the known limitations of this model as presently formulated. First it discusses the scalability from smaller to larger datasets and then it discusses the possible solution and use of heuristics.

7.4.1. Scalability to larger datasets

A choice was made early on to employ a multilayered network approach. Typically there are three styles of multilayered networks: multi-plex, multi-slice, and network-of-networks (Bianconi 2018). The difference is in the mapping and temporal nature of the layers. In multi-plex cases the nodes map one-to-one in each layer and are reflected into layers as necessary. The multi-slice structure uses changes over time with a

one-to-one mapping of nodes. The network-of-network structure discards the one-to-one mapping.

Based on interpretation of academic literature it seemed infrastructure networks were most often modeled as either multi-plex or network-of-network structures. Literature seemed to promote multiplex as typical for infrastructure and this method was selected (Bianconi 2018; Buldyrev et al. 2010; González et al. 2016). Multi-plex network structure was useful in order to evaluate operational interdependencies. However, recovery operations involve a temporal nature of change in the system and required a multi-slice approach. The multi-slice approach was required to examine the restoration interdependencies. These choices created a complex structure of a multi-plex structure within a multi-slice structure to exploit the analysis of both operational and restoration interdependencies (Figure 7.13).

This structural decision of the model has consequences on instance size. The CLARC database comprises 1,305 nodes and 4,764 arcs (Sharkey et al. 2018). However, when restructured for use in the BIIRM the nodes increased to 3,020 and the arcs increased to 4,780. This caused problems within the execution of the BIIRM using GAMS which started with an extremely large file and quickly would run into heap limits, which is a way to describe memory management within the program.

Challenges with the full CLARC dataset and the desire to develop a military installation-sized dataset were both influential in reducing the CLARC dataset into what was used in this research. Additional information is provided in Appendix A on the evaluation of the CLARC Database and the construction of the BIIRM Multi-plex dataset.

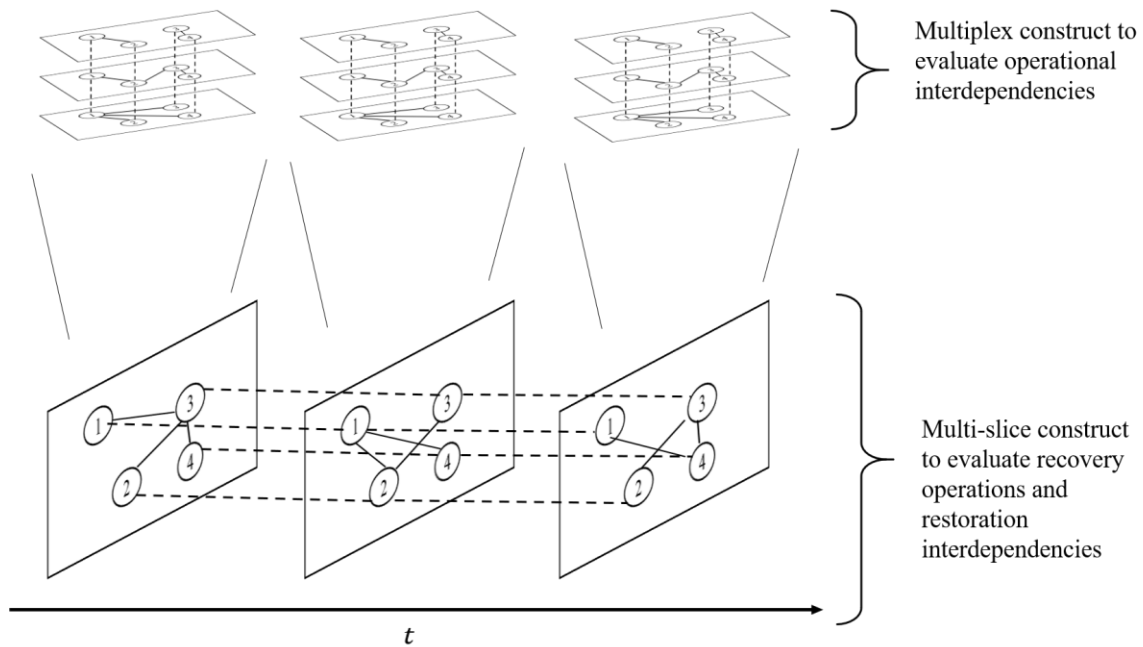

Fig. 7.13. The BIIRM represents a complex multilayered construct using a multi-plex structure to evaluate operational interdependencies and a multi-slice structure to evaluate restoration interdependencies

In summary of this subsection, structural changes to evaluate the operational and restoration interdependencies have caused undue burden on computational time and memory capacities. While this research is studying more relationships than others like Sharkey et al. (2015), the network size is approximately 10% of the original CLARC dataset. Therefore, the BIIRM model currently does not scale to very large instances to include the region-sized CLARC dataset.

7.4.2. Using heuristics and modifications

Possible solutions to the scalability limitations may be achieved by using heuristics or modifications to the BIIRM. Several heuristics were employed in similar IIR research to include heuristics to decrease the computational burden due to indexing time

periods (González et al. 2016), create better repair assignments (Nurre et al. 2012), and simulate different stakeholder information sharing (Sharkey et al. 2015). Additional solution strategies have also been used in network evaluation to include L-decomposition (González 2017) and Bender's cuts (Kennedy 2003).

Additional solution methods and heuristics have not been extensively explored to determine the feasibility of their use with the BIIRM. In particular, a stochastic solver might be able to overcome the limitations currently experienced with increased instance sizes. This is an area of significant future work.

Modifications to the BIIRM are also possible. One particular assumption seems to largely drive the necessity of using a multi-plex structure, which doesn't seem to exist for other models. That assumption is that arcs can operate only within a given network and flow commodities within a given network. An example of this besides the current research is the work of González et al. (2016). A counter example is in the work of Sharkey et al. (2015), where arcs go from one network layer to another and establish the interdependencies. This latter example may, in particular, be why Sharkey et al. (2015) were able to run analysis on the CLARC Database outside of not examining additional interdependencies and coupling strategies.

7.5. Conclusions

This chapter examined the underlying model behavior, performance, and limitations. The behavior of the model is largely based on the objective functions used and the nature of the MIP. In particular the behavior of the BIIRM is driven by the binary nature of the assignment variable α . The performance of the BIIRM is such that precise solutions are achievable in relatively short time spans based on the damage scenario and

instance size evaluated. The limitations of the model are the current challenges with scalability to larger instance sizes. These challenges might be able to be overcome by employing heuristics or by the use of stochastic solvers.

VIII. Conclusions and Recommendations

8.1. Introduction

This chapter compiles the key contributions and main conclusions of this research. This chapter also identifies recommendations for future work. There are three main sections in this chapter. First, a section restates the research objectives and discusses how they have been answered. Second, there is a section for the research conclusions and contributions to the body of knowledge regarding interdependent infrastructure recovery (IIR). Third, there is a place for recommendations for future work.

8.2. Review of Research Objectives

The primary objective of this research was to develop a defense-focused interdependent infrastructure recovery (IIR) model balancing cost, repair time, and operability. This was achieved with the creation of a mixed-integer program using multiple objectives addressing cost and operability explicitly, and including repair time implicitly with the use of a time-based index. The primary model was denoted as the base interdependent infrastructure recovery model (BIIRM).

There were three additional research questions which influenced the direction and scope of the present research. These are listed below, followed by a brief answer to the questions.

- Q: How can multiple and various interdependency subtypes and coupling strategies be simultaneously be incorporated into an IIR model?

A: The operational interdependency subtypes and coupling strategies were integrated using a modified interdependency parameter, $\gamma_{ii\psi\xi t}^{k\bar{k}}$, where this term took on different values based on the interdependency subtype and coupling

strategy. The restoration interdependency subtypes and asset-to-asset coupling strategies were incorporated through a series of constraints, mainly precedence related.

- Q: How do multiple and various interdependency subtypes and coupling strategies affect the cost, repair time, and operability of disrupted infrastructure networks?

A: The exclusion of operational interdependencies tends to give false impressions about infrastructure systems, overestimating operability in times of disruption.

Overestimating operability also includes analyses with only one operational interdependency subtype. The inclusion or exclusion of restoration interdependencies causes both over and under estimating on cost, repair time, and operability, but the effects are situation-specific. It is most accurate to include all the various interdependency subtypes when available.

- Q: How does work crew management including flexible team composition, training, and education of recovery personnel affect the recovery of interdependent infrastructure networks?

A: The ability to divide teams into multi-skilled composites, rather than rigid parallel teams with all assumed skills, was powerful in determining optimal strategies. This showed tailored response to the needs of the repair tasks and not trying to make do with one-size-fits-all.

These research questions formed a basic framework to approach the research.

This research addressed these questions and also touched on tangentially related topics.

The following section discusses the research conclusions and contributions.

8.3. Research Conclusions and Contributions

This section summarizes the conclusions and contributions to the body of knowledge this research has accomplished. This is done by categorizing conclusions and contributions based on literature review, coupling, interdependencies, modeling, and data.

8.3.1. Conclusions from literature review

Two main conclusions can be drawn from the literature review examining network-based IIR models. First, most IIR models pursued at least one of three primary objectives focused on cost, repair time, and system operability or performance. While the approaches and techniques differed on how to examine and quantify each of these objectives, it became apparent that these three objectives constitute the basis of the recovery operations trilemma. The recovery operations trilemma defines the tradespace balancing cost, repair time, and system operability. The identification of this trilemma is beneficial for stakeholders, modelers, and emergency managers as they seek to use this frame of reference for future efforts in IIR.

Second, the identification of characterizing assumptions is beneficial to current and future efforts to improve modeling and simulation of IIR. Eight different assumptions were prevalent and only superficially addressed across the IIR models examined. The eight characterizing assumptions are: teaming structures, sufficient resources, negligible transit time, work efficiency, no degraded conditions, no external support, compressed phases of recovery, and success of recovery. Assumptions are often made about these elements of recovery operations and may not be valid in all instances, thus making models less representative of actual conditions. Identification of these characterizing assumptions allows future work to challenge these assumptions when appropriate.

Challenging prevailing assumptions, to include building upon the limited work already accomplished, will improve IIR modeling.

8.3.2. Conclusions about coupling

Four contributions regarding coupling are appropriate to highlight. First, this research presented the first model to simultaneously integrate all four of the tight or linear coupling strategies identified by González et al. (2016). These coupling strategies were identified as one2one, one2any, one2all, and one2many. Second, nuances associated with integration of all four coupling strategies were detailed for models treating operability as binary and non-binary. The differences are particular to each case and require slight modifications to previously presented or explained relationships. Third, in models using a non-binary operability variable, the addition of a pseudo-node in connection with the one2many coupling can allow system modeling nodes that maintain some level of operability despite disturbances or some degradation. This is particularly useful, since this mimics many known systems that still function with manual overrides, but at a reduced capacity or responsiveness when control systems are in need of system maintenance. Fourth, coupling strategies can be used to overcome some data accessibility issues in lieu of obtaining full data. The combination of partial data plus additional interdependencies to compensate for the missing infrastructure data yielded results within 3% of the dataset representing complete data. These contributions exemplify the power of incorporating coupling into IIR models.

8.3.3. Conclusions about interdependencies

This research made three contributions to the modeling and understanding of interdependencies. First, this research is the first to simultaneously integrate nine

different interdependency subtypes within a single IIR model. This enables a modeler to identify multiple interdependencies between systems and evaluate the effect of these relationships on the entire system in terms of cost, repair time, and operability. Second, the combination of multiple interdependency subtypes and coupling strategies allows a system modeler to articulate complex, multiple, and compounding interdependent relationships. This is a unique modeling capability due to the inherent ability in the model formulation rather than establishing unique sets and constraints in other work (González et al. 2016; Lee et al. 2007). Third, a method for identifying node pairs that might experience interdependent relationships was developed through the process of nodal examination in a multi-plex structure. Details regarding this nodal analysis are found in Appendix A.

8.3.4. Conclusions about modeling

Several improvements to existing models have been highlighted already and this subsection suggests improvements based on this research to benefit all network-based IIR modeling. Models are often unique and specific and, therefore, are difficult to compare output or results from one model to another. To aid in overcoming this challenge three concluding thoughts are proposed to help model evaluation and selection.

1. Incorporate the recovery operations trilemma framework to establish and discuss model focus and objectives. This may help articulate how a given model addresses or does not address these three critical elements of interdependent infrastructure recovery operations.
2. Establish and clearly articulate which interdependency subtypes and coupling strategies are able to be used within a given model. Incorporating more

interdependencies is not necessarily the goal, but rather calculated and intentional inclusion of the appropriate interdependencies for the scenario is the goal for modeler and stakeholders alike.

3. Identify characterizing assumptions within a given model. This should influence model transparency and provide stakeholders with better information to make decisions on appropriate models for the scenarios of interest.

These three conclusions are supported and informed by the present research but are not fully accomplished by this present work. Some sort of model repository could be beneficial to such ends. Such a repository could be expanded to be more inclusive by using the six dimensional interdependency framework of Rinaldi et al. (2001) or using a modified version of Griot's (2010) model assessment framework.

8.3.5. Conclusions about data

Two significant contributions were made in terms of data. First, 322 errors were identified in the CLARC Database which were corrected. Additionally, improvements to the CLARC Database were suggested and implemented in the creation of four separate databases. The BIIRM Multiplex dataset represents the CLARC Database restructured in a multi-plex fashion. The BIIRM Multiplex+ dataset incorporates the improvements suggested and adds additional telecommunication demand as well as an additional transportation commodity. The BIIRM Multiplex Reduced dataset is 10% of the BIIRM Multiplex dataset, while still maintaining the nodal and arc diversity. Finally, the BIIRM Multiplex Reduced+ dataset adds telecommunication and transportation demand proportionally based on the reduced instance size similar to the BIIRM Multiplex Reduced dataset. These latter two datasets are approximately the same size and scope of

military installations and represent a first attempt at creating military specific IIR datasets for academic research.

8.4. Recommendations for Future Research

The recommendations for future research are categorized in a similar fashion as the conclusions and contributions with the exclusion of literature review. Therefore, the following listed items are categorized as coupling, interdependencies, modeling, and data.

- Coupling
 - Explore more scenarios of overcoming inaccessible data. A critique in the review of one of the papers suggested it was limited by examining only one scenario.
 - Explore non-linear or complex coupling. These types of coupling comprise an under-explored area, since most assumptions assume tight and linear coupling characteristics and are normally node-to-node or arc-to-arc based.
 - Examine the time-delayed effects on system disruption based on loose coupling. Time-delayed effects are common in real systems due to on-site storage or some temporary capability to overcome outages. Common examples include uninterrupted power supply systems for critical electronic equipment. The inherent nature of the BIIRM can handle those peculiar relations, but they have not been explored.
- Interdependencies
 - Incorporate restoration interdependency resource competition in order to address common assumption of sufficient resources. This can be done in

part by adapting the general resource constraint presented by González et al. (2016).

- Incorporate degraded conditions such as chemical, biological, radiological, and nuclear (CBRN) protocol to recovery operations. This may include the identification of additional restoration interdependencies due to decontamination and post-attack reconnaissance.
- Address each characterizing assumption and combinations of assumptions. Efforts can build on others' work to share ideas about how to better model IIR nuances (e.g., increasing costs, shifting priorities).
- Modeling
 - Establish a model validation method by integration with Energy Resilience Readiness Exercises or “pull-the-plug” exercises performed across the Department of Defense. Additional integration can be achieved in general exercise planning and estimation of repair times and responses to scenarios based on simulation.
 - Integrate the BIIRM damage scenario simulation with HAZUS. This is coupled with additional GIS data improvements, but would provide a way to analyze likely damage scenarios and the impact of multi-plex structure for damage scenario creation.
 - Explore inherent model flexibility in additional ways to include non-static costs throughout recovery operations and shifting priorities. Explore additional scenarios such as a second wave of damage and incremental information flow.

- Examine time-based interdependencies, that materialize at moments of peak value. Moments of peak value is a novel approach to resilience-based analysis (Poulin and Kane 2021, under review).
- Develop heuristics and consider reformulation to improve BIIRM execution with larger instances. Current issues may be in the complex multilayer structure of multi-plex infrastructure layers within a multi-slice construct. This might be addressed by reevaluating a network flow and network design assumption which would allow arcs and commodities to cross infrastructure layers.
- Data
 - Correct the GIS interface based on the CLARC Database corrections.
 - Create a GIS interface for the BIIRM Multiplex datasets.
 - Create a GIS context and interface for the BIIRM Multiplex Reduced datasets and include military-specific nomenclature to asset types to better align with military base analysis.

These conclusions, contributions, and recommendations express the culmination of years of study in interdependent infrastructure recovery. The hope is this will profit the future development of efforts to improve the recoverability and thereby the resilience of civil infrastructures.

Appendix A. Network Database Preparation for BIIRM¹

This appendix details three main contributions to the preparation of the network database used for the BIIRM. The first section details the CLARC Database and slight corrections made based on the version available for download (Sharkey et al. 2018). The second section explains the modifications needed to convert that data into a multiplex layered system. The third section addresses the source and assumptions used to add cost data in lieu of real-world data from an actual damage event.

A.1. CLARC Database

The data used for the BIIRM was constructed largely from a database called the CustomizabLe ARTificial Community (CLARC) County Data (Little et al. 2020; Loggins et al. 2013). This database represents a mixture of real geospatial and infrastructure information of assets while removing proprietary or sensitive information. It was built over the course of a couple of years by the information from the data stewards and infrastructure managers. This database has significant advantages over other datasets primarily due to the multi-directional operational interdependencies rather than strictly defining dependencies on one infrastructure system (Sharkey et al. 2015). It also is representative of actual infrastructure data for a region (on the scale of a U.S. county).

These data represent 1,305 nodes across 10 infrastructures including: power, telecommunications, water, wastewater, transportation and emergency response (TER), travel, education, healthcare, industry, and residential. These nodes represent 47 different

¹ Some contents of this appendix were submitted independently as technical notes by Moore and Jacques to ASCE's *Journal of Infrastructure Systems* on 10 June, 2021. The submission was titled "Technical Notes on Using and Improving the CLARC Database for Interdependent Infrastructure Modeling and Simulation."

types of assets ranging from junctions in a power or water distribution system to power plants, schools, and other commercial entities. There are 4,764 arcs across 5 infrastructures including: power, telecommunications, water, wastewater, and TER. These arcs represent 21 different types of assets from bridges, interstates, and water mains to cell tower signals. It is noteworthy that the nodes are distributed across 10 layers and the arcs were categorized into 5 layers, but connected all the nodes using data fields of “To_Infra” and “From_Infra” representing the infrastructure layers in which the to- and from-nodes resided. Full descriptions are available with the original dataset (Sharkey et al. 2018). Table A1 summarizes the network attributes that are relevant.

Table A1. CLARC Database represents a large interdependent network consisting of nodes and arcs across five principal infrastructure systems (i.e., power, telecommunications, water, wastewater, and TER) and five additional layers

Infrastructure Type	Nodes		Arcs	
	Asset Types	Number	Assets Types	Number
Power	5	63	4	919
Telecommunications	2	29	5	414
Water	3	183	3	749
Wastewater	3	373	3	1169
TER	11	391	6	1513
Travel	4	52		
Education	5	41		
Healthcare	4	78		
Industry	9	18		
Residential	1	77		
Total	47	1305	21	4764

As mentioned previously, the CLARC Database exemplifies network-to-network interdependencies. This is evident with 2,631 interdependent relationships between various networks. The CLARC Database, for analysis of operational interdependencies,

grouped the node-based infrastructure networks of travel, education, healthcare, and industry as one aggregate layer called “Social” infrastructure. This resulted in a recategorization of node layers into seven layers consisting of the five principal infrastructure systems (i.e., power, telecommunications, water, wastewater, and TER), social, and residential layers to describe the interdependencies. Table A2 summarizes these operational interdependent relationships using these recategorized seven node-based infrastructure layers.

Table A2. CLARC Database exemplifies infrastructure interdependencies between all the network layers

Parent Infrastructure	Number of Child Infrastructures	Number of Relationships
Power	6	845
Water	5	423
Wastewater	5	425
Telecommunications	3	143
TER	3	795
Total		2,631

This summarizes the CLARC data, which served as the initial starting point for the databases used in the BIIRM. After the CLARC Database was downloaded some errors or inconsistencies in the data were noted and are addressed in the following subsection.

A.1.1. Correction of issues and irregularities

Data cleansing included identification of issues and irregularities and then correction of those errors consistent with the other data. The inconsistencies included missing demand, erroneous demand, mislabeling, missing location information, and arc inconsistencies.

A.1.1.1. Missing demand

One of eight wastewater treatment plants was missing a water demand. All others had a demand of 75, but Wastewater_Treatment_Plant_7 had a demand of 0. Five of 221 wastewater Pump_Stations were missing power demand, whereas all others had a power demand of 30. The pump stations were Pump_Station_61 and Pump_Station_208 to 211.

A.1.1.2. Erroneous demand

All 34 Banking ATM machines had both water and wastewater demands equal to 10. It is not clear why an ATM required a water or wastewater service connection and why they needed that demand met in order to fulfill their service as a monetary dispensary. Therefore, these demands at these nodes were set to zero and associated water and wastewater arcs were deleted.

A.1.1.3. Mislabeling

There were 107 lighted intersections out of 237 total intersections that each required power; however, there were only 77 arcs listed as a Power_Traffic_Line, indicating that 30 arcs were either missing or mislabeled. They were mislabeled under the “Definition” field as CF_Dist_Line, but properly labeled in the “Name” field. This change also resulted in a need to correct the capacity of the arc to size it consistent with the other Power_Traffic_Line arcs. The ArcIDs for these mislabeled arcs were: 1149, 1151, 1154, 1156, 1157, 1160, 1171, 1173, 1174, 1180, 1183, 1185, 1188, 1190, 1192, 1194, 1211, 1213, 1214, 1220, 1226, 1228, 1233, 1235, 1236, 1238, 4900, 4901, 4902, and 5478.

Three Water_to_CF lines were mislabeled as Waste_to_CF lines, confusing the definition and name. This was sorted out by observing which infrastructure they had a

listed capacity for. In all three instances they were water lines. These arcs had ArcID values of 3463 to 3465. Additionally, 10 Trans_CF_Conn arcs were mislabeled with the definition of “Local”, but should have had definition of “Trans_CF_Conn”. These were Trans_CF_Conn_272 to 281.

11 Waste_Main_Pipe arcs were inconsistently numbered, since all other arcs were paired in bi-directional groupings. This means arcs $(i, j): (9579, 9580)$ and $(i, j): (9580, 9579)$ would both be labeled as Waste_Main_Pipe_197. This nomenclature fell apart at Waste_Main_Pipe_366 and beyond, specifically involving Waste_Main_Pipe_366 to 377. There is also another Waste_Main_Pipe_380, which is discussed in the subsection addressing arc inconsistencies.

A.1.1.4. Missing locations

Many arcs were missing location information, which was under the field “Census_Tract”. There were 77 census tracts or locations. 100% of all the nodes and 96% of all the arcs had a specified location. It was chosen that the location of the point of destination would be the location of the arc. It is important to note that arcs can be in or transit more than one geographical location, which were considered as synonymous with the census tracts. Listing all transited locations of arcs would be an improvement upon the dataset and may support a more in-depth evaluation on the consequences of the restoration interdependency subtype of geospatial repair. In total there were 192 arcs without a listed census tract (location), with the following breakdown: 4 Power_Traffic_Line, 4 Main_Pipe, 1 Waste_Main_Pipe, 55 Trans_CF_Conn, 64 Waste_to_CF, and 64 Water_to_CF.

A.1.1.5. Arc inconsistencies

Each Census_Point had a duplicate connection with a Cell_Tower defined by the Signal arcs except for two Census_Points. Signal_83 and Signal_152 were the only connection from Cell_Towers to Census_Points_42 and 76 respectively.

Two duplicate bi-directional Trans_CF_Conn arcs existed, which connected node 149 to 5807. These arcs were Trans_CF_Conn_403 and 415 for arc $(i, j): (5807, 149)$ and Trans_CF_Conn_405 and 416 for arc $(i, j): (149, 5807)$. Due to the numbering Trans_CF_Conn_415 and 416 were deleted, since they represented the second instance of the same arc.

Waste_Main_Pipe_223 had an arc $(i, j) = (j, i): (9580, 9580)$, making it a bi-directional loop. However, in the GIS database the identified arc looked as if it should have been connected to node 9319, but both terminal points listed node 9580. In the database all Waste_Main_Pipe arcs were bi-directional, except Waste_Main_Pipe_380 which had an $(i, j): (9580, 9319)$ and no reciprocal arc. Therefore, it was determined that Waste_Main_Pipe_223 was intended to be the bi-directional set of arcs connecting nodes 9319 and 9580. This eliminated the need for Waste_Main_Pipe_380.

In summary, these errors were mostly minor, but serve as an improvement upon the original data set. In addition to these errors, some underlying concerns arose and are explained in the following subsection.

A.1.2. Concerns about the database

Two major concerns arose in reviewing the data and network structure as it pertained to the telecommunications infrastructure and the TER infrastructure. The telecommunications infrastructure is also called the information and communication

technology (ICT) infrastructure in some academic circles and is abbreviated as ICT in the present work (Oughton et al. 2016). The concerns were unique to each system and are expressed below.

A.1.2.1. Concerns with ICT infrastructure.

The largest concern was the apparent lack of connectivity to assets, which in day-to-day operations and in emergency situations rely heavily upon telecommunications. In fact, only four of the 47 different nodal asset types had a communication demand in the ICT network, namely: ATM, gas station, emergency communication center, and census points. After removing the two asset types that are within the ICT infrastructure and the four that originally had connectivity, there were 41 different nodal asset types that had no communication links. Of those 41 nodal asset types with no original ICT requirement, Table A3 lists 34 of them with examples of ICT services. Table A3 therefore represents the connectivity gap within the original CLARC Database.

Of particular interest to the present research is the presence of Supervisory Control and Data Acquisition (SCADA) systems, which are able to improve efficiency, but also create interdependencies and are sometimes vulnerable to system degradation (Bobbio et al. 2010). These relationships are primary sources of cyber interdependencies where dependence or control is based on the transfer of information through the ICT infrastructure (Rinaldi et al. 2001). One of the primary purposes of the BIIRM is to capture cyber as well as other operational interdependency subtypes simultaneously. Therefore, the absence of significant information in the ICT infrastructure is a concern.

Table A3. 34 nodal assets have day-to-day and emergency telecommunication requirements not captured in the original dataset

Node Asset Types	Information & Telecommunication Requirements
Airport	Air Traffic Control, radar, telephone, internet
Banking_Central_Office	ATMs, bank transactions, telephone, internet
Bus_Terminal	WIFI, telephone, internet
Central_Office	Telephone, internet
Child_Residential_Facility	Telephone, internet
College	WIFI, telephone, internet
EMS_Station	911 calls, dispatch, telephone, internet
Ferry	Telephone
Fire_Station	911 calls, dispatch, telephone, internet
Fuel_Terminal	SCADA ^a , telephone
Group_Home	Telephone, internet
Hospital	WIFI, dispatch, telephone, internet
Hotel	WIFI, telephone, internet
Industry ^b	SCADA, telephone, internet
Jail	Telephone, internet
Nursing_Home	Telephone, internet
Police_Station	911 calls, dispatch, telephone, internet
Pump_Station	SCADA
School ^c	Telephone, internet
Shelter	Telephone
Substation ^d	SCADA
Wastewater_Treatment_Plant	SCADA, telephone
Water_Treatment_Plant	SCADA, telephone
Well_Site	SCADA

^a SCADA – supervisory control and data acquisition; ^b Represents 8 different industries; ^c Represents 3 different school types; ^d Represents distribution and transmission types

Additionally, the layout and structure of the ICT network does not seem accurate or straight forward. There are two nodal asset types within the ICT network to include a central telephone office or hub and a cellular tower. Both types of nodes originally had a transshipment type function, which is an accurate representation of how they these types of nodes function in reality; however, it is not the only way to view these nodes. There is also an issue with the imbalance of the supply and demand nodes. The only supply nodes

are the census points (population nodes), which discounts any other asset type as an origin of a communication link (i.e., business-to-business, business-to-private transactions). It was intended to be modeled as a multicommodity flow of origin-destination (O-D) pairs also commonly done for telecommunication networks (Ahuja et al. 1993). In the CLARC Database there are 77 census points being the only supply of communication at a value of 1 each, and the network has a cumulative demand of 143. Due to the imbalance, it is impossible that all O-D pairs would have been successful in meeting the demand. Therefore, the structure and design of the ICT network was a concern both because of the lack of other O-D pair possibilities and the imbalance of supply and demand.

A.1.2.2. Concerns with the TER infrastructure.

While slightly less obvious, the TER infrastructure has an inherent disparity based on the multiple commodities flowing within that network. The TER infrastructure has three commodities which flow across the network and are the emergency services of “EMS”, “Police”, and “Fire”. While these are very important commodities in a response to and recovery from a disruptive event, there is a missing commodity of “People” that compete for the same transportation resources. In effect, by not modeling people or how the population moves from place to place in competition with the Emergency Response the TER network analysis is limited and only partially reflects recovery. People that need to be modeled include infrastructure work crews, workers for all the social and commercial entities modeled, and if necessary, based on the scenario (e.g., hurricane event), the excess population as it evacuates the area. The omission of “People” as a commodity in the TER network was also a concern.

The combination of these concerns prompted additions and modifications to the original CLARC Database in order to address these items of interest in the BIIRM. The details of these additions are explained in the following subsection.

A.1.3. Additions to the database

Additions or modifications were made to both the ICT and TER infrastructures in order to address the concerns mentioned above. Modifications to the ICT network included the identification of additional demand nodes, substitution of binary telecommunication demand with a range of demand, and a restructuring of the network to emphasize connectivity.

The 34 additional nodal asset types identified in Table A3 that have a day-to-day and emergency telecommunications demand were given a non-zero demand for a single type “Communications” commodity. Additionally, the original nodes that had a telecommunication demand equal to one were all given a non-zero demand scaled to represent either the number of working personnel at a given location or the demand for information exchange or some combination of the two.

In order to address the network structure concern, the ICT network was reconfigured to emphasize connectivity and ability to meet demand. Therefore, it was restructured as a supply and demand network flow versus the original O-D pairing. This was accomplished by turning the telephone central offices and cell towers into source nodes and then making all others demand nodes. This essentially allowed for an analysis of whether or not the demand nodes were connected via operable links to an ICT node, which then would connect to any other node via operable links. This allowed for identification of inoperable or damaged links or nodes that required repair and satisfied

the intent of ICT infrastructure analysis. Figure A1 illustrates the reconfiguration of the ICT network as a supply-demand network model to emphasize connectivity.

To address the concerns in the TER infrastructure every node was evaluated to determine if there was a need for a constant workforce. A constant workforce was defined as active laborers to perform the work or provide the service from that location. An example is a hospital requires doctors, nurses, and staff in order to provide the healthcare and life saving services they offer. In contrast to these types of nodes there are nodes like a distribution level substation, which houses electrical equipment, but is not manned constantly in order to provide the electrical service. Rather, if an issue arises, then a crew would be dispatched to that location. Such nodes were not considered as having a constant workforce and are therefore not demand nodes in terms of the commodity “People”. All nodes that have a constant workforce requirement were given a representative demand of commodity “People”. This then meant that during recovery of infrastructure and social services, the essential personnel or workforce were also included in the network analysis. Table A4 records the original and new “Communication” and “People” demands.

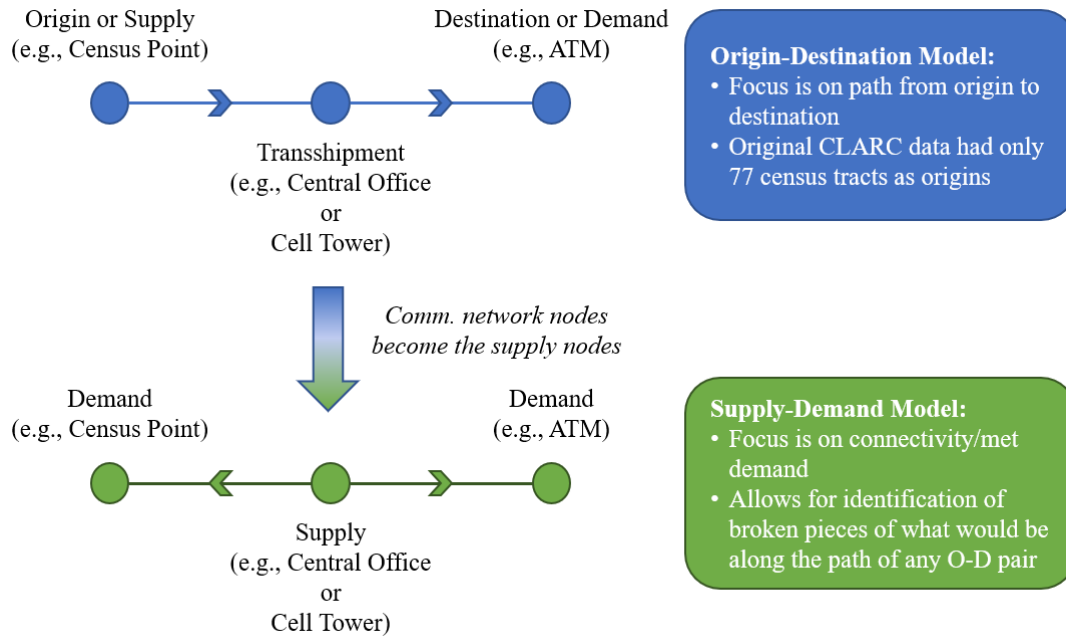

Fig. A1. Reconfiguring the ICT network in standard supply-demand construct emphasizes the connectivity and meeting demand of all demand nodes rather than focusing on the origin-destination path

Not captured in Table A4 is the supply data due to the changes in the ICT and TER infrastructure layers. The amount of supply of “People” at the population centers represent 65.4% of the total population at those locations, which is a national average percentage for those in the working age in the United States (OECD 2021). The supply quantity of “Communication” was scaled to meet the cumulative demand divided among the ICT nodes that were represented as supply nodes.

Table A4. Additional ICT & TER demand data required for BIIRM analysis

Infrastr.	Asset	"Communication"		"People"
		Orig.	New	New
PWR	Dist_Substation		1	
	Steam_Plant		10	10
	Trans_Substation		1	
WTR	Water_Treatment_Plant		5	5
	Well_Site		1	
WWT	Pump_Station		1	
	Wastewater_Treatment_Plant		5	5
TER	EMS_Station		10	10
	Fire_Station		24	25
	Police_Station		24	25
	Banking_ATM	1	1	
	Banking_Central_Office		10	10
	Fuel_Gas_Stations	1	5	5
	Fuel_Fuel_Terminals		5	5
	Hospital		95	100
Travel	Airport		475	500
	Bus_Terminal		5	5
	Ferry		5	5
	Hotel		10	10
Education	Jail		24	25
	School_High_School		48	50
	School_Middle_School		48	50
	School_Elementary_School		24	25
	College		475	500
Healthcare	Child_Residential_Facility		24	25
	Group_Home		24	25
	Shelter		5	5
	Nursing_Home		48	50
Industry	Emergency_Communication_Center	1	24	25
	Industry_Chemical_Plant		475	500
	Industry_Solar_Plant		475	500
	Industry_Battery_Plant		238	250
	Industry_Xray_Plant		238	250
	Industry_Distribution_Center		95	100
	Industry_Software_Company		48	50
	Industry_Steel_Company		95	100
Industry_Lumber_Yard		24	25	
Residential	Census_Point	1	500	

Another interesting complexity arose when within the TER infrastructure layer there were five nodal asset types that had both supply and demand type functions based on different commodities. While uncommon in network flow problems in general this is closer to reality, where within the transportation network a certain commodity must arrive before a different commodity may be sent out (e.g., replacement firefighting crews or replacement police officers must come on shift to take over for the others). These additions and modifications to the CLARC Database provide an overview of the changes to the data. In the next section the structure of the data is addressed.

A.2. Modifications of the Database for the BIIRM

This section outlines the modifications made in the structure of the CLARC Database in order to accommodate a multiplex structure where a node is mapped one-for-one in each network layer in which it is present (Bianconi 2018). This process entailed reconfiguring the data in the database to accommodate the multiplex structure. The restructuring of the data provided insights into operational interdependencies. Finally, this section will discuss the creation of a reduced dataset, the damage scenario data used for initial analysis with the BIIRM, and geospatial considerations.

A.2.1. Conversion of the database to a multiplex structure

The organization of the original CLARC Database made it difficult to use in a true multiplex sense and therefore it was restructured. One of the primary differences in the structure of the database can be understood by considering the nodes. A node in the CLARC Database was listed once, and then regardless of the various uses across infrastructures (i.e., supply, demand, capacity) all the node's data was on one row. In a multiplex database, each node has some parent infrastructure (i.e., power plant is in the

power infrastructure). This node may or may not be reflected into another infrastructure (i.e., power plant has a water and wastewater demand and therefore is reflected in those networks) and each instance of the node is a separate entry. This significantly increases the number of nodes, since the node may be represented in the case of the BIIRM on up to five different infrastructure layers. The number of arcs stays relatively the same under the assumption that a commodity flows only within its given infrastructure layer. An oversimplification of the process involves taking a fat and short data table and converting it into a skinny and tall data table.

Additionally, the original CLARC Database consists of nodes across 10 infrastructures and arcs across five infrastructures, which if used directly suggests that five infrastructure layers are disconnected or that arcs cross infrastructure boundaries. The latter was true for the original CLARC Database. Therefore, it was determined all nodes, including reflected nodes, and all arcs could be captured in just five infrastructure layers including: power (PWR), telecommunications or information and communication technology (ICT), water (WTR), wastewater (WWT), and transportation and emergency response (TER).

When reflecting nodes into the various infrastructures it was seen that only five infrastructure layers were needed. Table A5 maps the same five infrastructure layers used in the CLARC and BIIRM models. Table A6 maps the unique CLARC infrastructure layers to the BIIRM layers. These tables represent 47 different asset types and the nodes or reflected nodes across the infrastructure layers used in the BIIRM. In Tables A5 and A6, the indicator “H” represents the host infrastructure layer and the indicator “R” represents a reflected infrastructure layer.

A.2.2. Operational interdependency insights from multiplex construct

Organizing nodes in a multiplex manner provides an easy or visual way to determine whether or not some type of operational interdependency might exist between a node in a given infrastructure layer and that same node's reflection in another layer. This is possible by realizing that a node may have or will likely have a meaningful operational interdependency of the physical, cyber, and logical type when a given node performs more than one function across the various infrastructure layers it is reflected in.

In order to illustrate this, three scenarios are given. First, analyze the functions of a Fire Station across the various layers and one understands the Fire Station has a demand for power, communication, water, wastewater, and people. But that same Fire Station also supplies the emergency service of firefighting. Therefore, one can quickly see that due to the different functions across the various infrastructure layers there is the potential that one of the demand layers could impact that same node being able to respond to a fire or act as a supply node for the "Fire" service commodity. By employing engineering judgment or historical knowledge one can decide if there will be an interdependency between these sets of systems. For instance, no communication might inhibit the Fire Station from responding. Lack of personnel at the time of shift change might likewise impede or degrade responsiveness. While some of these things will not render a node inoperable or completely incapable of performing the other function, it is a starting point for assessment of how the various infrastructure services affect operations. This same pattern of evaluation is followed in the other two examples.

Table A5. CLARC node mapping to BIIRM infrastructure layers and commodities; H – host layer, R – reflected layer

CLARC Infra.	Node Asset Type	<u>PWR</u>	<u>ICT</u>	<u>WTR</u>	<u>WWT</u>	<u>TER</u>			
		Power	Comm	Water	Waste	EMS	Police	Fire	People
Power (PWR)	Dist_/Trans_Substation	H	R						
	External_Demand	H							
	Power_Node	H							
	Steam_Plant	H	R	R	R				R
Telecommunications (ICT)	Cell_Tower	R	H						
	Central_Office	R	H						
Water (WTR)	Water_Node			H					
	Water_Treatment_Plant	R	R	H	R				R
	Well_Site	R	R	H					
Wastewater (WWT)	Pump_Station	R	R		H				
	Waste_Node				H				
	Wastewater_Treatment_Plant	R	R	R	H				R
Transportation, Emergency Response (TER)	Banking_ATM	R	R						
	Banking_Central_Office	R	R	R	R		H		H
	EMS_Station	R	R	R	R	H			H
	Fire_Station	R	R	R	R			H	H
	Fuel_Fuel_Terminals	R	R	R	R	H	H	H	H
	Fuel_Gas_Stations	R	R	R	R				H
	Hospital	R	R	R	R	H	H		H
	Intersection					H	H	H	H
	Intersection_Lighted	R				H	H	H	H
	Police_Rally_Point						H		
Police_Station	R	R	R	R		H		H	

196

Table A6. CLARC non-primary node mapping to BIIRM infrastructure layers; H – host layer, R – reflected layer

CLARC Infra.	Node Asset Type	<u>PWR</u>	<u>ICT</u>	<u>WTR</u>	<u>WWT</u>	EMS	<u>TER</u>		
		Power	Comm	Water	Waste		Police	Fire	People
Travel	Airport	R	R	R	R	H	H	H	H
	Bus_Terminal	R	R	R	R	H	H	H	H
	Ferry	R	R	R	R	H	H	H	H
	Hotel	R	R	R	R	H	H	H	H
Education	College	R	R	R	R	H	H	H	H
	Jail	R	R	R	R	H	H	H	H
	School_Elementary/_Middle/_High	R	R	R	R	H	H	H	H
Healthcare	Child_Residential_Facility	R	R	R	R	H	H	H	H
	Group_Home	R	R	R	R	H	H	H	H
	Nursing_Home	R	R	R	R	H	H	H	H
	Shelter	R	R	R	R	H	H	H	H
Industry	Emergency_Communication_Center	R	R	R	R			H	H
	Industry_Battery_Plant	R	R	R	R	H	H	H	H
	Industry_Chemical_Plant	R	R	R	R	H	H	H	H
	Industry_Distribution_Center	R	R	R	R	H	H	H	H
	Industry_Lumber_Yard	R	R	R	R	H	H	H	H
	Industry_Software_Company	R	R	R	R	H	H	H	H
	Industry_Solar_Plant	R	R	R	R	H	H	H	H
	Industry_Steel_Company	R	R	R	R	H	H	H	H
Industry_Xray_Plant	R	R	R	R	H	H	H	H	
Residential	Census_Point	R	R	R	R	H	H	H	H

Second, a pump station functions as a transshipment node in the wastewater infrastructure layer, but has a power demand and is controlled by a SCADA system in the ICT infrastructure layer. Therefore, it is possible that the power or the SCADA system could impact the operability of the pump station within the wastewater network thereby creating an operational interdependency of the physical or cyber type.

Third, an airport has demand across all five of the infrastructure networks examined. Therefore, if demand is not met by one or more infrastructure service there is no service with an associated alternate nodal function that is being evaluated that would be impacted by unmet demand. In reality, an airport provides travel by air, but if that is not being modeled then that won't be considered as some operational interdependency. These scenarios are visually seen in Figure A2 where red indicates a demand, yellow a transshipment, and green a supply function.

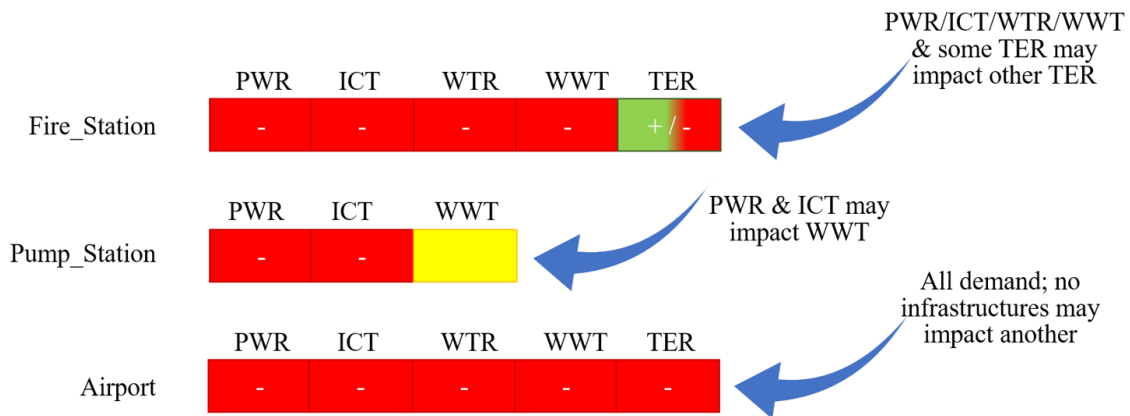

Fig. A2. Use of color coding for demand (red), transshipment (yellow), or supply (green) function provides visual method for understanding whether or not operational interdependencies are likely

While this is not a primary reason for structuring the database in this fashion, it does help answer infrastructure managers' and researchers' consternation of having elusive operational interdependencies (Ouyang 2014). The restructuring of the CLARC Database also provided a multiplex structure of the original data intended for analysis in the BIIRM. This newly structured database without the additions of new communications connections and people mentioned is called the BIIRM Multiplex dataset. The dataset with the ICT and TER additions is called the BIIRM Multiplex Plus dataset. Additional modifications are explained in the following subsection.

A.2.3. Reduced dataset for base-level scope

One of the primary objectives of the BIIRM was to analyze interdependent infrastructure recovery as it relates to a military base. While the diversity of support operations on a military installation are similar to the CLARC Database, the size is substantially smaller than a regional size database. Therefore, a 10% sampling of all asset types within the CLARC Database provides an approximation of the diversity and quantity of infrastructure on a medium- to large-sized military installation. Such a sampling produced a reduced dataset called the BIIRM Multiplex Reduced dataset. This reduced dataset has a companion which includes proportional ICT and TER additions and is called the BIIRM Multiplex Reduced Plus dataset.

In the BIIRM Multiplex Reduced dataset there were at least one of all the 47 different types of nodal assets and all 21 arc assets included. Table A7 provides a brief summary and comparison between the CLARC Database, the BIIRM Multiplex dataset (MP), the BIIRM Multiplex Plus dataset (MP+), the BIIRM Multiplex Reduced dataset

(MPR), and the BIIRM Multiplex Reduced Plus dataset (MPR+) with key network elements.

Table A7. Multiplex structure adds significant node count as seen in comparison of CLARC, BIIRM Multiplex (MP), Multiplex Plus (MP+), Multiplex Reduced (MPR), and Multiplex Reduced Plus (MPR+) datasets

	CLARC	MP	MP+	MPR	MPR+
Nodes	1305	1305	1305	153	153
Reflected Nodes	0	1715	2366	227	312
Arcs	4764	4761	4761	648	648
Additional Arcs		19	1302	2	176

The additional arcs in the BIIRM Multiplex dataset are due to 19 electrical generator lines for 19 cell towers, which were incorporated into the analysis done by Sharkey et al. (2015). Similarly, the 2 additional arcs in the BIIRM Multiplex Reduced dataset are 2 electrical generator lines. The other additional arcs in the BIIRM Multiplex Plus and BIIRM Multiplex Reduced Plus datasets are the necessary arcs to satisfy the increased demands in the ICT and TER infrastructure layers. The compilation of the damage scenario data is expressed in the next subsection.

A.2.4. Damage scenario data

The damage scenario was created to mirror the magnitude of damage scenarios found in literature, specifically the damage scenarios of Sharkey et al. (2015). The damage scenarios simulated by Sharkey et al. (2015) were chosen due to the use of the CLARC Database as a starting point and the authors' inclusion of restoration interdependencies. The original intent was to use the results of Sharkey et al. (2015) as a benchmark and calibration point against the BIIRM. However, details regarding the exact

damage scenario and all data associated with the network were not available. Therefore, it served as a target magnitude of a damage scenario. Across the three damage scenarios performed by Sharkey et al. (2015), 3% of nodes and 6% of arcs were damaged on average. That became the target values for the created damage scenario used for the BIIRM. While these values were the target values, damage is scenario specific and shouldn't preclude analysis with varying levels of damage.

The main reason the damage scenario was created was there hasn't been a simulated damage event which allowed for the evaluation of all nine interdependency types simultaneously. However, real-world scenarios often include these types of interdependencies affecting operations or restoration (Ouyang 2014). Therefore, to ensure realistic scenarios, the damage scenario was created to showcase the cause and effect of including operational and restoration interdependencies.

It should be noted, in an actual damage scenario information will come in sporadically and will be unique to the disruptive event. Some operational interdependencies will be known prior to a disruptive event and as mentioned above, some analysis may identify additional operational interdependencies. History has shown that time and again we will also be surprised by some unknown operational interdependencies (Matthews 2005; National Infrastructure Advisory Council (NIAC) 2018). Restoration interdependencies are inherently situation-specific; however, there may be historical instances which drive local protocol that can be construed as pre-determined restoration interdependencies, especially if these protocols affect the precedence of recovery. Such protocol-driven scenarios can be pre-programmed into the restoration interdependencies of given infrastructure systems within the model. These

pre-programmed interdependencies can be given conditional coding that will generate precedence constraints only if both assets within the interdependent infrastructure systems are damaged. This was tested during model debugging of the base model; however, it is not likely that most of the restoration interdependencies would come from this type of protocol-driven origin. Therefore, in this scenario each component of the restoration interdependency was damaged and precedence was relayed through the command structure to develop the restoration interdependencies.

An anecdote helps illustrate how restoration interdependencies might be established during a damage assessment following some disruptive event. For instance, a city crew is dispatched after a major storm and notes that trees had been knocked down and are lying on some power lines. This is called in to a disaster management center and is a task for the city crew to clean up, but requires an electrical crew to ensure everything is de-energized prior to tree removal. Following tree removal, the electrical crew will need to repair the power line and re-energize the system. This type of damage report should establish precedence relationships (restoration interdependencies) which will inform calculations of system recovery times.

The completeness of the damage scenario in terms of restoration interdependency subtypes is illustrated by comparison. Table A8 compares the damage inclusion of restoration interdependency subtypes by Sharkey et al.'s (2015) work and the BIIRM MP+ dataset. Additionally, the BIIRM MPR and MPR+ datasets also had damage scenarios that leveraged all restoration interdependency subtypes. In the case of the traditional precedence relationships the BIIRM MP+ is double the number of relationships used by Sharkey et al. due to counting both directions of bi-directional arcs.

Table A8. Damage scenario created for the BIIRM Multiplex Plus dataset is the only one incorporating all restoration interdependency subtypes of interest

Interdependency Type	Infrastructures	Sharkey et al., 2015 ^a		BIIRM MP+
		Med.-Scale	Lrg.-Scale	
Traditional Precedence	PWR & TER	1	10	20
	TER & PWR	1	10	20
Effectiveness Precedence	PWR & TER	0	0	80
Options Precedence	TER & WTR	0	0	56
Time-sensitive Options	PWR & ICT	19	19	57
	PWR & WWT	52	52	52
Geospatial Repair	All	0	0	77

This tailored damage scenario also highlights the variety of coupling possibilities within restoration interdependencies. There are four coupling strategies for these types of relationships, namely: node-to-node, node-to-arc, arc-to-node, and arc-to-arc. Table A9 shows that the damage scenario utilizes all four coupling strategies possible for the restoration interdependencies.

Table A9. BIIRM damage scenario showcases all four coupling strategies possible in restoration interdependencies

Interdependency Type	Coupling Strategy
Traditional Precedence	arc-to-arc
Effectiveness Precedence	node-to-arc
Options Precedence	arc-to-node
Time-sensitive Options	node-to-node
Geospatial Repair	n/a

An alternate damage scenario creation mechanism was explored, but not fully exercised. If a fully developed GIS representation of the BIIRM Multiplex dataset had been available or created (see next subsection), then damage could be simulated using an

ArcGIS plugin like HAZUS, developed by Federal Emergency Management Agency. Unfortunately, this was not accomplished in the present work and is an area of improvement for future work. In combination with the HAZUS damage simulation, the use of stochastics for associating a probability of damage to certain asset types across the various infrastructure layers might be able to generate more robust damage scenario profiles to test overall system response.

A.2.5. Geospatial considerations

The original CLARC Database consisted of some geospatial information, which allowed for the nodes, arcs, and census tract polygons to be loaded into ArcMAP. All the nodes and arcs were included in one shape file and needed to be parsed into each individual infrastructure layer to support either the original CLARC “layers” or the BIIRM multiplex structure. This effort was started; however, missing data, mislabeled data, as well as disconnected components of the network slowed the data transformation. This problem was exacerbated by trying to turn the original CLARC GIS data into a GIS representation of the BIIRM Multiplex. The final issue became the missing portion of the ICT network which was deemed as critical information. Therefore, attempts to correct and add missing GIS information was abandoned for the present work and the effort was shifted to only the node and arc information in the databases.

The BIIRM Multiplex Reduced network represents an approximate 10% sampling of the CLARC Database constructed in a multiplex fashion. This reduced dataset was given a geospatial context in order to inform the damage scenario creation and also the associated interdependencies. This geospatial context allowed for a simulated damage

event to consider geospatial operational interdependencies by having some reference of proximity.

Future work can address GIS compatibility with the changes mentioned above. This is an area where significant improvements can be made in terms of data visualization and synchronization with other GIS tools and analysis. While not the focus of the present research, some efforts were made to incorporate aspects of geospatial context in order to fully evaluate the operational interdependency geospatial subtype.

The following section explains the largest contribution to the primary data, by adding cost figures to the data.

A.3. Addition of Cost Data

The CLARC Database had no cost data associated with it, which presented a concern, since the most common objective functions in interdependent infrastructure recovery analysis were cost-centric. Therefore, generic cost data was constructed for all the various asset types and all other associated costs used in the cost objective of the BIIRM. These costs include site preparation, repair, assignment, and flow costs. These are each given an individual subsection below. Additionally, penalty costs are discussed since they were used intermittently throughout the model for various reasons.

As a general note, actual cost data associated with an actual network would be superior to any cost data created. While the creation or fabrication of the cost data is not flawless, extensive efforts were employed to render a representative cost structure. The resulting cost data are flexible and responsive to varying types of analyses of interest to the research based on tailorable assumptions on the amount of damage, unit costs, etc. It is important to remember much of the cost data related to infrastructure may be

proprietary or protected and therefore representative costs may be all that is publicly accessible for research.

The purpose in creating cost data for the CLARC Database and associated BIIRM datasets is to more fully understand the multi-objective behavior of infrastructure recovery and to provide a proof of concept. At best these costs should be considered as project comparison cost estimates with no greater accuracy than -20% to $+40\%$ (DoD 2010). The following subsections explain how each of the different types of cost were created.

A.3.1. Site preparation costs

The CLARC Database had four different terrain types including: open, heavy trees, city, and suburbs. Each of these areas were used in order to establish the cost of site preparation. While each repair project in reality might have unique site preparation costs and unique requirements, these four terrain types were assumed to be unique enough to apply a single cost for work within a geospatial area. The CLARC Database had 77 geospatial sites called Census Tracts, which were the same for the BIIRM Multiplex datasets, and which were reduced to 8 Census Tracts for the BIIRM Multiplex Reduced datasets. Three different websites were consulted to determine price ranges for site preparation within the various terrain types (homeadvisor.com 2021a; howmuch.net 2020; kompareit.com 2021). Table A10 shows the costs for site prep for work within the four various terrain types.

Table A10. The four terrain types used in CLARC Database have site preparation costs

ranging from \$1,000 per job to \$3,500 per job

Terrain Type	Site Prep Cost
Open	\$1,000
City	\$2,750
Heavy Trees	\$3,500
Suburbs	\$1,750

A.3.2. Repair costs

Each of the 68 different asset types found in the CLARC Database were given a unique cost using Table 3 of Unified Facility Criteria (UFC) 3-701-01, *DoD Facilities Pricing Guide, with change 6*. Each asset type was compared with the Facility Analysis Category (FAC) within the DoD Real Property Classification System and the respective FAC title. A Plant Replacement Value (PRV) is given for each FAC, where PRV is defined as the “cost to design and rebuild a notional facility to current standards [in order] to replace an existing facility on the same site” (DoD 2020). This was considered as what was required in the case of catastrophic failure or total damage of the assets.

Using the chosen FAC for each asset, Table 3 of the above-mentioned UFC provides a PRV Unit Cost (PUC). The PUC in combination with a reference size or asset quantity (completely tailorable) were used to obtain the total cost of an asset (see Equation A.1).

$$Total\ Cost\ of\ Asset = PUC \times Quantity. \quad (A.1)$$

The total cost of an asset was then split into an appropriate number of portions based on the number of infrastructure systems affecting that asset plus one. For example,

a lighted traffic intersection has a transportation (TER) and electric (PWR) aspect to this asset. Therefore, the total cost of repair for that intersection was divided into 2+1 equal portions. The “lead” or “host” infrastructure system received a double portion of the cost and the reflected aspects of that node received only one. Another example takes an airport, which has a demand in all five infrastructure layers, and divides the total cost into six equal portions. In this instance the double portion is also associated with the TER infrastructure layer since that is the “host” layer for that node. Equations A.2 and A.3 represent the cost per asset system and the cost for the lead asset system respectively.

$$\text{Cost per Asset System} = \frac{\text{Total Cost of Asset}}{(\text{Number of layers}+1)} \quad (\text{A.2})$$

$$\text{Cost per Lead Asset System} = 2 \times \text{Cost per Asset System} \quad (\text{A.3})$$

The costs of the asset systems were then used to determine the cost of the damage to that asset system, based on an assumed percentage of damage. The percentage of damage is completely tailorable, to include variations within different systems, based on the damage scenario. The percentages used in the BIIRM Multiplex and BIIRM Multiplex Reduced datasets ranged from < 1% to 100% based on the expendability of the asset systems. Only the Census_Point assets had damage less than 1%. This was determined because it was assumed that the cost to a community would be far less than the cost to private owners and their insurance companies for reparation. Equation A.4 shows how the cost of a damaged asset system was calculated. Equation A.4 also applies to the lead system.

$$\text{Cost of Damaged Asset System} = \text{Cost of Asset System} \times \text{Damage}. \quad (\text{A.4})$$

All UFC cost data reflected FY2020 dollars and was not adjusted any further, being considered present value. Again, it is reiterated that actual cost data would be of greater and of a more valuable quality to a user of the BIIRM, but in the absence of that data this offers a realistic tailorable cost based on the assumptions a user imposes to develop the cost of repair for damaged assets.

A.3.3. Assignment costs

It is assumed in the BIIRM that each infrastructure layer has fully trained and equipped craftsmen associated with that network to fix any of the problems associated with damaged assets within that layer. This means that parallel work crews can be developed for each layer similar to other work in this research field (Cavdaroglu et al. 2013; Nurre et al. 2012; Sharkey et al. 2015).

Assignment costs were developed for work crews that would repair various infrastructure assets within a given infrastructure system. While these costs are representative, actual shop rates or employee wages for given recovery crews can be substituted if available. Hourly rates were found on a variety of sites ranging from \$15 to \$200 per hour (homeadvisor.com 2021b; c; payscale.com 2021a; b). Table A11 lists all the assignment costs based on an assumption of three-person crews for 8 hours using average hourly rates.

Table A11. Assignment costs for the five infrastructure systems used in the BIIRM range from \$600 to \$2,520 per work crew assignment

Infrastructure	Hourly Rate	Daily Rate ^a
PWR	\$75	\$1,800
WWT	\$105	\$2,520
WTR	\$105	\$2,520
ICT	\$25	\$600
TER	\$25	\$600

^a Based on 3-person crew for an 8-hour work day

A.3.4. Flow costs

The first challenge in assigning flow costs was having to deal with unitless demand values in the CLARC Database. Various nodal asset types within the CLARC Database had a relative scale in terms of supply or demand of a given commodity. For example, the commodity of “Power” varied across the demand nodes from 5 for a lighted traffic light to 500 for a census point housing tens of thousands of residents. Each commodity within a network was unitless with some relative scale.

These relative scales within the CLARC Database did not perfectly match values for similar types of facilities from national databases. However, in most instances each commodity’s relative scale roughly followed actual data in terms of magnitude. For example, the power usage over a month for residential dwellings was approximately 914 kWh, where commercial entities used on average 6,189 kWh, and industry used 99,221 kWh on average (U.S. Energy Information Administration (EIA) 2020). This approaches a near tenfold increase across these different sectors and when converted to kWh per day the values nearly matched those assigned in the CLARC Database. Therefore, the units

assigned to the supply and demand for the power infrastructure was kWh/day. A similar analysis was completed for all the infrastructure networks. Table A12 shows the results including the range of values from the BIIRM Multiplex Plus dataset for demand and the assigned unit of measure.

Table A12. Relative nodal demand scales and units of measure based on commodity

Infrastructure	Relative Demand Scale	Units Assigned
PWR	5 to 500	kWh/day
ICT	1 to 500	peak connections
WTR	10 to 120	kGal/day
WWT	10 to 120	kGal/day
TER	2 to 20 (EMS)	calls/day
	2 to 30 (Police)	calls/day
	2 to 15 (Fire)	calls/day
	5 to 500 (People)	commutes/day

Establishing units of measure allowed for investigation into the average cost of providing utility services. It was assumed that utility companies owned and operated by a municipal are compensated for expenditures to include operations and maintenance, but are not necessarily for-profit enterprises. While some public services are for-profit and are structured more like businesses, it was assumed that the costs associated with utility payment represents the cost to flow materials to customers. The identification of unit cost of the commodity did not fix correlating the CLARC or BIIRM relative demand scale to actual demands.

Correlation of the CLARC or BIIRM relative scale and real values from national databases presented a further challenge. The main way the relative scale was applied to the national database figures was by using a percent deviation of the mid-range. This permits the use of the relative scale inherent in the CLARC Database and BIIRM

datasets, while still being able to associate it with the real cost data. This strategy will be shown in certain instances and contrasted against other methods used for certain commodities. In general, some infrastructure systems shared commonalities, while each infrastructure network displayed some uniqueness.

Power, water, and wastewater. The U.S. Energy Information Administration (2020) publishes an annual report with cumulative energy sales, customers, and prices. While this report encompasses various forms of energy generation, the averages were used to establish the cost for three different sectors including: residential, commercial, and industrial. The cost for each sector was found by taking the 2019 “Sales to Ultimate Customers” (Table 2.2 in reference) and dividing it by the 2019 “Number of Ultimate Customers” (Table 2.1 in reference). This was then converted to kWh/day and multiplied by the 2019 “Average Price” (Table 2.4 in reference) to achieve a cost for each of the three sectors in \$/kWh.

The Department of Energy produced a report in 2017 with quantities, prices, and trends of water and wastewater data from 2008 to 2016 (U.S. Department of Energy 2017). The water consumption data (Table 1 in reference) were used to develop sector averages for water consumption and wastewater production across the three sectors of residential, commercial, industrial. Additionally, the data from the water rates (Figure 3 in reference) and wastewater rates (Figure 4 in reference) over time were used to find the price for water delivery and wastewater treatment in FY2020 dollars. This was accomplished by using the trends identified in the report.

Table A13 shows the relative demand range for the CLARC and BIIRM datasets within a given sector, excluding the census points from the residential ranges. The census

points used in the CLARC Database and BIIRM datasets are unique in that they are a single node which represents a cluster of similar type facilities (called cluster nodes). Due to their unique nature, they are treated separately in calculating the flow cost to those particular nodes. Table A13 also displays the average demand based on national databases and the associated unit cost per sector.

Table A13. Model demand ranges, average national demand [units/time], and average unit cost [\$/units] vary across infrastructures and asset sector grouping

Sector	PWR	WTR	WWT
Residential	50 to 75 ^a	10 to 15 ^b	10 to 15 ^b
	30 kWh/d	0.37 kGal/d	0.49 kGal/d
	0.1301 \$/kWh	3.89 \$/kGal	5.07 \$/kGal
Commercial	20 to 500	50 to 50	5 to 50
	202 kWh/d	6.61 kGal/d	8.61 kGal/d
	0.1068 \$/kWh	3.89 \$/kGal	5.07 \$/kGal
Industrial	0 to 500	0 to 75	0 to 50
	2,918 kWh/d	211.93 kGal/d	276.22 kGal/d
	0.0681 \$/kWh	3.89 \$/kGal	5.07 \$/kGal

^a Census tracts have a power relative demand of 500.

^b Census tracts have a water and wastewater relative demand of 120.

These average costs were then converted into a representative unit flow cost for the model using one of two general equations. Equation A.5 represents the general conversion equation for the census tracts (cluster nodes). The unit prices are converted into a unit flow cost, c_{ijt}^k , based on the number of units or dwellings represented by node $j \in \mathcal{N}_D^k$ in the CLARC or BIIRM datasets. The conversion is achieved by taking the average usage for a given sector, multiplied by the number of facilities represented by a node, multiplied by the average cost, all divided by the “To_Node” usage or b_{jt}^k , where

$j \in (i, j)$. Equation A.6 represents the second general equation for non-cluster nodes. The only difference between Equations A.5 and A.6 is the substitution of “number of facilities” with a percent deviation from the mid-range, which is an expression of central tendency that can be utilized to leverage the relative demand scale in the CLARC and BIIRM datasets.

$$c_{ijlt}^k \left[\frac{\$}{\text{units} \cdot \text{day}} \right] = \frac{\text{Avg Usage} \left[\frac{\text{units}}{\text{day} \cdot \text{facility}} \right] \times \text{Qty} \left[\frac{\text{facility}}{\text{node}} \right] \times \text{Avg Cost} \left[\frac{\$}{\text{units}} \right]}{\text{To Node Usage} \left[\frac{\text{units}}{\text{node}} \right]}. \quad (\text{A.5})$$

$$c_{ijlt}^k \left[\frac{\$}{\text{units} \cdot \text{day}} \right] = \frac{\text{Avg Usage} \left[\frac{\text{units}}{\text{day} \cdot \text{node}} \right] \times \left(1 + \frac{(b_{jlt}^k - \bar{b}_{lt}^k)}{\max_{j \in \mathcal{N}_D^k} b_{jlt}^k - \min_{j \in \mathcal{N}_D^k} b_{jlt}^k} \right) \times \text{Avg Cost} \left[\frac{\$}{\text{units}} \right]}{\text{To Node Usage} \left[\frac{\text{units}}{\text{node}} \right]}, \quad (\text{A.6})$$

where, \bar{b}_{lt}^k represents the mid-range value of the model demand scale for a given commodity $l \in \mathcal{L}^k$ within an infrastructure $k \in \mathcal{K}$ at a time period $t \in \mathcal{T}$. The mid-range value is calculated using Equation A.7.

$$\bar{b}_{lt}^k = \frac{\left(\max_{i \in \mathcal{N}_D^k} b_{ilt}^k + \min_{i \in \mathcal{N}_D^k} b_{ilt}^k \right)}{2}, \quad \forall l \in \mathcal{L}^k, k \in \mathcal{K}, t \in \mathcal{T}. \quad (\text{A.7})$$

An example calculation for a residential arc between nodes 2501 and 5001 is shown in Equation A.8. Where node 2501 represents a transmission substation and node 5001 represents a census point (concentration of individual residential dwellings), with the commodity being “Power” and the time period being $t1$. The high price of delivering electricity to this one node is due to the fact that the census points represent a collection of residential facilities, and in this particular case supporting over 19,000 people. In essence, the census points tend to reduce the quantity of similar, co-located facilities together into one node in order to reduce the overall number of nodes.

$$C_{2501,5001,Power,t1}^{PWR} = \frac{30 \left[\frac{kWh}{d.residence} \right] \times 5619 \left[\frac{residence}{node_{5001}} \right] \times 0.1301 \left[\frac{\$}{kWh} \right]}{500 \left[\frac{kWh}{node_{5001}} \right]} = 43.25 \left[\frac{\$}{kWh \cdot d} \right]. \quad (A.8)$$

Additionally, an example calculation for an industrial arc between nodes 6001 and 5761 is shown in Equation A.9. Where node 6001 represents a power node and node 5761 represents a solar panel plant. In this instance the demand value is 500 in a scale 0 to 500 with a mid-range value of 250 for node 5761. Therefore, the overall cost to flow power is less to the single industrial node versus the aggregate residential node.

$$C_{6001,5761,Power,t1}^{PWR} = \frac{2918 \left[\frac{kWh}{d.node_{5761}} \right] \times \left(1 + \frac{(500-250)}{500} \right) \times 0.0681 \left[\frac{\$}{kWh} \right]}{500 \left[\frac{kWh}{node_{5761}} \right]} = 0.60 \left[\frac{\$}{kWh \cdot d} \right]. \quad (A.9)$$

These general equations and examples provide an illustration of how unit cost flows were developed for power, water, and wastewater infrastructures.

Telecommunications. The BIIRM seeks to increase the focus of the telecommunication connections and requirements across multiple assets throughout the dataset. This is achieved by providing updated values to the communications demand, which roughly equates to 95% of the working population at a given node based on the average percentage connectedness across the U.S. (Pew Research Center 2019). While it is unlikely that a single entity will be making 500 telephone calls in any one given point in time, 500 was chosen as the upper range of the demand used in the BIIRM commensurate with other commodities. This demand value can be considered as a combination of the following types of connections: telephone, cellular, internet, and industrial control systems. Only one generic commodity called “Communication” is used, when in reality there could be multiple for each of the above-mentioned ICT connection

types. This means that in developing the flow cost both internet/data and telephone/cellular prices were considered.

For census points cellular prices were used based on costs ranging from \$70 to \$114/customer/month (Akhtar 2021; Webber 2019), which had an average of \$92/customer/month. These prices seem to reflect both customers with and without multiple lines, but are used to reflect a household (Webber 2019). Residential internet average price is \$60/household/month (Dilley 2021). These two costs sum to be \$3.65/household/d. By using Equation A.5 above, a unit cost can be calculated for census tracts.

For commercial, industrial, and the remaining residential facilities corporate telephone prices were used based on an average cost of \$25/user/month (Dinardi 2019). Corporate internet prices depended on what level of data was needed ranging from \$70/facility/month to \$500/facility/month, with an average over the top four internet packages being \$375/facility/month (Frost 2020). This translates to a commercial/industrial base cost of \$12.50/facility/day plus a variable cost of \$0.83/person/day. This is a straight forward unit cost, which is expressed in Equation A.10, where $l \in \mathcal{L}^k$ is “Communications” and $k \in \mathcal{K}$ is the ICT infrastructure.

$$c_{ij(Comm)t}^{ICT} = \frac{12.50 + (0.83b_{j(Comm)t}^{ICT})}{b_{j(Comm)t}^{ICT}}, \quad \forall (i, j) \in \mathcal{A}^{ICT}, t \in \mathcal{T}. \quad (\text{A.10})$$

Transportation and emergency response. There are various methods used to determine cost of vehicular traffic in terms of wear and tear on the road surfaces. Most experts claim that weight is one of the largest factors determining damage to road surfaces; however, there are lots of hidden costs and lots of complications. An

organization out of Canada published an article that seeks to define the cost to society of a 5 km commute (McLaren et al. 2015). While not perfect, this serves as the basis of the cost, which is then multiplied by how heavy the vehicle is that is driving on the road as compared to the standard automobile. The cost was converted from 2.78 2015 Canadian dollars per 5 km to 0.014¢ per linear foot of road traveled per vehicle. This unit price is then multiplied by the distance of each road to develop unique costs per vehicle for each TER arc for all the commodities. Table A14 shows the summary of the unit costs for each of the commodities within the TER network.

Table A14. Unit costs for TER commodities based on weight

Commodity	Vehicle Weight (lbs)	Weight Multiplier	Unit Cost (\$/LF/vehicle)
People	4000	1	0.00014
Police	4500	1.125	0.00016
EMS	12000	3	0.00043
Fire	50000	12.5	0.00181

A.3.4. Penalty costs

Penalty costs were used in some of the initial model formulations, but were eventually removed. The primary reason penalty costs were included was to incentivize flow in a minimum cost of recovery scenario. With a damaged network, traditional network flow may be disrupted leaving some nodes with unmet demand or a surplus supply due to an inability to deliver the commodities to the demand nodes. This changes the steady state network minimum cost flow problem to an inherently different problem. With a minimizing objective function on cost and the allowance of unmet demand and surplus supply the easiest way to minimize cost in terms of flow is to not flow any commodities throughout the network. Penalty costs were used to incentivize flow and

penalize unmet demand that could be met due to an operating network as seen in other work (Gonzalez 2017; González et al. 2016).

Penalty costs were removed for two primary reasons, namely the addition of competing objectives and the inherent challenges with proper scaling. When the BIIRM was originally built it was seeking least cost recovery strategies. In this scenario with no other competing objective and due to a damaged network, penalty costs were essential to incentivize flow. However, the addition of other competing objectives eliminated the need of penalty costs. This was a welcome thing since penalty costs must be appropriately calibrated to not overly skew a model because they are too large or be overlooked by the model because they are negligible (González et al. 2016). While penalty costs have some utility, they were abandoned in light of competing objectives.

A.4. Summary of Changes

This appendix has detailed the issues that were found in the CLARC Database. It also listed the concerns with missing data and network structure issues within the ICT infrastructure network. The appendix also detailed how the CLARC Database was reconfigured into a multiplex construct. This resulted in a significant increase in the number of nodes used in the BIIRM datasets. Finally, this appendix detailed the addition of cost data and explained which aspects of the data are tailorable.

These changes are included to summarize notes, assumptions, and decisions regarding the preparation of the BIIRM datasets used in the foregoing research.

Appendix B. Interdependent Infrastructure Recovery Model Reviews

This appendix details the interdependent infrastructure recovery (IIR) models that were reviewed in connection with Chapter 2. This appendix provides a location to explain the categories and subcategories used in the modified evaluation of models in the literature based on Griot (2010). Each model reviewed is provided with a one-page summary of notes in chronological order based on publication date.

This appendix first addresses the inclusion criteria, then the main categories of the interdependent infrastructure model evaluation framework, and then followed by subcategory explanations. Finally, this appendix then presents the notes on the models that met the inclusion criteria.

B.1. Inclusion Criteria, Category Definitions, and Subcategory Definitions

Table B1 explains the inclusion criteria used in the evaluation of the IIR models. The inclusion criteria consist of modeled as network flow, inclusion of assignment or scheduling elements, ability to simultaneously look at multiple infrastructure systems, and incorporation of operational or restorations interdependencies.

Table B1. Definitions of model evaluation inclusion criteria

	Inclusion Criteria	Description
I	Network flow based modeling and simulation	Model or problem formulation must exhibit network flow, or flow of one or more commodities across a network of nodes and arcs (vertices and edges).
II	Assigning/Scheduling repair of damaged assets	Model or problem formulation must include element of scheduling or repair to damaged components of the network(s).
III	Simultaneous modeling and simulation of multiple systems	Model or problem formulation must include multiple infrastructure systems or layers.
IV	Operational or restoration interdependencies	Model or problem formulation must address interdependencies (i.e., operational, restoration, other) between the multiple layers within the overall system of systems.

Table B2 describes all the main categories used in IIR model evaluation which was adopted from Griot's (2010) framework. The categories include everything from modeling focus to characterization of interdependencies to software programs used for the employment of a model and references to publications using this model. There are 13 categories used with two of them distinctly unique to this research.

Table B2. Description of categories used as adapted from Griot (2010)

Category	Description
1 Modeling focus and main objectives	Purpose of model and stated objectives using descriptive language.
2 Domain and scale of application	Infrastructure sectors, cause of disruption, and scale.
3 Methodological design strategy	Bottom-up or top-down approach.
4 Conceptual paradigms	Describes how critical infrastructures, interdependencies, and cascading failures are handled. This includes how these are viewed as well.
5 Mathematical features	Describes the type of program or mathematical approach underlying the model. Also may address specific features such as deterministic/stochastic, dynamic/static, geospatial/non-geospatial, etc.
6 Requirements and resources	Inputs, how model is validated, and how output is verified.
7 Types of outputs	Describes results in words.
8 Advantages and limits	Self-explanatory.
9 Tools	Software, computer, solver, etc.
10 Interoperability	Connection to larger modeling and simulation frameworks or efforts.
11 Recovery Operations*	Key areas of interest in how recovery operations is modeled mainly dealing with explicit or implicit assumptions.
12 References	Self-explanatory.
13 Miscellaneous*	Self-explanatory.

* *Added or modified categories or fields from Griot (2010) for clarity of comparison in present work.*

Tables B3 to B6 describe the subcategories used in the evaluation of IIR models.

Table B3 describes the general model attributes such as model focus, model scenario, and methodology. Table B4 describes the interdependency and coupling characterization and

handling. Table B5 describes the mathematical approach, data requirements, advantages, and limitations. Table B6 describes the recovery operations, prevalent assumptions associated with those operations, and then additional categories.

Table B3. IIR model evaluation subcategories describing general model attributes

Subcategory	Description
1A Model name*	Self-explanatory and only when applicable.
1B Modelling focus	Stated or inferred use or application of the model. May also include generalized category defined by Gonzalez (2017): analytical models, performance evaluation models, design methodologies, mitigation models, and recovery methodologies. May include focus as defined by Eusgeld et al. (2018): interdependency analysis or system analysis. <i>Recovery or restoration methodologies is the implied category for this study.</i>
1C List and description of the objectives of the approach	Includes description of the objective function(s).
2A Sectors being considered	Enumeration of infrastructure systems. Note that this may be dependent on the problem or the associated data used in modeling.
2B Types of threats	Cause of the (simulated) damage or network disruption. May also include Eusgeld et al.'s (2008) categorization of accidents, attacks, or failures.
2C Granularity	Scale of model or infrastructure: Global, Regional/National, Local.
3A Bottom-up or top-down	Bottom-up: Specific information on network/model components leads to general information. Top-down: General information leads to specific results or outputs at network/model components.

* Added or modified categories or fields from Griot (2010) for clarity of comparison in present work.

Table B4. IIR model evaluation subcategories describing interdependencies and coupling

	Subcategory	Description
4A	Critical infrastructure handling	Description of how critical infrastructures are modeled. <i>Network flow is the default for this study.</i>
4B	Critical infrastructure characterization	Description of what critical infrastructure needs and how they are identified (e.g., weighting factor).
4C	Interdependency handling*	Description of how two interdependent infrastructures are related (e.g., binary parameter or constraint based on an interdependent subset).
4D	Operational interdependency type and characterization*	Enumeration of operational interdependency types and how the different types are identified.
4E	Restoration interdependency type and characterization*	Enumeration of restoration interdependency types and how the different types are identified.
4F	Coupling handling and characterization*	Description of coupling between interdependent infrastructure systems (e.g., one-to-one, node-to-node, etc.).
4G	Cascading effect handling	Description of how failure propagates through the network. May include Eusgeld et al.'s (2008) categorization of cascading, escalating, common cause, and confined.

* *Added or modified categories or fields from Griot (2010) for clarity of comparison in present work.*

Table B5. IIR model evaluation subcategories describing mathematical approach, data requirements, advantages, and limitations

	Subcategory	Description
5A	Mathematical techniques	Description of mathematical technique or type of model, e.g., linear program, mixed-integer program, quadratic program, min cost flow, max covering, origin-destination pairs, etc.
5B	Model & simulation approach properties	Model properties such as deterministic/stochastic, dynamic/static, geospatial/non-geospatial, etc. Key assumptions may be listed here as well.
5C	Solution approach*	Description of how solution is found. Identification of heuristics if used.
6A	Data required by the model(s)	Enumeration of data required by the model, i.e., input sets and parameters.
6B	Validation and verification	Description of how the model was validated that it worked as planned/programmed and how the results were verified.
6C	Expertise	Skills or training required to use the model.
7A	Result description	List and description of what results show.
8A	Advantages	Self-explanatory.
8B	Limits	Self-explanatory.
9A	Available tools	Can include software, computer, solver descriptions.
10A	Type of framework	Description of whether or not model is part of larger framework.
10B	Models of interest	Description of other models of interest that the present model relates to or is built from/informed by.

* *Added or modified categories or fields from Griot (2010) for clarity of comparison in present work.*

Table B6. IIR model evaluation subcategories describing recovery operations

Subcategory	Description
11A Teaming structure*	Description of how repair teams are determined, assigned, and utilized if stated.
11B Resource requirements*	Description of assumptions surrounding resources, i.e., material, equipment, vehicles, scarce or long-lead items are handled if stated.
11C Recovery time*	Description of how recovery/repair time is calculated and whether any conditions affect the time of recovery or repair if applicable.
11D Recovery costs*	Description of which costs are used, how they are used, and sources of cost data if applicable.
11E Type of repair*	Description of the type of repair work that is being accomplished if stated.
11F Transit time*	Description of how transit time is accounted for to include between jobs if applicable.
11G Work efficiency*	Description of how work efficiency impacts repair schedule if applicable.
11H Degraded conditions*	Description of circumstances which effect ability to or effectiveness of repair work if applicable.
11I External support*	Description of use of other resources beyond those inherent in the system if applicable.
11J Phases of recovery*	Description of the phases of recovery, e.g., damage assessment, response, recovery, etc. if applicable.
11K Success of recovery*	Description of how repaired assets are determined to be successfully repaired if applicable.
12A Bibliography	Self-explanatory.
12B Expertise resources	Organization producing model if applicable.
12C Websites	Self-explanatory.
12D Maturity	Number of times article or report is cited. For consistency use one site. <i>Google Scholar is used for the present report. Low (<25), Medium (<50), High (<100), Very high (>100).</i>
13A Notes*	Self-explanatory.

* Added or modified categories or fields from Griot (2010) for clarity of comparison in present work.

B.2. Model Evaluations

This section uses the modified IIR evaluation framework described above and displays one-page summaries of notes taken during model evaluation. The following notes are only for those IIR models which were included based on all the above-mentioned inclusion criteria. The models are listed in chronological order by publication date. These notes are not referenced as tables or figures, but are just listed as part of the appendix content, even though they are structured similar to tables. The following shorthand references lay out which models are included to include model name when available.

1. Lee et al. (2007) – Interdependent Layered Network (ILN)
2. Cavdaroglu et al. (2013)
3. Sharkey et al. (2015) – Interdependent Integrated Network Design and Scheduling (IINDS) Problem
4. González et al. (2016) – Iterative Interdependent Network Design Problem (iINDP)
5. González (2017) – Time-dependent Interdependent Network Design Problem (td-INDP)
6. González (2017) – Stochastic Interdependent Network Design Problem (sINDP)
7. Almoghathawi et al. (2019)

1 Modeling focus and main objectives	Model name* Modelling focus List and description of the objectives of the approach	Interdependent Layer Network (ILN) Least cost recovery strategies Minimize cost of flow; Minimize unmet weighted demand at nodes and in origin-destination pairs; Minimize disruptions to flow costs associated with interdependent service disruption
2 Domain and scale of application	Sectors being considered Types of threats Granularity	Services: power, telecommunications, subway/transit Undetermined event caused tunnel collapse (magnitude similar to World Trade Center disaster of September 11, 2001) Local (community)
3 Methodological design strategy	Bottom-up or top-down	Bottom-up
4 Conceptual paradigms	Critical infrastructure handling Critical infrastructure characterization Interdependency handling* Operational interdependency type and characterization* Restoration interdependency type and characterization* Coupling handling and characterization* Cascading effect handling	Network flow Demand met Connector variable y between two infrastructure networks; variable r used for EXCLUSIVE OR interdependencies Uses five types of interrelationships between infrastructure networks: 1) input dependence, 2) mutual dependence, 3) shared dependence, 4) EXCLUSIVE OR dependence, and 5) colocated dependence Connector variable y represents either node-to-node or node-to-arc coupling on a one-to-one basis Unclear, seems to be input manually when setting up the problem based on knowledge of planned event; Some propagation will occur due to interdependencies inserted in the data set
5 Mathematical features	Mathematical techniques Model & simulation approach properties Solution approach*	Network based model; Mixed integer program (MIP) Deterministic Optimality found using MIP; Allusions to using LP relaxation and possible linear algorithms
6 Requirements and resources	Data required by the model(s) Validation and verification Expertise	Built data set and database; Physical layout of system including supply, demand, and capacities; Due to telecommunications and subway requirements, origin-destination pairs were needed (O-D matrix) Set of solution options delivered to decision makers and used to inform decisions This is a event specific model, built from the building blocks and may require additional constraints to be programmed (AMPL coding experience)
7 Types of outputs	Result description	Restoration plans; Showed several different cases with varying constraints that was then used to develop decision space for infrastructure managers; Lists of unmet demands for service
8 Advantages and limits	Advantages Limits	Builds in interdependencies between networks; Able to generate optimal recovery strategy where all damage and resources are known Requires 'acceptable timeframe' for recovery operations without defining term; Can not support where resources change over time; Damage can not occur at multiple points in time
9 Tools	Available tools	Laptop with Pentium M processor operating at 1.6 GHz and 1 GB RAM; Programmed in AMPL using CPLEX; Integrated with GIS as a user interface
10 Interoperability	Type of framework Models of interest	
11 Recovery Operations*	Teaming structure* Resource requirements* Recovery time* Recovery costs* Type of repair* Transit time* Work efficiency* Degraded conditions* External support* Phases of recovery* Success of recovery*	Fixed costs or charges associated with temporary arcs or temporary nodes listed in notation, q and qq , but not in formulation Temporary fixes or shunts for power distribution, where a delineation existed when a full repair was needed; variable z is mentioned as an indicator if temp arc or node is to be in an infrastructure and shown in constraints (39-40)
12 References	Bibliography Expertise resources Websites Maturity	Lee II, E. E., Mitchell, J. E., & Wallace, W. A. (2007). Restoration of services in interdependent infrastructure systems: A network flows approach. IEEE Transactions on Systems, Man, and Cybernetics, Part C (Applications and Reviews), 37(6), 1303-1317. https://ieeexplore.ieee.org/abstract/document/4343992 Very high; cited 360 times as of 20 April 2021
13 Miscellaneous*	Notes*	Good general definitions including service, material, disruption, service degradation, interdependence, etc. Introduces computational power of a laptop being required in order to be of use to emergency managers.

1 Modeling focus and main objectives	Model name* Modelling focus List and description of the objectives of the approach	No name given in the article; however, I have referred to this as the Interdependent Layer Network Plus (ILN+) based on similarity to Lee II et al. (2007) Least cost recovery strategy Minimize the cost of flow; Minimize the cost of unmet demand; Minimize the cost of unmet demand based on interdependencies; Minimize the cost of installation or recovery of an arc; Minimize the assignment cost
2 Domain and scale of application	Sectors being considered Types of threats Granularity	Services: power, telecommunications Unspecified damage to power system Local (community)
3 Methodological design strategy	Bottom-up or top-down	Bottom-up
4 Conceptual paradigms	Critical infrastructure handling Critical infrastructure characterization Interdependency handling* Operational interdependency type and characterization* Restoration interdependency type and characterization* Coupling handling and characterization* Cascading effect handling	Network flow Demand met Connector variable y between two infrastructure networks; Special set $F(m,n)$ where the interdependency is (i,j) in $F(m,n)$ where i in B^m and j in A^n Physical or input dependency similar to Lee II et al. (2007) Node-to-node as defined by interdependency set $F(m,n)$, which represents a one-to-one coupling Unclear; Some propagation will occur due to interdependencies inserted in the data set
5 Mathematical features	Mathematical techniques Model & simulation approach properties Solution approach*	Network based model; Mixed integer program (MIP); Damage considered only as arcs by using network extension technique Deterministic Data pre-processing, which significantly reduced instance size (e.g., 547 nodes in V_telecom. Went to 17), which still caused problem and no instance was solved to optimality with model due to CPLEX memory management; Specialized heuristic solution method
6 Requirements and resources	Data required by the model(s) Validation and verification Expertise	
7 Types of outputs	Result description	
8 Advantages and limits	Advantages Limits	Use of two cost penalty structures on unmet demand can be used to get large portions of the network back up and operational within a specific timeframe; Model fully integrates restoration planning and scheduling efforts; Objective function provides a measure of how well the services are being restored throughout the recovery effort, rather than at the end Assumed all workers had sufficient skills to accomplish any task in the set; Assumed each task only required one work crew; Assumed all crews were under jurisdiction of manager and so no assignment costs were given; Managers may have limited access to commercial software for MIP;
9 Tools	Available tools	Laptop with the Intel Core 2 Duo processor at 2.26 GHz and 4 GB RAM; OPL Development Studio 6.3 using CPLEX 12.1
10 Interoperability	Type of framework Models of interest	
11 Recovery Operations*	Teaming structure* Resource requirements* Recovery time* Recovery costs* Type of repair* Transit time* Work efficiency* Degraded conditions* External support* Phases of recovery* Success of recovery*	Three work parallel work groups There is time required by work group to complete a task There is an assignment cost in the formulation but it is not used; There is a fixed cost of installing a temporary arc Temporary fixes with no specific mention of anything else
12 References	Bibliography Expertise resources Websites Maturity	Cavdaroglu et al., 2013 https://link.springer.com/article/10.1007/s10479-011-0959-3
13 Miscellaneous*	Notes*	No model name given in article, introduces integrated network design and scheduling problems, but the formulation is closer to the ILN (Lee et al. 2007) than the INDS (Nurre et al. 2012) and adds a scheduling/assignment problem component

1 Modeling focus and main objectives	Model name* Modelling focus	Interdependent Integrated Network Design and Scheduling (IINDS) Problem Timing of recovery activities; Selection of nodes and arcs to restore; Scheduling repairs on parallel identical work groups; Interdependent network flow; Value of information sharing across networks
	List and description of the objectives of the approach	Maximizing the cumulative performance of the network over a finite period of time
2 Domain and scale of application	Sectors being considered	Services for Hannover data: power, telecommunications, water, wastewater Services for CLARC data: power, telecommunications, transportation, wastewater
	Types of threats	Natural disaster: Hannover - Category 3 hurricane; CLARC - unspecified medium- and large-scale
	Granularity	Hannover: Local; CLARC: Regional
3 Methodological design strategy	Bottom-up or top-down	Bottom-up
4 Conceptual paradigms	Critical in infrastructure handling	Network flow Cumulative weighted flow
	Critical in infrastructure characterization	
	Interdependency handling*	Binary variables for physical connection (y), traditional and effectiveness precedence (x), time sensitive options (o and rho)
	Operational interdependency type and characterization*	Operational interdependencies in Hannover data are power lead, meaning it is dependencies on power from the other networks; Operational interdependencies in CLARC data are multi-directional (e.g., power-to-trans & trans-to-power), see Table 14
	Restoration interdependency type and characterization*	Restoration interdependencies in CLARC data were developed by visual examination of the GIS data to determine proximity between power lines and roadways for traditional precedence & flood zones and wastewater pumps for time-sensitive cleanup tasks; time-sensitive refueling tasks were constant through various scenarios based on refueling requirements for generators at cell towers
	Coupling handling and characterization*	One-to-one and node-to-node by using set $F(m,n)$ for operational (physical) interdependencies; Restoration interdependencies largely were arc-to-arc based on the presentation using the Network Extension technique which allowed all nodes to be represented by arcs
	Cascading effect handling	Physical interdependencies cause failure propagation in the system, but disaster scenarios were created using HAZUS on their datasets.
5 Mathematical features	Mathematical techniques	Network based model; Mixed integer program (MIP);
	Model & simulation approach properties	Discrete events; Deterministic
	Solution approach*	Optimality using MIP; Network extension technique for model presentation brevity; Various heuristics for decision-making environments
6 Requirements and resources	Data required by the model(s)	Nodes, arcs, interdependencies, restoration interdependencies (precedence requirements), damage scenario
	Validation and verification	For different decision-making environments it uses the centralized optimal solution to base the effectiveness of the others on; No general validation of the model was discussed;
	Expertise	
7 Types of outputs	Result description	i) set of components to be installed (design decisions) ii) assignment of selected components to work crews (scheduling decisions) iii) flow of services based on current operational components (interdependent decisions)
8 Advantages and limits	Advantages	Ability to quantify value of information-sharing; Integration of multiple restoration interdependencies;
	Limits	Perfect information-sharing vs. real life estimations (no uncertainty); Not all operational interdependencies or restoration interdependencies are examined
9 Tools	Available tools	Laptop computer using IBM ILOG CPLEX Optimization Studio 12.2
10 Interoperability	Type of framework	
	Models of interest	
11 Recovery Operations*	Teaming structure*	Teams associated with a given infrastructure m, meaning they have the skills and ability to address any issues on that infrastructure
	Resource requirements* Recovery time*	Processing time used as the only resource requirement including normal and extended processing time
	Recovery costs* Type of repair*	Repaired only arcs, with the idea that a node could be viewed as an arc by splitting the node and adding an arc
	Transit time* Work efficiency*	Called effectiveness precedence and it means that if certain tasks are not done in order they will continue at a slower rate
	Degraded conditions* External support*	Only example of this is in the measure of work efficiency
	Phases of recovery* Success of recovery*	Certain tasks need to be accomplished first and then others Alluded to as future work
12 References	Bibliography	Sharkey, T. C., Cavdaroglu, B., Nguyen, H., Holman, J., Mitchell, J. E., & Wallace, W. A. (2015). Interdependent network restoration: On the value of information-sharing. <i>European Journal of Operational Research</i> , 244(1), 309-321.
	Expertise resources Websites Maturity	https://www.sciencedirect.com/science/article/abs/pii/S0377221714010698 High: cited 71 times as of 23 April 2021
13 Miscellaneous*	Notes*	Very thorough and one of the better models capturing all the salient model characteristics of importance in the present research

1 Modeling focus and main objectives	Model name* Modelling focus List and description of the objectives of the approach	Iterative Interdependent Network Design Problem (iINDP) Least-cost recovery strategies Maximize commodity flow (using surplus and deficit costs); Minimize costs associated with reconstruction/restoration of damaged arcs/nodes; Minimize cost of flow; Realize savings in preparation for reconstruction based on geospatial relationships;
2 Domain and scale of application	Sectors being considered Types of threats Granularity	Services: Gas, water, power Natural disaster (earthquake) Regional (county)
3 Methodological design strategy	Bottom-up or top-down	Bottom-up
4 Conceptual paradigms	Critical infrastructure handling Critical infrastructure characterization Interdependency handling* Operational interdependency type and characterization* Restoration interdependency type and characterization* Coupling handling and characterization* Cascading effect handling	Network flow Percentage of demand supplied Interdependency parameter based on four different coupling strategies (used any-to-one coupling strategy) Physical Stated that model can additionally support cyber, logical, and geographical from Rinaldi et al.'s (2001) four interdependency types Geographical repair, though this is just cited as one of the operational interdependencies since the distinction between operational and restoration interdependencies is not used by the authors and not part of the lexicon of the original interdependency type definition (see Rinaldi et al., 2001) Mentions four different coupling strategies which can be classified as one-to-one, one-to-any, one-to-all, and one-to-many; Text definitions are given for all of them, with one-to-any being chosen as the one used in the model; Authors suggested additional variables and parallel constraints would be necessary to incorporate all of the different coupling strategies and interdependency types Failure models based on regional model developed by Adachi and Ellingwood (2009)
5 Mathematical features	Mathematical techniques Model & simulation approach properties Solution approach*	Network based model; Multiplex construct; Mixed integer programming (MIP); Deterministic; Discrete events; Small instances solved to optimality; Iterative heuristic for larger instances leveraging td-INDP
6 Requirements and resources	Data required by the model(s) Validation and verification Expertise	Information associated with partially destroyed network (costs, capacities, damaged components, etc.) td-INDP results (optimal solution)
7 Types of outputs	Result description	Recovery process that maximizes the resilience of the system
8 Advantages and limits	Advantages Limits	Significant reduction of computational time (able to use in real-time applications) (exponential increase changes to linear increase with increases to time periods analyzed); Allows periodic updates to parameters, which may reflect reality better during recovery Splitting the time horizon and iteratively solving shorter periods might not accurately depict optimal recovery; Depends on level of interdependency, resource limitations, and level of initial destruction
9 Tools	Available tools	GIS interface used for data visualization;
10 Interoperability	Type of framework Models of interest	
11 Recovery Operations*	Teaming structure* Resource requirements* Recovery time* Recovery costs* Type of repair* Transit time* Work efficiency* Degraded conditions* External support* Phases of recovery* Success of recovery*	Model capable of handling multiple types of resources for a given node or arc Assumed to be able to be completed within time period; No specific time requirements were given for any nodes or arcs, though the model seems to be able to support this level of information Cost was modeled as recovery costing one resource unit (not specified) and interpreted as able to recover specified amount of nodes and arcs each time period; No realistic costs were associated with the recovery time No partial repair and no dilineation between expedient, temporary, or full repair
12 References	Bibliography Expertise resources Websites Maturity	González, A. D., Dueñas-Osorio, L., Sánchez-Silva, M., & Medaglia, A. L. (2016). The interdependent network design problem for optimal infrastructure system restoration. <i>Computer-Aided Civil and Infrastructure Engineering</i> , 31(5), 334-350. https://onlinelibrary.wiley.com/doi/ful/10.1111/micc.12171?casa_token=Qb0jYXD2hEcAAAAA%3AsA0barqED4GCs0xa_25pu6OG3o-epYrICxGR3B5cqsMn4ioeT0BCCAKbxJQdKXPRKMAzWZ1hoEE6CsAfg Very high; cited 158 times as of 23 April 2021
13 Miscellaneous*	Notes*	This model provides a way to insert partial knowledge or developing knowledge after a disruption as well as a way to capture the shifting priorities; very good basis for considering multiple interdependencies and couplings between infrastructures

1 Modeling focus and main objectives	Model name* Modelling focus List and description of the objectives of the approach	Time-Dependent Interdependent Network Design Problem (td-INDP) Least-cost recovery strategies Maximize commodity flow (using surplus and deficit costs); Minimize costs associated with reconstruction/restoration of damaged arcs/nodes; Minimize cost of flow; Realize savings in preparation for reconstruction based on geospatial relationships;
2 Domain and scale of application	Sectors being considered Types of threats Granularity	Services: Gas, water, power Natural disaster (earthquake) Regional (county)
3 Methodological design strategy	Bottom-up or top-down	Bottom-up
4 Conceptual paradigms	Critical infrastructure handling Critical infrastructure characterization Interdependency handling* Operational interdependency type and characterization* Restoration interdependency type and characterization* Coupling handling and characterization* Cascading effect handling	Network flow Percentage of demand supplied Interdependency parameter based on four different coupling strategies (used any-to-one coupling strategy) Physical Stated that model can additionally support cyber, logical, and geographical from Rinaldi et al.'s (2001) four interdependency types Geographical repair, though this is just cited as one of the operational interdependencies since the distinction between operational and restoration interdependencies is not defined by the original developer of the interdependency type. Uses a one-to-any coupling with a node-to-node construct Failure models based on regional model developed by Adachi and Ellingwood (2009)
5 Mathematical features	Mathematical techniques Model & simulation approach properties Solution approach*	Network based model; Multiplex construct; Mixed integer programming (MIP); Deterministic; Discrete events Solved to optimality; Decomposition (Bender's Cut)
6 Requirements and resources	Data required by the model(s) Validation and verification Expertise	Information associated with partially destroyed network (costs, capacities, damaged components, etc.)
7 Types of outputs	Result description	
8 Advantages and limits	Advantages Limits	 Doesn't model communication/authority through crisis command structure (e.g., inclusion of ICT infrastructure network and some logical interdependencies); Although capable of different configurations or coupling all nodes were coupled in the same manner; Assumes complete and perfect knowledge at time of disruption;
9 Tools	Available tools	
10 Interoperability	Type of framework Models of interest	
11 Recovery Operations*	Teaming structure* Resource requirements* Recovery time* Recovery costs* Type of repair* Transit time* Work efficiency* Degraded conditions* External support* Phases of recovery* Success of recovery*	Model capable of handling multiple types of resources for a given node or arc Assumed to be able to be completed within time period; No specific time requirements were given for any nodes or arcs, though the model seems to be able to support this level of information Cost was modeled as recovery costing one resource unit (not specified) and interpreted as able to recover specified amount of nodes and arcs each time period; No realistic costs were associated with the recovery time No partial repair and no delineation between expedient, temporary, or full repair
12 References	Bibliography Expertise resources Websites Maturity	Gonzalez Huertas, A. D. (2017). Resilience optimization of systems of interdependent networks (Doctoral dissertation). González, A. D., Dueñas-Osorio, L., Medaglia, A. L., & Sánchez-Silva, M. (2016, May). The time-dependent interdependent network design problem (td-INDP) and the evaluation of multi-system recovery strategies in polynomial time. In The 6th Asian-Pacific Symp. on Struct. Reliab. its Appl (pp. 544-550). https://scholarship.rice.edu/handle/1911/105511 Low: cited 15 times as of 23 April 2021 (Conf. Article); dissertation not cited
13 Miscellaneous*	Notes*	td-INDP serves as a basis for iINDP, sINDP, and INRG; all model spin offs are included because they generally address the same things, but have nuances that make them better in certain regards

1 Modeling focus and main objectives	Model name* Modelling focus List and description of the objectives of the approach	Stochastic Interdependent Network Design Problem (siNDP) Least-cost recovery strategies Maximize commodity flow (using surplus and deficit costs); Minimize costs associated with reconstruction/restoration of damaged arcs/nodes; Minimize cost of flow; Realize savings in preparation for reconstruction based on geospatial relationships; Account for uncertainty about the physical and logical properties of the system
2 Domain and scale of application	Sectors being considered Types of threats Granularity	Services: Gas, water, power Natural disaster (earthquake) Regional (county)
3 Methodological design strategy	Bottom-up or top-down	Bottom-up
4 Conceptual paradigms	Critical infrastructure handling Critical infrastructure characterization Interdependency handling* Operational interdependency type and characterization* Restoration interdependency type and characterization* Coupling handling and characterization* Cascading effect handling	Network flow Percentage of demand supplied Interdependency parameter based on four different coupling strategies (used any-to-one coupling strategy) Physical Stated that model can additionally support cyber, logical, and geographical from Rinaldi et al.'s (2001) four interdependency types Geographical repair, though this is just cited as one of the operational interdependencies since the distinction between operational and restoration interdependencies is not defined by the original developer of the interdependency type. Used one-to-any in a node-to-node construct Failure models based on regional model developed by Adachi and Ellingwood (2009)
5 Mathematical features	Mathematical techniques Model & simulation approach properties Solution approach*	Network based model; Multiplex construct; Mixed integer programming (MIP); Stochastic embedded optimization Stochastic optimization; Monte Carlo simulation; Solved to optimality with MIP
6 Requirements and resources	Data required by the model(s) Validation and verification Expertise	Information associated with partially destroyed network (costs, capacities, damaged components, etc.)
7 Types of outputs	Result description	
8 Advantages and limits	Advantages Limits	Introduces set of scenarios which add uncertainty to certain parameters (supply & demand of commodities, availability of resources, use of resources in recovery); Ability to adjust levels of uncertainty and level of knowledge Doesn't model communication/authority through crisis command structure (e.g., inclusion of ICT infrastructure network and some logical interdependencies); Although capable of different configurations or coupling all nodes were coupled in the same manner; Assumes complete and perfect knowledge at time of disruption;
9 Tools	Available tools	Julia modeling language for Mathematical Optimization (JuMP); Solvers: Gurobi v7.0.1, Xpress-MP v7.9, CPLEX v12.7, and L-shaped decomposition of CPLEX v12.7
10 Interoperability	Type of framework Models of interest	
11 Recovery Operations*	Teaming structure* Resource requirements* Recovery time* Recovery costs* Type of repair* Transit time* Work efficiency* Degraded conditions* External support* Phases of recovery* Success of recovery*	Added uncertainty and variability to the availability of resources at any given time t and the amount of resources required for repair; Assumed to be able to be completed within time period; No specific time requirements were given for any nodes or arcs, though the model seems to be able to support this level of information Cost was modeled as recovery costing one resource unit (not specified) and interpreted as able to recover specified amount of nodes and arcs each time period; No realistic costs were associated with the recovery time No partial repair and no delineation between expedient, temporary, or full repair Uncertainty added to parameters such as flow cost (c), availability of resources (v), resources required to repair (p and h), penalty costs ($M+$ and $M-$) Uncertainty was added to the following variables dealing with functionality and operations of the networks: flow (x), operability (w and y), slack (δ_{l+} and δ_{l-})
12 References	Bibliography Expertise resources Websites Maturity	Gonzalez Huertas, A. D. (2017). Resilience optimization of systems of interdependent networks (Doctoral dissertation). https://scholarship.rice.edu/handle/1911/105511 Low, cited 0 times as of 23 April 2021 (dissertation)
13 Miscellaneous*	Notes*	Addresses uncertainty of 1) failure modes and 2) physical and logical properties of the system and possible errors quantifying them

1 Modeling focus and main objectives	Model name* Modelling focus List and description of the objectives of the approach	No name given in reference article; I have referred to it as Multi-objective Restoration Model (MORM) Maximum resilience for least-cost recovery strategies Maximizing the resilience of the system of interdependent infrastructure networks; Minimizing the costs associated with the restoration process, including flow, disruption, and restoration costs
2 Domain and scale of application	Sectors being considered Types of threats Granularity	Simulated services: power and water Disruptions random, malevolent (capacity and degree), and spatial
3 Methodological design strategy	Bottom-up or top-down	Bottom-up
4 Conceptual paradigms	Critical infrastructure handling Critical infrastructure characterization Interdependency handling* Operational interdependency type and characterization* Restoration interdependency type and characterization* Coupling handling and characterization* Cascading effect handling	Network flow Contribution to resilience Interdependency set; Separate set of node couples that have interdependence; Formulation allows for i_{bar} in k_{bar} can't be operational unless i in k is operational. i in k can be operational and i_{bar} in k_{bar} may or may not be operational to satisfy the inequality constraints (22) Physical None Cascading failures are not considered in this work; Failure propagation may happen due to interdependencies following disruptions (i.e., manmade accidents, malevolent attacks, or natural disasters);
5 Mathematical features	Mathematical techniques Model & simulation approach properties Solution approach*	Network based model; Multiplex construct; Mixed integer programming (MIP); Multi-objective handled by epsilon-constraint method; Deterministic; Discrete events over certain ranges Solved to optimality using MIP;
6 Requirements and resources	Data required by the model(s) Validation and verification Expertise	Used fictional dataset, generated from extended algorithm for proximal topology generator, Generated individual networks and then built interdependencies among them;
7 Types of outputs	Result description	
8 Advantages and limits	Advantages Limits	Including a resilience measure in the objective function enables future exploration of the balance between "withstanding a disruption" and "recovering from a disruption" which represent the two primary dimensions of resilience; One crew to task and no allowance for multiple crews to task; No partial disruption, either disrupted or operational; Only physical interdependency; Fictitious data set
9 Tools	Available tools	LINGO 17.0
10 Interoperability	Type of framework Models of interest	
11 Recovery Operations*	Teaming structure* Resource requirements* Recovery time* Recovery costs* Type of repair* Transit time* Work efficiency* Degraded conditions* External support* Phases of recovery* Success of recovery*	Set of work crews assigned to each network and assumed to have the necessary resources to accomplish that task; Work crews may be different from one infrastructure network to another (non-parallel or non-identical work groups); Other resources are assumed to be inherent to recovery crews and are not considered separately Restoration time associated with recovery; Recovery durations are not fixed or the same for all disrupted components; Cost associated with node or link recovery/restoration; Different for each link and node, but constant over time; No partial repair
12 References	Bibliography Expertise resources Websites Maturity	Almoghathawi et al., 2019 https://www.sciencedirect.com/science/article/abs/pii/S0951832017314175
13 Miscellaneous*	Notes*	

Appendix C. The Lite Base Interdependent Infrastructure Recovery Model (LiteBIIRM)

This appendix details the goals, assumptions, notation, and formulation for the complete LiteBIIRM model as seen in Chapter 4.

C.1. LiteBIIRM Goals

The goal of this model is comprised of two parts to allow for all four coupling strategies and partial operability.

C.2. LiteBIIRM Assumptions

The assumptions for the LiteBIIRM are nearly identical to the assumptions of the BIIRM except for the following assumptions:

- A node or arc that is directly damaged is not operational until it is restored. A node that has some operational interdependency with a damaged node may be inoperable or partially operable based on the coupling strategy. Direct damage is assumed to create total inoperability, which can be repaired.
- Operational interdependencies subtypes (i.e., physical, cyber, logical, or geospatial) are assumed to exist between node pairs and can be described based on the interdependency subtype and a coupling strategy. Operational interdependency coupling of node pairs can be achieved at least four ways, including one-to-one, one-to-any, one-to-all, and one-to-many (González et al. 2016).

- Operational interdependencies may affect a node’s level of operability and the use of a pseudo node within an infrastructure layer can be used to ensure some level of operability remains in a one-to-many relationship.
- No restoration interdependencies are included, due to the focused concentration on the coupling of interdependent systems.

C.3. LiteBIIRM Notation

This section lists the sets, parameters, and variables used in the LiteBIIRM. The listing is alphabetical with symbols from the Latin alphabet first followed by the Greek alphabet. Unless otherwise explicitly stated the index t denotes “during time period $t \in \mathcal{T}$ ” where \mathcal{T} is the set of all time periods.

\mathcal{A} = overall set of arcs, indexed as (i, j) ;

\mathcal{A}^k = subset of arcs within a given infrastructure layer $k \in \mathcal{K}$;

\mathcal{A}' = overall set of damaged arcs;

\mathcal{A}'^k = subset of damaged arcs within a given layer $k \in \mathcal{K}$;

a_{wt}^k = cost of assigning work crew $w \in \mathcal{W}^k$;

b_{ilt}^k = supply or demand of commodity $l \in \mathcal{L}^k$ at node $i \in \mathcal{N}^k$;

c_{ijlt}^k = cost of flowing commodity $l \in \mathcal{L}^k$ through arc $(i, j) \in \mathcal{A}^k$;

\mathcal{L} = overall set of commodities;

\mathcal{L}^k = subset of commodities able to flow within a given layer $k \in \mathcal{K}$;

\mathcal{N} = overall set of nodes, indexed as i ;

\mathcal{N}^k = subset of nodes within a given infrastructure layer $k \in \mathcal{K}$;

\mathcal{N}' = set of all damaged nodes;

\mathcal{N}'^k = subset of damaged nodes within a given layer $k \in \mathcal{K}$;
 p_i^k or p_{ij}^k = normal processing time for repair of node $i \in \mathcal{N}'^k$ or arc $(i, j) \in \mathcal{A}'^k$;
 q_{ijt}^k or q_{it}^k = cost of repair for recovery task at arc $(i, j) \in \mathcal{A}'^k$ or node $i \in \mathcal{N}'^k$;
 u_{ijt}^k = capacity of arc $(i, j) \in \mathcal{A}^k$ shared by all commodities flowing along that arc;
 \mathcal{W} = set of all work crews;
 \mathcal{W}^k = subset of work crews able to perform tasks in infrastructure layer $k \in \mathcal{K}$;
 x_{ijlt}^k = variable representing flow of commodity $l \in \mathcal{L}^k$ along arc $(i, j) \in \mathcal{A}^k$;
 $x_{ilt}^{-,k}$ = slack variable representing unmet demand of commodity $l \in \mathcal{L}^k$ at node $i \in \mathcal{N}^k$;
 $x_{ilt}^{+,k}$ = slack variable representing surplus of commodity $l \in \mathcal{L}^k$ at node $i \in \mathcal{N}^k$;
 y_{ijt}^k or y_{it}^k = variable taking a value between 0 and 1, indicating if arc $(i, j) \in \mathcal{A}^k$ or node $i \in \mathcal{N}^k$ is operable;
 α_{ijwt}^k or α_{iwt}^k = binary variable indicating if work crew $w \in \mathcal{W}^k$ is assigned to a recovery task during time period $t \in \mathcal{T}$;
 β_{ijwt}^k or β_{iwt}^k = binary variable indicating if work crew $w \in \mathcal{W}^k$ has completed the recovery task by the beginning of time period $t \in \mathcal{T}$;
 $\gamma_{i\bar{i}\psi\xi t}^{k\bar{k}}$ = operational interdependency parameter based on parent-child node pairs $i \in \mathcal{N}_{i\bar{i}\psi\xi}^{k\bar{k}}$ with some operational interdependency type $\psi \in \Psi$;
 μ_A and μ_B = weighting parameter for cost objective and disruptive effect objective;
 μ_{ijt}^k or μ_{it}^k = weighting parameter for arc $(i, j) \in \mathcal{A}'^k$ or node $i \in \mathcal{N}'^k$ at time period $t \in \mathcal{T}$;
 Ξ = set of coupling strategies, indexed as ξ ;

Ψ = set of operational interdependency subtypes, indexed as ψ ;

C.4. LiteBIIRM Formulation

The following is the full formulation of the LiteBIIRM. Equations may have a suffix ascribed denoting a variation based on being arc-based instead of node-based (no suffix). The formulation of the LiteBIIRM was builds upon the work of González et al. (2016) and Cavdaroglu et al. (2013).

C.4.1. Objective functions

$$\text{Cost Objective: } A = \sum_{t \in \mathcal{T}} \sum_{k \in \mathcal{K}} \left(\sum_{w \in \mathcal{W}^k} \left[\sum_{(i,j) \in \mathcal{A}'^k} (q_{ijt}^k \alpha_{ijwt}^k + a_{wt}^k p_{ij}^k \alpha_{ijwt}^k) + \sum_{i \in \mathcal{N}'^k} (q_{it}^k \alpha_{iwt}^k + a_{wt}^k p_i^k \alpha_{iwt}^k) \right] + \sum_{l \in \mathcal{L}^k} \sum_{(i,j) \in \mathcal{A}^k} c_{ijlt}^k x_{ijlt}^k \right). \quad (\text{C.1})$$

$$\text{Disruption Objective: } B = \sum_{t \in \mathcal{T}} \sum_{k \in \mathcal{K}} \left(\sum_{i \in \mathcal{N}^k} \mu_{it}^k y_{it}^k + \sum_{(i,j) \in \mathcal{A}^k} \mu_{ijt}^k y_{ijt}^k \right). \quad (\text{C.2})$$

These two explicit objective functions also include a time index, thus incorporating repair time into the combined objective functions implicitly as follows.

$$\text{Minimize } \mu_A A - \mu_B B. \quad (\text{C.3})$$

Subject to the following constraints

C.4.2. Network flow and scheduling constraints

$$\sum_{j:(i,j) \in \mathcal{A}^k} x_{ijlt}^k - \sum_{j:(j,i) \in \mathcal{A}^k} x_{jilt}^k = b_{ilt}^k + x_{ilt}^{-,k} - x_{ilt}^{+,k}, \quad \forall i \in \mathcal{N}^k, l \in \mathcal{L}^k, k \in \mathcal{K}, t \in \mathcal{T}. \quad (\text{C.4})$$

$$\sum_{l \in \mathcal{L}^k} x_{ijlt}^k \leq u_{ijt}^k y_{it}^k, \quad \forall (i,j) \in \mathcal{A}^k, i \in \mathcal{N}^k, k \in \mathcal{K}, t \in \mathcal{T}. \quad (\text{C.5})$$

$$\sum_{l \in \mathcal{L}^k} x_{ijlt}^k \leq u_{ijt}^k y_{jt}^k, \quad \forall (i,j) \in \mathcal{A}^k, j \in \mathcal{N}^k, k \in \mathcal{K}, t \in \mathcal{T}. \quad (\text{C.6})$$

$$\sum_{l \in \mathcal{L}^k} x_{ijlt}^k \leq u_{ijt}^k y_{ijt}^k, \quad \forall (i,j) \in \mathcal{A}^k, k \in \mathcal{K}, t \in \mathcal{T}. \quad (\text{C.7})$$

$$y_{it}^k \leq \sum_{w \in \mathcal{W}^k} \sum_{\tau=1}^t \beta_{iwt}^k, \quad \forall i \in \mathcal{N}'^k, k \in \mathcal{K}, t \in \mathcal{T}. \quad (\text{C.8})$$

$$y_{ijt}^k \leq \sum_{w \in \mathcal{W}^k} \sum_{\tau=1}^t \beta_{ijw\tau}^k, \quad \forall (i,j) \in \mathcal{A}'^k, k \in \mathcal{K}, t \in \mathcal{T}. \quad (\text{C.8.arc})$$

$$\sum_{t \in \mathcal{T}} \sum_{w \in \mathcal{W}^k} \beta_{iwt}^k \leq 1, \quad \forall i \in \mathcal{N}'^k, k \in \mathcal{K}. \quad (\text{C.9})$$

$$\sum_{t \in \mathcal{T}} \sum_{w \in \mathcal{W}^k} \beta_{ijwt}^k \leq 1, \quad \forall (i, j) \in \mathcal{A}'^k, k \in \mathcal{K}. \quad (\text{C.9.arc})$$

$$\sum_{t \in \mathcal{T}} \sum_{w \in \mathcal{W}^k} \alpha_{iwt}^k \leq 1, \quad \forall i \in \mathcal{N}'^k, k \in \mathcal{K}. \quad (\text{C.10})$$

$$\sum_{t \in \mathcal{T}} \sum_{w \in \mathcal{W}^k} \alpha_{ijwt}^k \leq 1, \quad \forall (i, j) \in \mathcal{A}'^k, k \in \mathcal{K}. \quad (\text{C.10.arc})$$

$$\beta_{iwt}^k \leq \sum_{\tau=1}^{\min[T, t-p_i^k]} \alpha_{iwt}^k, \quad \forall i \in \mathcal{N}'^k, w \in \mathcal{W}^k, k \in \mathcal{K}, t \in \mathcal{T}. \quad (\text{C.11})$$

$$\beta_{ijwt}^k \leq \sum_{\tau=1}^{\min[T, t-p_{ij}^k]} \alpha_{ijw\tau}^k, \quad \forall (i, j) \in \mathcal{A}'^k, w \in \mathcal{W}^k, k \in \mathcal{K}, t \in \mathcal{T}. \quad (\text{C.11.arc})$$

$$\sum_{\tau=1}^{\min[T, t+p_i^k-1]} \sum_{i \in \mathcal{N}'^k} \alpha_{iwt}^k + \sum_{\tau=1}^{\min[T, t+p_{ij}^k-1]} \sum_{(i, j) \in \mathcal{A}'^k} \alpha_{ijw\tau}^k \leq 1 + \sum_{\tau=p_{ij}^k+1}^t \sum_{i \in \mathcal{N}'^k} \beta_{iwt}^k + \sum_{\tau=p_{ij}^k+1}^t \sum_{(i, j) \in \mathcal{A}'^k} \beta_{ijw\tau}^k, \quad \forall w \in \mathcal{W}^k, k \in \mathcal{K}, t \in \mathcal{T}. \quad (\text{C.12})$$

C.4.3. Operational interdependencies

$$\sum_{i \in \mathcal{N}_{i\psi\xi}^{k\tilde{k}}} \gamma_{i\psi\xi t}^{k\tilde{k}} y_{it}^k \geq y_{it}^{\tilde{k}}, \quad \xi = \text{one2one}, \text{one2any}, \text{one2many}, \forall i \in \mathcal{N}^{\tilde{k}}, \tilde{k} \in \mathcal{K}, \psi \in \Psi, t \in \mathcal{T}. \quad (\text{C.13})$$

$$\gamma_{i\psi\xi t}^{k\tilde{k}} y_{it}^k \geq y_{it}^{\tilde{k}}, \quad \xi = \text{one2all}, \forall i \in \mathcal{N}_{i\psi\xi}^{k\tilde{k}}, \tilde{i} \in \mathcal{N}^{\tilde{k}}, \tilde{k} \in \mathcal{K}, \psi \in \Psi, t \in \mathcal{T}. \quad (\text{C.14})$$

$$y_{it}^k b_{ilt}^k \geq b_{ilt}^k + x_{ilt}^{-,k}, \quad \forall i \in \mathcal{N}_D^k, l \in \mathcal{L}^k, k \in \mathcal{K}, t \in \mathcal{T}. \quad (\text{C.15})$$

C.4.4. Side constraints

$$x_{ijlt}^k \geq 0, \quad \forall (i, j) \in \mathcal{A}^k, l \in \mathcal{L}^k, k \in \mathcal{K}, t \in \mathcal{T}. \quad (\text{C.16})$$

$$x_{iit}^{-,k} \geq 0, \quad \forall i \in \mathcal{N}^k, l \in \mathcal{L}^k, k \in \mathcal{K}, t \in \mathcal{T}. \quad (\text{C.17})$$

$$x_{iit}^{+,k} \geq 0, \quad \forall i \in \mathcal{N}^k, l \in \mathcal{L}^k, k \in \mathcal{K}, t \in \mathcal{T}. \quad (\text{C.18})$$

$$0 \leq y_{it}^k \leq 1, \quad \forall i \in \mathcal{N}^k, k \in \mathcal{K}, t \in \mathcal{T}. \quad (\text{C.19})$$

$$0 \leq y_{ijt}^k \leq 1, \quad \forall (i, j) \in \mathcal{A}^k, k \in \mathcal{K}, t \in \mathcal{T}. \quad (\text{C.19.arc})$$

$$\alpha_{iwt}^k \in \{0,1\}, \forall i \in \mathcal{N}'^k, w \in \mathcal{W}^k, k \in \mathcal{K}, t \in \mathcal{T}. \quad (\text{C.20})$$

$$\alpha_{ijwt}^k \in \{0,1\}, \forall (i,j) \in \mathcal{A}'^k, w \in \mathcal{W}^k, k \in \mathcal{K}, t \in \mathcal{T}. \quad (\text{C.20.arc})$$

$$\beta_{iwt}^k \in \{0,1\}, \forall i \in \mathcal{N}'^k, w \in \mathcal{W}^k, k \in \mathcal{K}, t \in \mathcal{T}. \quad (\text{C.21})$$

$$\beta_{ijwt}^k \in \{0,1\}, \forall (i,j) \in \mathcal{A}'^k, w \in \mathcal{W}^k, k \in \mathcal{K}, t \in \mathcal{T}. \quad (\text{C.21.arc})$$

C.4.5. Equation descriptions

Table C1 summarizes and categorizes the equations. The equations are categorized as either objective functions, flow constraints, recovery constraints, scheduling constraints, interdependency constraints, or side constraints. Table C1 seeks to strike a balance between completeness and brevity by combining like equations.

Table C1. Summary of objective function and constraints for LiteBIIRM

Ref	Category	Description
C.1	Objective func.	Least cost recovery strategies. The first and second terms are the arc repair costs and arc assignment costs, the third and fourth terms are node repair costs and node assignment costs, and the fifth term is the flow cost.
C.2	Objective func.	Weighted operability of nodes and arcs, which represents a surrogate for mission impact or disruptive effect.
C.3	Objective func.	Weighted and combined multi-objective function using C.1 and C.2.
C.4	Flow constraints	Standard flow balance. Where slack variables representing unmet demand and surplus supply help balance the equation.
C.5 to C.7	Flow constraints	Restricts flow if starting node (C.5), ending node (C.6), and arc (C.7) is inoperable.
C.8, C.9, C.11	Recovery constraints	Ensures that a restored asset becomes operable (C.8), assets are only repaired once (C.9), and assets are repaired after sufficient processing time (C.11).
C.10 C.12	Scheduling constraints	Ensures that only one work crew is assigned per repair task (C.10) and that crews work on only one job at a time (C.12).
C.13 to C.15	Interdependency constraints	Child node operability depends on parent node's operability and coupling (C.13) and (C.14), and nodes are operable if demand is met (C.15).
C.16 to C.21	Side constraints	Flow variables are positive continuous, operability is continuous between 0 and 1, and assignment and repair variables are binary.

Appendix D. The Base Interdependent Infrastructure Recovery Model (BIIRM)

This appendix details the goals, assumptions, notation, and formulation for the complete BIIRM model as seen in part in Chapter 5.

D.1. BIIRM Goals

The goal of this model is to find optimal recovery strategies of disrupted interdependent infrastructure networks while balancing cost, disruption, and repair time. In order to accomplish this goal the model has three sub goals enumerated below.

1. Integrate network design and scheduling problems in order to model infrastructure recovery.
2. Incorporate 9 interdependency subtypes including 4 operational (i.e., physical, cyber, logical, and geospatial) and 5 restoration interdependency subtypes (i.e., traditional precedence, effectiveness precedence, options precedence, time-sensitive options, and geospatial repair).
3. Allow for and evaluate multiple complex interdependency relationships between node pairs simultaneously.

D.2. BIIRM Assumptions

The assumptions for the BIIRM may be categorized into network flow, scheduling, interdependency, and cost assumptions.

D.2.1. Network Flow Assumptions

- Each infrastructure network layer is composed of arcs and nodes, both of which are subject to failure and can be repaired or reconstructed.

- Each infrastructure network may flow one or more commodities. An example of a single commodity network is the drinking water network, which supplies potable water for consumption. An example of multicommodity flow is the transportation and emergency response layer which flows EMS, Police, Fire, and People as commodities.
- Each commodity flows through only one infrastructure network.
- Networks have a known supply and demand structure for all commodities associated with that given network.
- There is a known flow capacity for each arc in every infrastructure network, which is shared by all commodities flowing through a given network.
- A damaged node or arc is not operational until it is restored. Damage creates total inoperability, which is a simplification of reality.

D.2.2. Scheduling Assumptions

- When a recovery task is started it will be completed, before a work crew will be assigned to a different one. This means it is a non-preemptive environment.
- Recovery of nodes and arcs are assumed to be expedient and possible (i.e., no total losses). This also neglects the real processes of insurance claims, estimations, project bidding, material acquisition, project execution, and project closing which should follow any temporary repairs done during recovery operations.

- Additional tasks on or near nodes or arcs that are not directly related to repairing a damaged node are designated by a pseudo-node or pseudo-arc. An example is a power line inspection and deenergizing, which must be accomplished prior to downed tree removal and before the actual repairing of the power line.
- Work crews are skilled and proficient to handle any necessary repair in the assigned network layer.
- Sufficient materials are available for repair of assets.

D.2.3. Interdependency Assumptions

- Interdependencies, which are by definition bi-directional, are captured by capturing all uni-directional dependent relationships between infrastructure pairs (Sharkey et al. 2016).
- Operational interdependencies (i.e., physical, cyber, logical, and geographical) are known. This is a simplification of reality, since some interdependencies manifest themselves only in unique situations and are not generally known (National Infrastructure Advisory Council (NIAC) 2018).
- Operational interdependencies subtypes (i.e., physical, cyber, logical, or geospatial) are assumed to exist between node pairs and can be described based on a coupling strategy. Operational interdependency coupling of node pairs can be achieved at least four ways, including one-to-one, one-to-any, one-to-all, and one-to-many (González et al. 2016). Due to the binary nature of the operability variable only one-to-one, one-to-any, and one-to-all coupling strategies are

compatible with the BIIRM. Additional modifications are required to enable all coupling strategies. Coupling was removed in Chapter 3's reduced presentation of the BIIRM due to brevity.

- The operational interdependency geospatial subtype may be and is incorporated during damage scenario generation.
- Four of the five restoration interdependency subtypes identified by Sharkey et al. (2015) (i.e., traditional precedence, effectiveness precedence, options precedence, and time-sensitive options) are assumed to exist between nodes and arcs. This creates coupling strategies for restoration interdependencies of node-to-node (n2n), node-to-arc (n2a), arc-to-node (a2n), and arc-to-arc (a2a).
- The geospatial repair restoration interdependency subtype assumes the site preparation cost burden during a specific period of time is shared. This can be thought of as the cost of site preparation for co-located network components being shared between the networks. This is achieved by a cost being associated with each geographical region as a worst-case scenario (González et al. 2016).
- Interdependencies affect node operability. Multiple interdependency subtype connections between node pairs in different infrastructure networks can all influence node operability.

D.2.4. Cost Assumptions

- There is a known fixed cost of flowing a given commodity in a network during a certain time period. This is a simplification since costs in reality could depend on the amount of commodity flow during a time period.
- The reconstruction costs for each node and arc are known fixed costs for a given time period. This is a simplification of reality. Typically, repair costs are dependent on the severity of the damage and on the type of repair selected. They are also initially given as estimates, which may be high or low depending on the unforeseen site conditions and the experience of the estimator.
- Cost for recovery crew assignment and associated materials happens when work is assigned, not completed.

D.3. BIIRM Notation

This section lists the sets, parameters, and variables used in the BIIRM. The listing is alphabetical with symbols from the Latin alphabet first followed by the Greek alphabet. Unless otherwise explicitly stated the index t denotes “during time period $t \in \mathcal{T}$ ” where \mathcal{T} is the set of all time periods.

\mathcal{A} = overall set of arcs, indexed as (i, j) ;

\mathcal{A}^k = subset of arcs within a given infrastructure layer $k \in \mathcal{K}$;

\mathcal{A}' = overall set of damaged arcs;

\mathcal{A}'^k = subset of damaged arcs within a given layer $k \in \mathcal{K}$;

a_{wt}^k = cost of assigning work crew $w \in \mathcal{W}^k$;

b_{it}^k = supply or demand of commodity $l \in \mathcal{L}^k$ at node $i \in \mathcal{N}^k$;

c_{ijlt}^k = cost of flowing commodity $l \in \mathcal{L}^k$ through arc $(i, j) \in \mathcal{A}^k$;

e_i^k or e_{ij}^k = extended processing time for repair of node $i \in \mathcal{N}'^k$ or arc $(i, j) \in \mathcal{A}'^k$;

g_{ijs}^k or g_{is}^k = binary variable indicating if arc $(i, j) \in \mathcal{A}^k$ or node $i \in \mathcal{N}^k$ is in space $s \in \mathcal{S}$;

g_{st} = cost of geospatial site preparation of space $s \in \mathcal{S}$;

\mathcal{L} = overall set of commodities;

\mathcal{L}^k = subset of commodities able to flow within a given layer $k \in \mathcal{K}$;

\mathcal{N} = overall set of nodes, indexed as i ;

\mathcal{N}^k = subset of nodes within a given infrastructure layer $k \in \mathcal{K}$;

\mathcal{N}' = set of all damaged nodes;

\mathcal{N}'^k = subset of damaged nodes within a given layer $k \in \mathcal{K}$;

p_i^k or p_{ij}^k = normal processing time for repair of node $i \in \mathcal{N}'^k$ or arc $(i, j) \in \mathcal{A}'^k$;

q_{ijt}^k or q_{it}^k = cost of repair for recovery task at arc $(i, j) \in \mathcal{A}'^k$ or node $i \in \mathcal{N}'^k$;

\mathcal{S} = set of spaces;

u_{ijt}^k = capacity of arc $(i, j) \in \mathcal{A}^k$ shared by all commodities flowing along that arc;

\mathcal{W} = set of all work crews;

\mathcal{W}^k = subset of work crews able to perform tasks in infrastructure layer $k \in \mathcal{K}$;

x_{ijlt}^k = variable representing flow of commodity $l \in \mathcal{L}^k$ along arc $(i, j) \in \mathcal{A}^k$;

$x_{it}^{-,k}$ = slack variable representing unmet demand of commodity $l \in \mathcal{L}^k$ at node $i \in \mathcal{N}^k$;

$x_{it}^{+,k}$ = slack variable representing surplus of commodity $l \in \mathcal{L}^k$ at node $i \in \mathcal{N}^k$;

y_{ijt}^k or y_{it}^k = binary variable indicating if arc $(i, j) \in \mathcal{A}^k$ or node $i \in \mathcal{N}^k$ is operable;

z_{st} = binary variable indicating if a recovery task in space $s \in \mathcal{S}$ is assigned during time period $t \in \mathcal{T}$;

α_{ijwt}^k or α_{iwt}^k = binary variable indicating if work crew $w \in \mathcal{W}^k$ is assigned to a recovery task during time period $t \in \mathcal{T}$;

$\alpha_{ije wt}^k$ or $\alpha_{i_e wt}^k$ = binary variable indicating if work crew $w \in \mathcal{W}^k$ is assigned to a recovery task with extended processing time during time period $t \in \mathcal{T}$;

β_{ijwt}^k or β_{iwt}^k = binary variable indicating if work crew $w \in \mathcal{W}^k$ has completed the recovery task by the beginning of time period $t \in \mathcal{T}$;

$\gamma_{ii\psi t}^{k\bar{k}}$ = operational interdependency parameter based on parent-child node pairs $i \in \mathcal{N}_{i\psi\xi}^{k\bar{k}}$ with some operational interdependency type $\psi \in \Psi$;

$\theta_{ii}^{k\bar{k}}$ = node-to-node time-sensitive option deadline (other variations exist);

μ_A and μ_B = weighting parameter for cost objective and disruptive effect objective;

μ_{ijt}^k or μ_{it}^k = weighting parameter for arc $(i, j) \in \mathcal{A}'^k$ or node $i \in \mathcal{N}'^k$ at time period $t \in \mathcal{T}$;

Ξ = set of coupling strategies, indexed as ξ ;

Ψ = set of operational interdependency subtypes, indexed as ψ ;

D.4. BIIRM Formulation

The following is the full formulation of the BIIRM. Equations may have a suffix ascribed denoting a variation based on being arc-based instead of node-based (no suffix). A suffix is also used on all restoration interdependency constraints based on coupling of node-to-node (n2n), node-to-arc (n2a), arc-to-node (a2n), or arc-to-arc (a2a).

Additionally, an asterisk is used to denote modifications to previously listed equations if

including the applicable relationships. The formulation of the BIIRM was builds upon the work of González et al. (2016) and Sharkey et al. (2015).

D.4.1. Objective functions

$$\begin{aligned} \text{Cost Objective: } A = & \sum_{t \in \mathcal{T}} \left(\sum_{s \in \mathcal{S}} g_{st} z_{st} + \right. \\ & \sum_{k \in \mathcal{K}} \left(\sum_{w \in \mathcal{W}^k} \left(\sum_{(i,j) \in \mathcal{A}'^k} (q_{ijt}^k (\alpha_{ijwt}^k + \alpha_{ije wt}^k) + a_{wt}^k (p_{ij}^k \alpha_{ijwt}^k + e_{ij}^k \alpha_{ije wt}^k)) + \right. \right. \\ & \left. \left. \sum_{i \in \mathcal{N}'^k} (q_{it}^k (\alpha_{iwt}^k + \alpha_{ie wt}^k) + a_{wt}^k (p_i^k \alpha_{iwt}^k + e_i^k \alpha_{ie wt}^k)) \right) + \sum_{l \in \mathcal{L}^k} \sum_{(i,j) \in \mathcal{A}^k} c_{ijlt}^k x_{ijlt}^k \right). \end{aligned} \quad (\text{D.1})$$

$$\text{Disruption Objective: } B = \sum_{t \in \mathcal{T}} \sum_{k \in \mathcal{K}} \left(\sum_{i \in \mathcal{N}^k} \mu_{it}^k y_{it}^k + \sum_{(i,j) \in \mathcal{A}^k} \mu_{ijt}^k y_{ijt}^k \right). \quad (\text{D.2})$$

These two explicit objective functions also include a time index, thus incorporating repair time into the combined objective functions implicitly as follows.

$$\text{Minimize } \mu_A A - \mu_B B. \quad (\text{D.3})$$

Subject to the following constraints

D.4.2. Network flow and scheduling constraints

$$\sum_{j: (i,j) \in \mathcal{A}^k} x_{ijlt}^k - \sum_{j: (j,i) \in \mathcal{A}^k} x_{jilt}^k = b_{ilt}^k + x_{ilt}^{-,k} - x_{ilt}^{+,k}, \quad \forall i \in \mathcal{N}^k, l \in \mathcal{L}^k, k \in \mathcal{K}, t \in \mathcal{T}. \quad (\text{D.4})$$

$$\sum_{l \in \mathcal{L}^k} x_{ijlt}^k \leq u_{ijt}^k y_{it}^k, \quad \forall (i,j) \in \mathcal{A}^k, i \in \mathcal{N}^k, k \in \mathcal{K}, t \in \mathcal{T}. \quad (\text{D.5})$$

$$\sum_{l \in \mathcal{L}^k} x_{ijlt}^k \leq u_{ijt}^k y_{jt}^k, \quad \forall (i,j) \in \mathcal{A}^k, j \in \mathcal{N}^k, k \in \mathcal{K}, t \in \mathcal{T}. \quad (\text{D.6})$$

$$\sum_{l \in \mathcal{L}^k} x_{ijlt}^k \leq u_{ijt}^k y_{ijt}^k, \quad \forall (i,j) \in \mathcal{A}^k, k \in \mathcal{K}, t \in \mathcal{T}. \quad (\text{D.7})$$

$$y_{it}^k \leq \sum_{w \in \mathcal{W}^k} \sum_{\tau=1}^t \beta_{iwt}^k, \quad \forall i \in \mathcal{N}'^k, k \in \mathcal{K}, t \in \mathcal{T}. \quad (\text{D.8})$$

$$y_{ijt}^k \leq \sum_{w \in \mathcal{W}^k} \sum_{\tau=1}^t \beta_{ijw\tau}^k, \quad \forall (i,j) \in \mathcal{A}'^k, k \in \mathcal{K}, t \in \mathcal{T}. \quad (\text{D.8.arc})$$

$$\sum_{t \in \mathcal{T}} \sum_{w \in \mathcal{W}^k} \beta_{iwt}^k \leq 1, \quad \forall i \in \mathcal{N}'^k, k \in \mathcal{K}. \quad (\text{D.9})$$

$$\sum_{t \in \mathcal{T}} \sum_{w \in \mathcal{W}^k} \beta_{ijwt}^k \leq 1, \forall (i, j) \in \mathcal{A}'^k, k \in \mathcal{K}. \quad (\text{D.9.arc})$$

$$\sum_{t \in \mathcal{T}} \sum_{w \in \mathcal{W}^k} \alpha_{iwt}^k \leq 1, \forall i \in \mathcal{N}'^k, k \in \mathcal{K}. \quad (\text{D.10})$$

$$\sum_{t \in \mathcal{T}} \sum_{w \in \mathcal{W}^k} \alpha_{ijwt}^k \leq 1, \forall (i, j) \in \mathcal{A}'^k, k \in \mathcal{K}. \quad (\text{D.10.arc})$$

$$\beta_{iwt}^k \leq \sum_{\tau=1}^{\min[T, t-p_i^k]} \alpha_{iwt}^k, \forall i \in \mathcal{N}'^k, w \in \mathcal{W}^k, k \in \mathcal{K}, t \in \mathcal{T}. \quad (\text{D.11})$$

$$\beta_{ijwt}^k \leq \sum_{\tau=1}^{\min[T, t-p_{ij}^k]} \alpha_{ijw\tau}^k, \forall (i, j) \in \mathcal{A}'^k, w \in \mathcal{W}^k, k \in \mathcal{K}, t \in \mathcal{T}. \quad (\text{D.11.arc})$$

$$\sum_{\tau=1}^{\min[T, t+p_i^k-1]} \sum_{i \in \mathcal{N}'^k} \alpha_{iwt}^k + \sum_{\tau=1}^{\min[T, t+p_{ij}^k-1]} \sum_{(i, j) \in \mathcal{A}'^k} \alpha_{ijw\tau}^k \leq 1 + \sum_{\tau=p_{ij}^k+1}^t \sum_{i \in \mathcal{N}'^k} \beta_{iwt}^k + \sum_{\tau=p_{ij}^k+1}^t \sum_{(i, j) \in \mathcal{A}'^k} \beta_{ijw\tau}^k, \forall w \in \mathcal{W}^k, k \in \mathcal{K}, t \in \mathcal{T}. \quad (\text{D.12})$$

D.4.3. Operational interdependencies

$$\sum_{i \in \mathcal{N}_{i\psi\xi}^{k\tilde{k}}} \gamma_{i\psi\xi t}^{k\tilde{k}} y_{it}^k \geq y_{it}^{\tilde{k}}, \forall i \in \mathcal{N}^{\tilde{k}}, \tilde{k} \in \mathcal{K}, \psi \in \Psi, \xi \in \Xi, t \in \mathcal{T}. \quad (\text{D.13})$$

$$y_{it}^k b_{ilt}^k \geq b_{ilt}^k + x_{ilt}^{-,k}, \forall i \in \mathcal{N}_D^k, l \in \mathcal{L}^k, k \in \mathcal{K}, t \in \mathcal{T}. \quad (\text{D.14})$$

D.4.4. Restoration interdependencies

D.4.4.1. Traditional precedence

$$\sum_{\tau=1}^t \sum_{w \in \mathcal{W}^k} \beta_{iwt}^k \geq \sum_{w \in \mathcal{W}^{\tilde{k}}} \alpha_{iwt}^{\tilde{k}}, \forall (i, \tilde{i}) \in NTP, t \in \mathcal{T}. \quad (\text{D.15.n2n})$$

$$\sum_{\tau=1}^t \sum_{w \in \mathcal{W}^k} \beta_{ijw\tau}^k \geq \sum_{w \in \mathcal{W}^{\tilde{k}}} \alpha_{ijw\tau}^{\tilde{k}}, \forall (i, (\tilde{i}, \tilde{j})) \in NTP, t \in \mathcal{T}. \quad (\text{D.15.n2a})$$

$$\sum_{\tau=1}^t \sum_{w \in \mathcal{W}^k} \beta_{ijw\tau}^k \geq \sum_{w \in \mathcal{W}^{\tilde{k}}} \alpha_{iwt}^{\tilde{k}}, \forall ((i, j), \tilde{i}) \in ATP, t \in \mathcal{T}. \quad (\text{D.15.a2n})$$

$$\sum_{\tau=1}^t \sum_{w \in \mathcal{W}^k} \beta_{ijw\tau}^k \geq \sum_{w \in \mathcal{W}^{\tilde{k}}} \alpha_{ijw\tau}^{\tilde{k}}, \forall ((i, j), (\tilde{i}, \tilde{j})) \in ATP, t \in \mathcal{T}. \quad (\text{D.15.a2a})$$

$$1 - \frac{x_{ilt}^{-,k}}{-b_{ilt}^k} \geq \sum_{w \in \mathcal{W}^{\tilde{k}}} \alpha_{iwt}^{\tilde{k}}, \forall (i, \tilde{i}) \in NTP | b_{ilt}^k < 0, l \in \mathcal{L}^k, t \in \mathcal{T}. \quad (\text{D.16.n2n})$$

$$1 - \frac{x_{ilt}^{-,k}}{-b_{ilt}^k} \geq \sum_{w \in \mathcal{W}^{\tilde{k}}} \alpha_{ijw\tau}^{\tilde{k}}, \forall (i, (\tilde{i}, \tilde{j})) \in NTP | b_{ilt}^k < 0, l \in \mathcal{L}^k, t \in \mathcal{T}. \quad (\text{D.16.n2a})$$

$$\frac{1}{p_i^k} \sum_{\tau=t-p_i^k+1}^t \left(1 - \frac{x_{ilt}^{-k}}{-b_{ilt}^k}\right) \geq \sum_{w \in \mathcal{W}^k} \beta_{iwt}^k, \quad t = p_i^k, \dots, T, \forall (i, \tilde{i}) \in NTP | b_{ilt}^k <$$

$$0, l \in \mathcal{L}^k. \quad (D.17.n2n)$$

$$\frac{1}{p_{ij}^k} \sum_{\tau=t-p_{ij}^k+1}^t \left(1 - \frac{x_{ilt}^{-k}}{-b_{ilt}^k}\right) \geq \sum_{w \in \mathcal{W}^k} \beta_{ijwt}^k, \quad t = p_{ij}^k, \dots, T, \forall (i, (\tilde{i}, j)) \in NTP | b_{ilt}^k <$$

$$0, l \in \mathcal{L}^k. \quad (D.17.n2a)$$

D.4.4.2. Effectiveness precedence

$$\sum_{t \in \mathcal{T}} \sum_{w \in \mathcal{W}^k} (\alpha_{iwt}^k + \alpha_{i_e w t}^k) \leq 1, \quad \forall i \in \mathcal{N}'^k, k \in \mathcal{K}. \quad (D.10^*)$$

$$\sum_{t \in \mathcal{T}} \sum_{w \in \mathcal{W}^k} (\alpha_{ijwt}^k + \alpha_{i_j e w t}^k) \leq 1, \quad \forall (i, j) \in \mathcal{A}'^k, k \in \mathcal{K}. \quad (D.10^*.arc)$$

$$\beta_{iwt}^k \leq \sum_{\tau=1}^{\min[T, t-p_i^k]} \alpha_{i w \tau}^k + \sum_{\tau=1}^{\min[T, t-e_i^k]} \alpha_{i_e w \tau}^k, \quad \forall i \in \mathcal{N}'^k, (\tilde{i}, i) \in$$

$$NEP, ((\tilde{i}, j), i) \in AEP, w \in \mathcal{W}^k, k \in \mathcal{K}, t \in \mathcal{T}. \quad (D.11^*)$$

$$\beta_{ijwt}^k \leq \sum_{\tau=1}^{\min[T, t-p_{ij}^k]} \alpha_{i j w \tau}^k + \sum_{\tau=1}^{\min[T, t-e_{ij}^k]} \alpha_{i_j e w \tau}^k, \quad \forall (i, j) \in \mathcal{A}'^k, (\tilde{i}, (i, j)) \in$$

$$NEP, ((\tilde{i}, j), (i, j)) \in AEP, w \in \mathcal{W}^k, k \in \mathcal{K}, t \in \mathcal{T}. \quad (D.11^*.arc)$$

$$\begin{aligned} & \sum_{\tau=1}^{\min[T, t+p_i^k-1]} \sum_{i \in \mathcal{N}'^k} \alpha_{i w \tau}^k + \sum_{\tau=1}^{\min[T, t+p_{ij}^k-1]} \sum_{(i, j) \in \mathcal{A}'^k} \alpha_{i j w \tau}^k + \\ & \sum_{\tau=1}^{\min[T, t+e_i^k-1]} \sum_{\left(\begin{array}{l} (i, i) \in NEP, \\ ((\tilde{i}, j), i) \in AEP \end{array} \right)} \alpha_{i_e w \tau}^k + \sum_{\tau=1}^{\min[T, t+e_{ij}^k-1]} \sum_{\left(\begin{array}{l} (i, (i, j)) \in NEP, \\ ((\tilde{i}, j), (i, j)) \in AEP \end{array} \right)} \alpha_{i_j e w \tau}^k \leq 1 + \\ & \sum_{\tau=p_i^k+1}^t \sum_{i \in \mathcal{N}'^k} \beta_{i w \tau}^k + \sum_{\tau=p_{ij}^k+1}^t \sum_{(i, j) \in \mathcal{A}'^k} \beta_{i j w \tau}^k, \quad \forall w \in \mathcal{W}^k, k \in \mathcal{K}, t \in \mathcal{T}. \quad (D.12^*) \end{aligned}$$

$$\sum_{\tau=1}^t \sum_{w \in \mathcal{W}^k} \beta_{i w \tau}^k \leq \sum_{\tau=1}^t \sum_{w \in \mathcal{W}^k} \alpha_{i_e w \tau}^k + \sum_{\tau=1}^{\min[T, t-p_i^k]} \sum_{w \in \mathcal{W}^k} \alpha_{i w \tau}^k, \quad \forall (i, \tilde{i}) \in$$

$$NEP, t \in \mathcal{T}. \quad (D.18.n2n)$$

$$\sum_{\tau=1}^t \sum_{w \in \mathcal{W}^k} \beta_{i w \tau}^k \leq \sum_{\tau=1}^t \sum_{w \in \mathcal{W}^k} \alpha_{i_j e w \tau}^k + \sum_{\tau=1}^{\min[T, t-p_i^k]} \sum_{w \in \mathcal{W}^k} \alpha_{i w \tau}^k,$$

$$\forall (i, (\tilde{i}, j)) \in NEP, t \in \mathcal{T}. \quad (D.18.n2a)$$

$$\sum_{\tau=1}^t \sum_{w \in \mathcal{W}^k} \beta_{ijw\tau}^k \leq \sum_{\tau=1}^t \sum_{w \in \mathcal{W}^{\bar{k}}} \alpha_{i_e w \tau}^{\bar{k}} + \sum_{\tau=1}^{\min[T, t-p_{ij}^k]} \sum_{w \in \mathcal{W}^k} \alpha_{ijw\tau}^k, \quad \forall ((i, j), \tilde{i}) \in AEP, t \in \mathcal{T}. \quad (D.18.a2n)$$

$$\sum_{\tau=1}^t \sum_{w \in \mathcal{W}^k} \beta_{ijw\tau}^k \leq \sum_{\tau=1}^t \sum_{w \in \mathcal{W}^{\bar{k}}} \alpha_{i_j e w \tau}^{\bar{k}} + \sum_{\tau=1}^{\min[T, t-p_{ij}^k]} \sum_{w \in \mathcal{W}^k} \alpha_{ijw\tau}^k, \quad \forall ((i, j), (\tilde{i}, \tilde{j})) \in AEP, t \in \mathcal{T}. \quad (D.18.a2a)$$

$$1 - \frac{x_{ilt}^{-,k}}{-b_{ilt}^k} \geq \sum_{w \in \mathcal{W}^{\bar{k}}} \alpha_{iwt}^{\bar{k}}, \quad \forall (i, \tilde{i}) \in NEP | b_{ilt}^k < 0, l \in \mathcal{L}^k, t \in \mathcal{T}. \quad (D.19.n2n)$$

$$1 - \frac{x_{ilt}^{-,k}}{-b_{ilt}^k} \geq \sum_{w \in \mathcal{W}^{\bar{k}}} \alpha_{i_j w t}^{\bar{k}}, \quad \forall (i, (\tilde{i}, \tilde{j})) \in NEP | b_{ilt}^k < 0, l \in \mathcal{L}^k, t \in \mathcal{T}. \quad (D.19.n2a)$$

D.4.4.3. Options precedence

$$\sum_{\tau=1}^t \sum_{w \in \mathcal{W}^k} \sum_{(i, \tilde{i}) \in NOP} \beta_{iwt}^k \geq \sum_{w \in \mathcal{W}^{\bar{k}}} \alpha_{iwt}^{\bar{k}}, \quad \forall (i, \tilde{i}) \in NOP, t \in \mathcal{T}. \quad (D.20.n2n)$$

$$\sum_{\tau=1}^t \sum_{w \in \mathcal{W}^k} \sum_{(i, (\tilde{i}, \tilde{j})) \in NOP} \beta_{iwt}^k \geq \sum_{w \in \mathcal{W}^{\bar{k}}} \alpha_{i_j w t}^{\bar{k}}, \quad \forall (i, (\tilde{i}, \tilde{j})) \in NOP, t \in \mathcal{T}. \quad (D.20.n2a)$$

$$\sum_{\tau=1}^t \sum_{w \in \mathcal{W}^k} \sum_{((i, j), \tilde{i}) \in AOP} \beta_{ijw\tau}^k \geq \sum_{w \in \mathcal{W}^{\bar{k}}} \alpha_{iwt}^{\bar{k}}, \quad \forall ((i, j), \tilde{i}) \in AOP, t \in \mathcal{T}. \quad (D.20.a2n)$$

$$\sum_{\tau=1}^t \sum_{w \in \mathcal{W}^k} \sum_{((i, j), (\tilde{i}, \tilde{j})) \in AOP} \beta_{ijw\tau}^k \geq \sum_{w \in \mathcal{W}^{\bar{k}}} \alpha_{i_j w t}^{\bar{k}}, \quad \forall ((i, j), (\tilde{i}, \tilde{j})) \in AOP, t \in \mathcal{T}. \quad (D.20.a2a)$$

$$1 - \frac{x_{ilt}^{-,k}}{-b_{ilt}^k} \geq \sum_{w \in \mathcal{W}^{\bar{k}}} \alpha_{iwt}^{\bar{k}}, \quad \forall (i, \tilde{i}) \in NOP | b_{ilt}^k < 0, l \in \mathcal{L}^k, t \in \mathcal{T}. \quad (D.21.n2n)$$

$$1 - \frac{x_{ilt}^{-,k}}{-b_{ilt}^k} \geq \sum_{w \in \mathcal{W}^{\bar{k}}} \alpha_{i_j w t}^{\bar{k}}, \quad \forall (i, (\tilde{i}, \tilde{j})) \in NOP | b_{ilt}^k < 0, l \in \mathcal{L}^k, t \in \mathcal{T}. \quad (D.21.n2a)$$

$$\frac{1}{p_i^{\bar{k}}} \sum_{\tau=t-p_i^{\bar{k}}+1}^t \left(1 - \frac{x_{ilt}^{-,k}}{-b_{ilt}^k} \right) \geq \sum_{w \in \mathcal{W}^{\bar{k}}} \beta_{iwt}^{\bar{k}}, \quad t = p_i^{\bar{k}}, \dots, T, \forall (i, \tilde{i}) \in NOP | b_{ilt}^k < 0, l \in \mathcal{L}^k. \quad (D.22.n2n)$$

$$\frac{1}{p_{ij}^k} \sum_{\tau=t-p_{ij}^k+1}^t \left(1 - \frac{x_{ilt}^{-k}}{-b_{ilt}^k}\right) \geq \sum_{w \in \mathcal{W}^k} \beta_{ijwt}^k, \quad t = p_{ij}^k, \dots, T, \forall (i, (\tilde{i}, j)) \in \text{NOP} | b_{ilt}^k <$$

$$0, l \in \mathcal{L}^k. \quad (\text{D.22.n2a})$$

D.4.4.4. Time sensitive options

$$y_{it}^k + \sum_{\tau=1}^{\theta_{ii}^{k\tilde{k}}} \sum_{w \in \mathcal{W}^k} \beta_{iwt}^k \geq 1, \quad t = \theta_{ii}^{k\tilde{k}}, \dots, T, \forall (i, \tilde{i}) \in \text{NTS}. \quad (\text{D.23.n2n})$$

$$y_{it}^k + \sum_{\tau=1}^{\theta_{ij}^{k\tilde{k}}} \sum_{w \in \mathcal{W}^k} \beta_{ijwt}^k \geq 1, \quad t = \theta_{ij}^{k\tilde{k}}, \dots, T, \forall (i, (\tilde{i}, j)) \in \text{NTS}. \quad (\text{D.23.n2a})$$

$$y_{ijt}^k + \sum_{\tau=1}^{\theta_{ij\tilde{i}}^{k\tilde{k}}} \sum_{w \in \mathcal{W}^k} \beta_{iwt}^k \geq 1, \quad t = \theta_{ij\tilde{i}}^{k\tilde{k}}, \dots, T, \forall ((i, j), \tilde{i}) \in \text{ATS}. \quad (\text{D.23.a2n})$$

$$y_{ijt}^k + \sum_{\tau=1}^{\theta_{ij\tilde{i}}^{k\tilde{k}}} \sum_{w \in \mathcal{W}^k} \beta_{ijwt}^k \geq 1, \quad t = \theta_{ij\tilde{i}}^{k\tilde{k}}, \dots, T, \forall ((i, j), (\tilde{i}, j)) \in \text{ATS}. \quad (\text{D.23.a2a})$$

$$\sum_{w \in \mathcal{W}^k} \alpha_{iwt}^k = 0, \quad t = 1, \dots, \theta_{ii}^{k\tilde{k}} - p_i^k - 1, \forall (i, \tilde{i}) \in \text{NTS}. \quad (\text{D.24.n2n})$$

$$\sum_{w \in \mathcal{W}^k} \alpha_{iwt}^k = 0, \quad t = 1, \dots, \theta_{ij}^{k\tilde{k}} - p_{ij}^k - 1, \forall (i, (\tilde{i}, j)) \in \text{NTS}. \quad (\text{D.24.n2a})$$

$$\sum_{w \in \mathcal{W}^k} \alpha_{ijwt}^k = 0, \quad t = 1, \dots, \theta_{ij\tilde{i}}^{k\tilde{k}} - p_i^k - 1, \forall ((i, j), \tilde{i}) \in \text{ATS}. \quad (\text{D.24.a2n})$$

$$\sum_{w \in \mathcal{W}^k} \alpha_{ijwt}^k = 0, \quad t = 1, \dots, \theta_{ij\tilde{i}}^{k\tilde{k}} - p_{ij}^k - 1, \forall ((i, j), (\tilde{i}, j)) \in \text{ATS}. \quad (\text{D.24.a2a})$$

D.4.4.5. Geospatial repair

$$\sum_{w \in \mathcal{W}^k} g_{is}^k (\alpha_{iwt}^k + \alpha_{i_e wt}^k) \leq z_{st}, \quad \forall i \in \mathcal{N}^k, s \in \mathcal{S}, k \in \mathcal{K}, t \in \mathcal{T}. \quad (\text{D.25})$$

$$\sum_{w \in \mathcal{W}^k} g_{ijs}^k (\alpha_{ijwt}^k + \alpha_{ij_e wt}^k) \leq z_{st}, \quad \forall (i, j) \in \mathcal{A}^k, s \in \mathcal{S}, k \in \mathcal{K}, t \in \mathcal{T}. \quad (\text{D.25.arc})$$

D.4.5. Side constraints

$$x_{ijlt}^k \geq 0, \quad \forall (i, j) \in \mathcal{A}^k, l \in \mathcal{L}^k, k \in \mathcal{K}, t \in \mathcal{T}. \quad (\text{D.26})$$

$$x_{ilt}^{-k} \geq 0, \quad \forall i \in \mathcal{N}^k, l \in \mathcal{L}^k, k \in \mathcal{K}, t \in \mathcal{T}. \quad (\text{D.27})$$

$$x_{ilt}^{+k} \geq 0, \quad \forall i \in \mathcal{N}^k, l \in \mathcal{L}^k, k \in \mathcal{K}, t \in \mathcal{T}. \quad (\text{D.28})$$

$$y_{it}^k \in \{0,1\}, \forall i \in \mathcal{N}^k, k \in \mathcal{K}, t \in \mathcal{T}. \quad (\text{D.29})$$

$$y_{ijt}^k \in \{0,1\}, \forall (i,j) \in \mathcal{A}^k, k \in \mathcal{K}, t \in \mathcal{T}. \quad (\text{D.29.arc})$$

$$\alpha_{iwt}^k \in \{0,1\}, \forall i \in \mathcal{N}'^k, w \in \mathcal{W}^k, k \in \mathcal{K}, t \in \mathcal{T}. \quad (\text{D.30})$$

$$\alpha_{ijwt}^k \in \{0,1\}, \forall (i,j) \in \mathcal{A}'^k, w \in \mathcal{W}^k, k \in \mathcal{K}, t \in \mathcal{T}. \quad (\text{D.30.arc})$$

$$\alpha_{i_e wt}^k \in \{0,1\}, \forall (i, \tilde{i}), (i, (\tilde{i}, j)) \in \text{NEP}, w \in \mathcal{W}^k, k \in \mathcal{K}, t \in \mathcal{T}. \quad (\text{D.31})$$

$$\alpha_{i_j e wt}^k \in \{0,1\}, \forall ((i,j), \tilde{i}), ((i,j), (\tilde{i}, j)) \in \text{AEP}, w \in \mathcal{W}^k, k \in \mathcal{K}, t \in \mathcal{T}. \quad (\text{D.31.arc})$$

$$\beta_{iwt}^k \in \{0,1\}, \forall i \in \mathcal{N}'^k, w \in \mathcal{W}^k, k \in \mathcal{K}, t \in \mathcal{T}. \quad (\text{D.32})$$

$$\beta_{ijwt}^k \in \{0,1\}, \forall (i,j) \in \mathcal{A}'^k, w \in \mathcal{W}^k, k \in \mathcal{K}, t \in \mathcal{T}. \quad (\text{D.32.arc})$$

$$z_{st} \in \{0,1\}, \forall s \in \mathcal{S}, t \in \mathcal{T}. \quad (\text{D.33})$$

D.4.6. Equation descriptions

Table D1 summarizes and categorizes the equations. The equations are categorized as either objective functions, flow constraints, recovery constraints, scheduling constraints, interdependency constraints, or side constraints. Table D1 seeks to strike a balance between completeness and brevity by combining like equations.

Table D1. Summary of objective function and constraints for BIIRM

Ref	Category	Description
D.1	Objective func.	Least cost recovery strategies. The first term is the site preparation cost, the second and third terms are arc repair costs, the fourth and fifth terms are arc assignment costs, the sixth and seventh terms are node repair costs, the eighth and ninth terms are node assignment costs, and the tenth term is the flow cost.
D.2	Objective func.	Weighted operability of nodes and arcs, which represents a surrogate for mission impact or disruptive effect.
D.3	Objective func.	Weighted and combined multiobjective function using C.1 and C.2.
D.4	Flow constraints	Standard flow balance. Where slack variables representing unmet demand and surplus supply help balance the equation.
D.5 to D.7	Flow constraints	Restricts flow if starting node (C.5), ending node (C.6), and arc (C.7) is inoperable.
D.8, D.9, D.11	Recovery constraints	Ensures that a restored asset becomes operable (C.8), assets are only repaired once (C.9), and assets are repaired after sufficient processing time (C.11).
D.10 D.12	Scheduling constraints	Ensures that only one work crew is assigned per repair task (C.10) and that crews work on only one job at a time (C.12).
D.13, D.14	Interdependency constraints	Child node operability depends on parent node's operability (C.13) and nodes are operable if demand is met (C.14).
D.15 to D.17	Interdependency constraints	Traditional precedence completion order (C.15), assignment requires met demand (C.16), and sustainment (C.17).
D.18, D.19	Interdependency constraints	Effectiveness precedence completion order (C.18) and traditional assignment demand (C.19).
D.20 to D.22	Interdependency constraints	Options precedence completion order (C.20), assignment requires met demand (C.21), and sustainment (C.22).
D.23, D.24	Interdependency constraints	Time-sensitive options completion requirement (C.23) and restriction of assignment until deadline (C.24).
D.25	Interdependency constraints	Geospatial repair of nodes and arcs, which can enable cost savings for co-located work.
D.26 to D.33	Side constraints	Flow variables are positive continuous while assignment, repair, operability, and location variables are binary.

Appendix E. The Flexible Team Base

Interdependent Infrastructure Recovery Model (tmBIIRM)

This appendix details the additions and modifications to the goals, assumptions, notation, formulation, and computer code of the BIIRM which are associated with the complete tmBIIRM model as seen in part in Chapter 6.

E.1. tmBIIRM Goals

The goal of tmBIIRM maintains the primary goal and subgoals of the BIIRM to find optimal recovery strategies of disrupted interdependent infrastructure networks while balancing cost, disruption, and repair time. However, the tmBIIRM adds three additional subgoals in order to incorporate the elements of flexible teaming structures.

1. Integrate varying knowledge, skill, and abilities among work crew members, which could impact team composition and restoration effectiveness.
2. Ability for a work crew manager to assign more than one work crew to a task to realize efficiency benefits.
3. Allow for starting and stopping of restoration activities, thus creating a preemptive environment.

Three observations from academic literature and USAF initiatives motivates this exploration. First, Ouyang (2014) identified that no network-flow based models evaluated were able to “[inform] organizational and administrative structure to increase response and coordination of restoration activities.” An output of the tmBIIRM is a coordinated schedule of restoration activities and a schedule of work crew teaming. Second, the United States Air Force is seeking to improve the way they educate and train personnel to achieve multi-skilled Airmen (Roberson and Stafford 2017). An input of the tmBIIRM is

a skill matrix, which can be altered to evaluate the impact of varying and multiple skill sets to system recovery. Third, the United States Air Force Civil Engineer Enterprise has an effort entitled “Revitalizing Civil Engineer Squadrons” to more appropriately train, equip, and resource squadrons to enhance resiliency (United States Air Force (A4) 2020). The tmBIIRM improves modeling and simulation of teams’ impact on recovery operations, which is a direct element of resilient infrastructure and resilient personnel.

E.2. tmBIIRM Assumptions

The majority of the assumptions for the BIIRM remain in effect for the tmBIIRM. This section details the exceptions. To most concisely provide this information the assumptions being modified or challenged from the BIIRM are listed followed by the updated assumptions for the tmBIIRM. Both a tag of BIIRM or tmBIIRM at the beginning of the bulleted items helps identify which model the assumption is valid for. This is also done visually with the original assumption from the BIIRM listed at the first indentation level and those modified for the tmBIIRM at the second indentation level.

- (BIIRM) Work crews are skilled and proficient to handle any necessary repair in the assigned network layer.
 - (tmBIIRM) Work crew personnel have varying levels of knowledge, skill, and abilities which can be roughly classified as beginner, intermediate, and advanced skills.
 - (tmBIIRM) Skill level affects the efficiency of restoration activities where beginner skill level yields extended processing time, intermediate skill level yields normal processing time, and advanced skill level yields

shortened processing time. While this is a generalization, it reflects a closer approximation of reality that integrates skill level into task processing time.

- (tmBIIRM) Certain tasks require specific training, skills, and abilities. Personnel are able to support efforts across infrastructure systems so long as their knowledge, skills, and abilities match the required restoration activities.
- (BIIRM) Restoration activities may only be assigned to one work crew.
 - (tmBIIRM) Work crews may be assigned to the same restoration activity which will impact the processing time of the task.
 - (tmBIIRM) The effect on the processing time is restoration activity specific. There are circumstances when increased personnel speed up the processing time, circumstances that don't speed up the processing time, and circumstances where additional personnel slow down the processing time of a task.
- (BIIRM) When a recovery task is started it will be completed before a work crew will be assigned to a different one. This means it is a non-preemptive environment.
 - (tmBIIRM) Restoration tasks may be started and stopped as needed. This creates a preemptive environment.
 - (tmBIIRM) Progress of a restoration activity will not be lost if a task is stopped and restoration activities may continue from the point of stopped progress with no additional penalty.

- (BIIRM) Cost for repair and recovery crew assignment with associated materials happens when work is assigned, not completed.
 - (tmBIIRM) Repair costs are summed at the completion of a repair, but assignment costs are based on assigned personnel per manhour.

E.3. tmBIIRM Notation

This section lists the sets, parameters, and variables used in the tmBIIRM. The listing is alphabetical with symbols from the Latin alphabet first followed by the Greek alphabet. Unless otherwise explicitly stated the index t denotes “during time period $t \in \mathcal{T}$ ” where \mathcal{T} is the set of all time periods.

\mathcal{A} = overall set of arcs, indexed as (i, j) ;

\mathcal{A}^k = subset of arcs within a given infrastructure layer $k \in \mathcal{K}$;

\mathcal{A}' = overall set of damaged arcs;

\mathcal{A}'^k = subset of damaged arcs within a given layer $k \in \mathcal{K}$;

$a_{\pi t}$ = hourly rate cost of assigning personnel $\pi \in \Pi$ at time period $t \in \mathcal{T}$;

b_{ilt}^k = supply or demand of commodity $l \in \mathcal{L}^k$ at node $i \in \mathcal{N}^k$;

c_{ijlt}^k = cost of flowing commodity $l \in \mathcal{L}^k$ through arc $(i, j) \in \mathcal{A}^k$;

e_{if}^k or e_{ijf}^k = extended processing time in manhours for repair of node $i \in \mathcal{N}^k$ or arc $(i, j) \in \mathcal{A}'^k$ requiring skill $f \in \mathcal{F}$;

$E_{\pi f}$ = parameter indicating the experience level of personnel $\pi \in \Pi$ based on the skill set $f \in \mathcal{F}$. This serves as both an indication of the existence of a given skill set for a specific personnel $\pi \in \Pi$ and embodies the concept of varying skill levels. For example, a master carpentry worker with novice skills in electrical work and no skill in plumbing may have

an $E_{\pi f} = 1.25, 0.75,$ and 0 for carpentry, electrical, and plumbing work respectively.

This parameter is tunable by the modeler and is specific to each individual worker and should typically take a value between 0 and 2 , with 2 representing a worker's efficiency being double the standard or normal efficiency of 1 ;

\mathcal{F} = A set of knowledge, skills, and abilities that are required for restoration tasks, indexed as $f = \{1, \dots, F\}$. This generally can parallel the infrastructure systems – plumbing in water network, but may include other things or finer granularity – welding in water network vs. welding in liquid fuels network;

g_{ijs}^k or g_{is}^k = binary variable indicating if arc $(i, j) \in \mathcal{A}^k$ or node $i \in \mathcal{N}^k$ is in space $s \in \mathcal{S}$;

g_{st} = cost of geospatial site preparation of space $s \in \mathcal{S}$;

\mathcal{L} = overall set of commodities;

\mathcal{L}^k = subset of commodities able to flow within a given layer $k \in \mathcal{K}$;

\mathcal{N} = overall set of nodes, indexed as i ;

\mathcal{N}^k = subset of nodes within a given infrastructure layer $k \in \mathcal{K}$;

\mathcal{N}' = set of all damaged nodes;

\mathcal{N}'^k = subset of damaged nodes within a given layer $k \in \mathcal{K}$;

p_{if}^k or p_{ijf}^k = normal processing time in manhours for repair of node $i \in \mathcal{N}'^k$ or arc

$(i, j) \in \mathcal{A}'^k$ requiring skill set $f \in \mathcal{F}$;

q_{ijt}^k or q_{it}^k = cost of repair for recovery task at arc $(i, j) \in \mathcal{A}'^k$ or node $i \in \mathcal{N}'^k$;

\mathcal{S} = set of spaces;

u_{ijt}^k = capacity of arc $(i, j) \in \mathcal{A}^k$ shared by all commodities flowing along that arc;

\mathcal{W} = set of all work crews, indexed as $w = \{1, \dots, W\}$, where $W \leq P/2$ since all work crews must have at least two people in them;

x_{ijlt}^k = variable representing flow of commodity $l \in \mathcal{L}^k$ along arc $(i, j) \in \mathcal{A}^k$;

$x_{ilt}^{-,k}$ = slack variable representing unmet demand of commodity $l \in \mathcal{L}^k$ at node $i \in \mathcal{N}^k$;

$x_{ilt}^{+,k}$ = slack variable representing surplus of commodity $l \in \mathcal{L}^k$ at node $i \in \mathcal{N}^k$;

y_{ijt}^k or y_{it}^k = binary variable indicating if arc $(i, j) \in \mathcal{A}^k$ or node $i \in \mathcal{N}^k$ is operable;

z_{st} = binary variable indicating if a recovery task in space $s \in \mathcal{S}$ is assigned during time period $t \in \mathcal{T}$;

$Z_{\pi wt}$ = binary variable that is equal to 1 if personnel $\pi \in \Pi$ is assigned to work crew $w \in \mathcal{W}$ in time period $t \in \mathcal{T}$. Therefore, the number of personnel on a given work crew $w \in \mathcal{W}$ in time period $t \in \mathcal{T}$ is equal to $n_{wt} = \sum_{\pi \in \Pi} Z_{\pi wt}$;

α_{ijwt}^k or α_{iwt}^k = variable indicating the number of manhours work crew $w \in \mathcal{W}$ is assigned to a recovery task at arc $(i, j) \in \mathcal{A}^k$ or node $i \in \mathcal{N}^k$;

$\alpha_{ije wt}^k$ or $\alpha_{i_e wt}^k$ = variable indicating the number of extended processing time manhours work crew $w \in \mathcal{W}$ is assigned to a recovery task with extended processing time during time period $t \in \mathcal{T}$;

β_{ijt}^k or β_{it}^k = binary variable equal to 1 if recovery task has been completed by the beginning of time period $t \in \mathcal{T}$ and 0 otherwise;

$\gamma_{i\bar{i}\psi\xi t}^{k\bar{k}}$ = operational interdependency parameter based on parent-child node pairs $i \in$

$\mathcal{N}^{k\bar{k}}$ with some operational interdependency type $\psi \in \Psi$ and coupling strategy $\xi \in \Xi$;

Δ_{ift}^k or Δ_{ijft}^k = variable amount of work completed on restoration activity requiring skill set $f \in \mathcal{F}$ by the end of time period $t \in \mathcal{T}$;

$\eta_{\pi ft}$ = variable indicating what percentage of time personnel $\pi \in \Pi$ is engaged in repair work utilizing skill set $f \in \mathcal{F}$ within time period $t \in \mathcal{T}$;

$\theta_{ii}^{k\bar{k}}$ = node-to-node time-sensitive option deadline (other variations exist to include $\theta_{ij}^{k\bar{k}}$, $\theta_{ij\bar{i}}$, and $\theta_{ij\bar{j}}$);

Θ_{ift}^k or Θ_{ijft}^k = variable amount representing the effective time at a restoration activity requiring skill set $f \in \mathcal{F}$ by the end of time period $t \in \mathcal{T}$ based on work crews working at a normal processing time;

Θ_{ieft}^k or Θ_{ijeft}^k = variable amount representing the effective time at a restoration activity requiring skill set $f \in \mathcal{F}$ by the end of time period $t \in \mathcal{T}$ based on work crews working at an extended processing time;

μ_A and μ_B = weighting parameter for cost objective and disruptive effect objective;

μ_{ijt}^k or μ_{it}^k = weighting parameter for arc $(i, j) \in \mathcal{A}^k$ or node $i \in \mathcal{N}^k$ at time period $t \in \mathcal{T}$;

Ξ = set of coupling strategies, indexed as ξ ;

Π = set of workers or personnel that can be assigned to a work crew, indexed as $\pi = \{1, \dots, P\}$;

ϕ_i^k or ϕ_{ij}^k = number of skill sets associated with the restoration activity. An example of this is a recovery task $i \in \mathcal{N}^k$ requiring some plumbing, electrical, and carpentry work would have a $\phi_i^k = 3$;

Ψ = set of operational interdependency subtypes, indexed as ψ ;

Ω = parameter designating the amount of hours in a time period (e.g., 8 hour work shifts, 12 hour half days, etc.);

E.4. tmBIIRM Formulation

The following is the full formulation of the tmBIIRM. Equations may have a suffix ascribed denoting a variation based on being arc-based instead of node-based (no suffix). A suffix is also used on all restoration interdependency constraints based on coupling of node-to-node (n2n), node-to-arc (n2a), arc-to-node (a2n), or arc-to-arc (a2a). Additionally, an asterisk is used to denote modifications to previously listed equations if including the applicable relationships. The formulation of the tmBIIRM builds upon the work of González et al. (2016) and Sharkey et al. (2015).

E.4.1. Objective functions

$$\text{Cost Objective: } A = \sum_{t \in \mathcal{T}} \left(\sum_{s \in \mathcal{S}} g_{st} z_{st} + \sum_{w \in \mathcal{W}} \sum_{\pi \in \Pi} a_{\pi t} \Omega Z_{\pi w t} + \sum_{k \in \mathcal{K}} \left(\sum_{(i,j) \in \mathcal{A}^k} q_{ijt}^k \beta_{ijt}^k + \sum_{i \in \mathcal{N}^k} q_{it}^k \beta_{it}^k + \sum_{l \in \mathcal{L}^k} \sum_{(i,j) \in \mathcal{A}^k} c_{ijlt}^k x_{ijlt}^k \right) \right). \quad (\text{E.1})$$

$$\text{Disruption Objective: } B = \sum_{t \in \mathcal{T}} \sum_{k \in \mathcal{K}} \left(\sum_{i \in \mathcal{N}^k} \mu_{it}^k y_{it}^k + \sum_{(i,j) \in \mathcal{A}^k} \mu_{ijt}^k y_{ijt}^k \right). \quad (\text{E.2})$$

These two explicit objective functions also include a time index, thus incorporating repair time into the combined objective functions implicitly as follows.

$$\text{Minimize } \mu_A A - \mu_B B. \quad (\text{E.3})$$

Subject to the following constraints

E.4.2. Network flow and scheduling constraints

$$\sum_{j:(i,j) \in \mathcal{A}^k} x_{ijlt}^k - \sum_{j:(j,i) \in \mathcal{A}^k} x_{jilt}^k = b_{ilt}^k + x_{ilt}^{-,k} - x_{ilt}^{+,k}, \quad \forall i \in \mathcal{N}^k, l \in \mathcal{L}^k, k \in \mathcal{K}, t \in \mathcal{T}. \quad (\text{E.4})$$

$$\sum_{l \in \mathcal{L}^k} x_{ijlt}^k \leq u_{ijlt}^k y_{it}^k, \quad \forall (i,j) \in \mathcal{A}^k, i \in \mathcal{N}^k, k \in \mathcal{K}, t \in \mathcal{T}. \quad (\text{E.5})$$

$$\sum_{l \in \mathcal{L}^k} x_{ijlt}^k \leq u_{ijt}^k y_{jt}^k, \quad \forall (i, j) \in \mathcal{A}^k, j \in \mathcal{N}^k, k \in \mathcal{K}, t \in \mathcal{T}. \quad (\text{E.6})$$

$$\sum_{l \in \mathcal{L}^k} x_{ijlt}^k \leq u_{ijt}^k y_{ijt}^k, \quad \forall (i, j) \in \mathcal{A}^k, k \in \mathcal{K}, t \in \mathcal{T}. \quad (\text{E.7})$$

$$y_{it}^k \leq \sum_{\tau=1}^t \beta_{it}^k, \quad \forall i \in \mathcal{N}'^k, k \in \mathcal{K}, t \in \mathcal{T}. \quad (\text{E.8})$$

$$y_{ijt}^k \leq \sum_{\tau=1}^t \beta_{ij\tau}^k, \quad \forall (i, j) \in \mathcal{A}'^k, k \in \mathcal{K}, t \in \mathcal{T}. \quad (\text{E.8.arc})$$

$$\beta_{it}^k \leq \frac{\sum_{f \in \mathcal{F}} \Delta_{ift}^k}{\phi_i^k}, \quad \forall i \in \mathcal{N}'^k, k \in \mathcal{K}, t \in \mathcal{T}. \quad (\text{E.9})$$

$$\beta_{ijt}^k \leq \frac{\sum_{f \in \mathcal{F}} \Delta_{ijft}^k}{\phi_{ij}^k}, \quad \forall (i, j) \in \mathcal{A}'^k, k \in \mathcal{K}, t \in \mathcal{T}. \quad (\text{E.9.arc})$$

$$\Delta_{ift}^k = \frac{\sum_{\tau=1}^t \Theta_{ift}^k}{p_{if}^k}, \quad \forall i \in \mathcal{N}'^k, k \in \mathcal{K}, f \in \mathcal{F}, t \in \mathcal{T}. \quad (\text{E.10})$$

$$\Delta_{ijft}^k = \frac{\sum_{\tau=1}^t \Theta_{ijf\tau}^k}{p_{ijf}^k}, \quad \forall (i, j) \in \mathcal{A}'^k, k \in \mathcal{K}, f \in \mathcal{F}, t \in \mathcal{T}. \quad (\text{E.10.arc})$$

$$\Theta_{ift}^k = \sum_{w \in \mathcal{W}} \sum_{\pi \in \Pi} \eta_{\pi ft} E_{\pi f} Z_{\pi wt} \alpha_{iwt}^k, \quad \forall i \in \mathcal{N}'^k, k \in \mathcal{K}, f \in \mathcal{F}, t \in \mathcal{T}. \quad (\text{E.11})$$

$$\Theta_{ijft}^k = \sum_{w \in \mathcal{W}} \sum_{\pi \in \Pi} \eta_{\pi ft} E_{\pi f} Z_{\pi wt} \alpha_{ijwt}^k, \quad \forall (i, j) \in \mathcal{A}'^k, k \in \mathcal{K}, f \in \mathcal{F}, t \in \mathcal{T}. \quad (\text{E.11.arc})$$

$$\sum_{f \in \mathcal{F}} \eta_{\pi ft} \leq 1, \quad \forall \pi \in \Pi, t \in \mathcal{T}. \quad (\text{E.12})$$

$$\sum_{w \in \mathcal{W}} Z_{\pi wt} = 1, \quad \forall \pi \in \Pi, t \in \mathcal{T}. \quad (\text{E.13})$$

$$\sum_{\pi \in \Pi} Z_{\pi wt} \geq 2, \quad \forall w \in \mathcal{W}, t \in \mathcal{T}. \quad (\text{E.14})$$

$$\sum_{i \in \mathcal{N}'^k} \alpha_{iwt}^k + \sum_{(i,j) \in \mathcal{A}'^k} \alpha_{ijwt}^k \leq \Omega, \quad \forall w \in \mathcal{W}, t \in \mathcal{T}. \quad (\text{E.15})$$

E.4.3. Operational interdependencies

$$\sum_{i \in \mathcal{N}_{i\psi\xi}^{k\tilde{k}}} \gamma_{i\psi\xi t}^{k\tilde{k}} y_{it}^k \geq y_{it}^{\tilde{k}}, \quad \forall i \in \mathcal{N}^{\tilde{k}}, \tilde{k} \in \mathcal{K}, \psi \in \Psi, \xi \in \Xi, t \in \mathcal{T}. \quad (\text{E.16})$$

$$y_{it}^k b_{ilt}^k \geq b_{ilt}^k + x_{ilt}^{-k}, \quad \forall i \in \mathcal{N}_D^k, l \in \mathcal{L}^k, k \in \mathcal{K}, t \in \mathcal{T}. \quad (\text{E.17})$$

E.4.4. Restoration interdependencies

E.4.4.1. Traditional precedence

$$\sum_{\tau=1}^t \beta_{i\tau}^k \geq \frac{1}{\Omega} \sum_{w \in \mathcal{W}} \alpha_{iwt}^{\tilde{k}}, \quad \forall (i, \tilde{i}) \in NTP, t \in \mathcal{T}. \quad (\text{E.18.n2n})$$

$$\sum_{\tau=1}^t \beta_{i\tau}^k \geq \frac{1}{\Omega} \sum_{w \in \mathcal{W}} \alpha_{ijwt}^{\tilde{k}}, \quad \forall (i, (\tilde{i}, \tilde{j})) \in NTP, t \in \mathcal{T}. \quad (\text{E.18.n2a})$$

$$\sum_{\tau=1}^t \beta_{ij\tau}^k \geq \frac{1}{\Omega} \sum_{w \in \mathcal{W}} \alpha_{iwt}^{\tilde{k}}, \quad \forall ((i, j), \tilde{i}) \in ATP, t \in \mathcal{T}. \quad (\text{E.18.a2n})$$

$$\sum_{\tau=1}^t \beta_{ij\tau}^k \geq \frac{1}{\Omega} \sum_{w \in \mathcal{W}} \alpha_{ijwt}^{\tilde{k}}, \quad \forall ((i, j), (\tilde{i}, \tilde{j})) \in ATP, t \in \mathcal{T}. \quad (\text{E.18.a2a})$$

$$\Omega y_{it}^k \geq \alpha_{iwt}^{\tilde{k}}, \quad \forall (i, \tilde{i}) \in NTP, w \in \mathcal{W}, t \in \mathcal{T}. \quad (\text{E.19.n2n})$$

$$\Omega y_{it}^k \geq \alpha_{ijwt}^{\tilde{k}}, \quad \forall (i, (\tilde{i}, \tilde{j})) \in NTP, w \in \mathcal{W}, t \in \mathcal{T}. \quad (\text{E.19.n2a})$$

E.4.4.2. Effectiveness precedence

$$\Delta_{ift}^k = \sum_{\tau=1}^t \left(\frac{\theta_{if\tau}^k}{p_{if}^k} + \frac{\theta_{ief\tau}^k}{e_{if}^k} \right), \quad \forall i \in \mathcal{N}^k, (\tilde{i}, i) \in NEP, ((\tilde{i}, \tilde{j}), i) \in AEP, k \in \mathcal{K}, f \in \mathcal{F}, t \in \mathcal{T}. \quad (\text{E.10*})$$

$$\Delta_{ijft}^k = \sum_{\tau=1}^t \left(\frac{\theta_{ijf\tau}^k}{p_{ijf}^k} + \frac{\theta_{ijef\tau}^k}{e_{ijf}^k} \right), \quad \forall (i, j) \in \mathcal{A}^k, (\tilde{i}, (i, j)) \in NEP, ((\tilde{i}, \tilde{j}), (i, j)) \in AEP, k \in \mathcal{K}, f \in \mathcal{F}, t \in \mathcal{T}. \quad (\text{E.10*.arc})$$

$$\Theta_{eft}^k = \sum_{w \in \mathcal{W}} \sum_{\pi \in \Pi} \eta_{\pi ft} E_{\pi f} Z_{\pi wt} \alpha_{i_e wt}^k, \quad \forall (\tilde{i}, i) \in NEP, ((\tilde{i}, \tilde{j}), i) \in AEP, f \in \mathcal{F}, t \in \mathcal{T}. \quad (\text{E.20})$$

$$\Theta_{ij_e ft}^k = \sum_{w \in \mathcal{W}} \sum_{\pi \in \Pi} \eta_{\pi ft} E_{\pi f} Z_{\pi wt} \alpha_{ij_e wt}^k, \quad \forall (\tilde{i}, (i, j)) \in NEP, ((\tilde{i}, \tilde{j}), (i, j)) \in AEP, f \in \mathcal{F}, t \in \mathcal{T}. \quad (\text{E.20.arc})$$

$$\sum_{i \in \mathcal{N}'^k} \alpha_{iwt}^k + \sum_{(i,j) \in \mathcal{A}'^k} \alpha_{ijwt}^k + \sum_{\left(\begin{array}{l} (i,\tilde{i}) \in NEP, \\ ((\tilde{i},j),i) \in AEP \end{array} \right)} \alpha_{i_e wt}^k +$$

$$\sum_{\left(\begin{array}{l} (\tilde{i},(i,j)) \in NEP, \\ ((\tilde{i},j),i) \in AEP \end{array} \right)} \alpha_{i_e wt}^k \leq \Omega, \quad \forall w \in \mathcal{W}, t \in \mathcal{T}. \quad (\text{E.14}^*)$$

$$\sum_{\tau=1}^t \beta_{i\tau}^k \leq \sum_{\tau=1}^t \sum_{w \in \mathcal{W}} \alpha_{i_e w\tau}^{\tilde{k}} + \sum_{\tau=1}^{\min\left[T, t - \frac{\sum_{f \in \mathcal{F}} p_{if}^k}{\Omega \phi_i^k}\right]} \sum_{w \in \mathcal{W}} \alpha_{i w\tau}^k, \quad \forall (i, \tilde{i}) \in NEP, f \in \mathcal{F}, t \in \mathcal{T}. \quad (\text{E.21.n2n})$$

$$\sum_{\tau=1}^t \beta_{i\tau}^k \leq \sum_{\tau=1}^t \sum_{w \in \mathcal{W}} \alpha_{i_e w\tau}^{\tilde{k}} + \sum_{\tau=1}^{\min\left[T, t - \frac{\sum_{f \in \mathcal{F}} p_{if}^k}{\Omega \phi_i^k}\right]} \sum_{w \in \mathcal{W}} \alpha_{i w\tau}^k, \quad \forall (i, (\tilde{i}, \tilde{j})) \in NEP, f \in \mathcal{F}, t \in \mathcal{T}. \quad (\text{E.21.n2a})$$

$$\sum_{\tau=1}^t \beta_{ij\tau}^k \leq \sum_{\tau=1}^t \sum_{w \in \mathcal{W}} \alpha_{i_e w\tau}^{\tilde{k}} + \sum_{\tau=1}^{\min\left[T, t - \frac{\sum_{f \in \mathcal{F}} p_{ijf}^k}{\Omega \phi_{ij}^k}\right]} \sum_{w \in \mathcal{W}} \alpha_{ij w\tau}^k, \quad \forall ((i, j), \tilde{i}) \in AEP, t \in \mathcal{T}. \quad (\text{E.21.a2n})$$

$$\sum_{\tau=1}^t \beta_{ijw\tau}^k \leq \sum_{\tau=1}^t \sum_{w \in \mathcal{W}} \alpha_{ij_e w\tau}^{\tilde{k}} +$$

$$\sum_{\tau=1}^{\min\left[T, t - \frac{\sum_{f \in \mathcal{F}} p_{ijf}^k}{\Omega \phi_{ij}^k}\right]} \sum_{w \in \mathcal{W}^k} \alpha_{ij w\tau}^k, \quad \forall ((i, j), (\tilde{i}, \tilde{j})) \in AEP, f \in \mathcal{F}, t \in \mathcal{T}. \quad (\text{E.21.a2a})$$

$$\Omega y_{it}^k \geq \alpha_{iwt}^{\tilde{k}}, \quad \forall (i, \tilde{i}) \in NEP, w \in \mathcal{W}, t \in \mathcal{T}. \quad (\text{E.22.n2n})$$

$$\Omega y_{it}^k \geq \alpha_{ijw\tau}^{\tilde{k}}, \quad \forall (i, (\tilde{i}, \tilde{j})) \in NEP, w \in \mathcal{W}, t \in \mathcal{T}. \quad (\text{E.22.n2a})$$

E.4.4.3. Options precedence

$$\sum_{\tau=1}^t \sum_{(i,\tilde{i}) \in NOP} \beta_{i\tau}^k \geq \frac{1}{\Omega} \sum_{w \in \mathcal{W}} \alpha_{iwt}^{\tilde{k}}, \quad \forall (i, \tilde{i}) \in NOP, t \in \mathcal{T}. \quad (\text{E.23.n2n})$$

$$\sum_{\tau=1}^t \sum_{(i,(\tilde{i},\tilde{j})) \in NOP} \beta_{i\tau}^k \geq \frac{1}{\Omega} \sum_{w \in \mathcal{W}} \alpha_{ijw\tau}^{\tilde{k}}, \quad \forall (i, (\tilde{i}, \tilde{j})) \in NOP, t \in \mathcal{T}. \quad (\text{E.23.n2a})$$

$$\sum_{\tau=1}^t \sum_{((i,j),\tilde{i}) \in AOP} \beta_{ij\tau}^k \geq \frac{1}{\Omega} \sum_{w \in \mathcal{W}} \alpha_{iwt}^{\tilde{k}}, \quad \forall ((i, j), \tilde{i}) \in AOP, t \in \mathcal{T}. \quad (\text{E.23.a2n})$$

$$\sum_{\tau=1}^t \sum_{((i,j),(\tilde{i},\tilde{j})) \in AOP} \beta_{ij\tau}^k \geq \frac{1}{\Omega} \sum_{w \in \mathcal{W}} \alpha_{ijw\tau}^{\bar{k}}, \quad \forall ((i,j),(\tilde{i},\tilde{j})) \in AOP, t \in \mathcal{T}. \quad (\text{E.23.a2a})$$

$$\Omega y_{it}^k \geq \alpha_{iwt}^{\bar{k}}, \quad \forall (i,\tilde{i}) \in NOP, w \in \mathcal{W}, t \in \mathcal{T}. \quad (\text{E.24.n2n})$$

$$\Omega y_{it}^k \geq \alpha_{ijw\tau}^{\bar{k}}, \quad \forall (i,(\tilde{i},\tilde{j})) \in NOP, w \in \mathcal{W}, t \in \mathcal{T}. \quad (\text{E.24.n2a})$$

E.4.4.4. Time sensitive options

$$y_{it}^k + \sum_{\tau=\theta_{ii}^{k\bar{k}}}^t (\sum_{w \in \mathcal{W}} \alpha_{iwt}^{\bar{k}} + \beta_{i\tau}^{\bar{k}}) \geq 1, \quad t = \theta_{ii}^{k\bar{k}}, \dots, T, \quad \forall (i,\tilde{i}) \in NTS. \quad (\text{E.25.n2n})$$

$$y_{it}^k + \sum_{\tau=\theta_{ij}^{k\bar{k}}}^t (\sum_{w \in \mathcal{W}} \alpha_{ijw\tau}^{\bar{k}} + \beta_{ij\tau}^{\bar{k}}) \geq 1, \quad t = \theta_{ij}^{k\bar{k}}, \dots, T, \quad \forall (i,(\tilde{i},\tilde{j})) \in NTS. \quad (\text{E.25.n2a})$$

$$y_{ijt}^k + \sum_{\tau=\theta_{ji}^{k\bar{k}}}^t (\sum_{w \in \mathcal{W}} \alpha_{iwt}^{\bar{k}} + \beta_{i\tau}^{\bar{k}}) \geq 1, \quad t = \theta_{ji}^{k\bar{k}}, \dots, T, \quad \forall ((i,j),\tilde{i}) \in ATS. \quad (\text{E.25.a2n})$$

$$y_{ijt}^k + \sum_{\tau=\theta_{ij}^{k\bar{k}}}^t (\sum_{w \in \mathcal{W}} \alpha_{ijw\tau}^{\bar{k}} + \beta_{ij\tau}^{\bar{k}}) \geq 1, \quad t = \theta_{ij}^{k\bar{k}}, \dots, T, \quad \forall ((i,j),(\tilde{i},\tilde{j})) \in ATS. \quad (\text{E.25.a2a})$$

$$\sum_{w \in \mathcal{W}} \alpha_{iwt}^{\bar{k}} = 0, \quad t = 1, \dots, \theta_{ii}^{k\bar{k}} - 1, \quad \forall (i,\tilde{i}) \in NTS. \quad (\text{E.26.n2n})$$

$$\sum_{w \in \mathcal{W}} \alpha_{iwt}^{\bar{k}} = 0, \quad t = 1, \dots, \theta_{ij}^{k\bar{k}} - 1, \quad \forall (i,(\tilde{i},\tilde{j})) \in NTS. \quad (\text{E.26.n2a})$$

$$\sum_{w \in \mathcal{W}} \alpha_{ijw\tau}^{\bar{k}} = 0, \quad t = 1, \dots, \theta_{ji}^{k\bar{k}} - 1, \quad \forall ((i,j),\tilde{i}) \in ATS. \quad (\text{E.26.a2n})$$

$$\sum_{w \in \mathcal{W}} \alpha_{ijw\tau}^{\bar{k}} = 0, \quad t = 1, \dots, \theta_{ij}^{k\bar{k}} - 1, \quad \forall ((i,j),(\tilde{i},\tilde{j})) \in ATS. \quad (\text{E.26.a2a})$$

E.4.4.5. Geospatial repair

$$\frac{1}{\Omega} \sum_{w \in \mathcal{W}} g_{is}^k (\alpha_{iwt}^k + \alpha_{i_e w t}^k) \leq z_{st}, \quad \forall i \in \mathcal{N}'^k, s \in \mathcal{S}, k \in \mathcal{K}, t \in \mathcal{T}. \quad (\text{E.27})$$

$$\frac{1}{\Omega} \sum_{w \in \mathcal{W}} g_{ijs}^k (\alpha_{ijw\tau}^k + \alpha_{ij_e w \tau}^k) \leq z_{st}, \quad \forall (i,j) \in \mathcal{A}'^k, s \in \mathcal{S}, k \in \mathcal{K}, t \in \mathcal{T}. \quad (\text{E.27.arc})$$

C.4.5. Side constraints

$$x_{ijlt}^k \geq 0, \forall (i,j) \in \mathcal{A}^k, l \in \mathcal{L}^k, k \in \mathcal{K}, t \in \mathcal{T}. \quad (\text{E.28})$$

$$x_{ilt}^{-,k} \geq 0, \forall i \in \mathcal{N}^k, l \in \mathcal{L}^k, k \in \mathcal{K}, t \in \mathcal{T}. \quad (\text{E.29})$$

$$x_{ilt}^{+,k} \geq 0, \forall i \in \mathcal{N}^k, l \in \mathcal{L}^k, k \in \mathcal{K}, t \in \mathcal{T}. \quad (\text{E.30})$$

$$y_{it}^k \in \{0,1\}, \forall i \in \mathcal{N}^k, k \in \mathcal{K}, t \in \mathcal{T}. \quad (\text{E.31})$$

$$y_{ijt}^k \in \{0,1\}, \forall (i,j) \in \mathcal{A}^k, k \in \mathcal{K}, t \in \mathcal{T}. \quad (\text{E.31.arc})$$

$$z_{st} \in \{0,1\}, \forall s \in \mathcal{S}, t \in \mathcal{T}. \quad (\text{E.32})$$

$$Z_{\pi wt} \in \{0,1\}, \forall \pi \in \Pi, w \in \mathcal{W}, t \in \mathcal{T}. \quad (\text{E.33})$$

$$0 \leq \alpha_{iwt}^k \leq \Omega, \forall i \in \mathcal{N}'^k, w \in \mathcal{W}, k \in \mathcal{K}, t \in \mathcal{T}. \quad (\text{E.34})$$

$$0 \leq \alpha_{ijwt}^k \leq \Omega, \forall (i,j) \in \mathcal{A}'^k, w \in \mathcal{W}, k \in \mathcal{K}, t \in \mathcal{T}. \quad (\text{E.34.arc})$$

$$0 \leq \alpha_{i_{e}wt}^k \leq \Omega, \forall (i, \tilde{i}), (i, (\tilde{i}, \tilde{j})) \in NEP, w \in \mathcal{W}, k \in \mathcal{K}, t \in \mathcal{T}. \quad (\text{E.35})$$

$$0 \leq \alpha_{ij_{e}wt}^k \leq \Omega, \forall ((i,j), \tilde{i}), ((i,j), (\tilde{i}, \tilde{j})) \in AEP, w \in \mathcal{W}, k \in \mathcal{K}, t \in \mathcal{T}. \quad (\text{E.35.arc})$$

$$\beta_{it}^k \in \{0,1\}, \forall i \in \mathcal{N}'^k, k \in \mathcal{K}, t \in \mathcal{T}. \quad (\text{E.36})$$

$$\beta_{ijt}^k \in \{0,1\}, \forall (i,j) \in \mathcal{A}'^k, k \in \mathcal{K}, t \in \mathcal{T}. \quad (\text{E.36.arc})$$

$$0 \leq \Delta_{ift}^k \leq 1, \forall i \in \mathcal{N}'^k, k \in \mathcal{K}, t \in \mathcal{T}. \quad (\text{E.37})$$

$$0 \leq \Delta_{ijft}^k \leq 1, \forall (i,j) \in \mathcal{A}'^k, k \in \mathcal{K}, t \in \mathcal{T}. \quad (\text{E.37.arc})$$

$$0 \leq \eta_{\pi ft} \leq 1, \forall \pi \in \Pi, f \in \mathcal{F}, t \in \mathcal{T}. \quad (\text{E.38})$$

$$0 \leq \Theta_{ift}^k \leq p_{if}^k, \forall i \in \mathcal{N}'^k, k \in \mathcal{K}, f \in \mathcal{F}, t \in \mathcal{T}. \quad (\text{E.39})$$

$$0 \leq \Theta_{ijft}^k \leq p_{ijf}^k, \forall (i,j) \in \mathcal{A}'^k, k \in \mathcal{K}, f \in \mathcal{F}, t \in \mathcal{T}. \quad (\text{E.39.arc})$$

$$0 \leq \Theta_{i_{e}ft}^k \leq e_{if}^k, \forall i \in \mathcal{N}'^k, k \in \mathcal{K}, f \in \mathcal{F}, t \in \mathcal{T}. \quad (\text{E.40})$$

$$0 \leq \Theta_{ijft}^k \leq e_{ijf}^k, \forall (i, j) \in \mathcal{A}^k, k \in \mathcal{K}, f \in \mathcal{F}, t \in \mathcal{T}. \quad (\text{E.40.arc})$$

$$0 \leq \sum_{t \in \mathcal{T}} \Delta_{ift}^k \leq 1, \forall i \in \mathcal{N}^k, k \in \mathcal{K}. \quad (\text{E.41})$$

$$0 \leq \sum_{t \in \mathcal{T}} \Delta_{ijft}^k \leq 1, \forall (i, j) \in \mathcal{A}^k, k \in \mathcal{K}. \quad (\text{E.41.arc})$$

$$0 \leq \sum_{t \in \mathcal{T}} \Theta_{ift}^k \leq p_{if}^k, \forall i \in \mathcal{N}^k, k \in \mathcal{K}, f \in \mathcal{F}. \quad (\text{E.42})$$

$$0 \leq \sum_{t \in \mathcal{T}} \Theta_{ijft}^k \leq p_{ijf}^k, \forall (i, j) \in \mathcal{A}^k, k \in \mathcal{K}, f \in \mathcal{F}. \quad (\text{E.42.arc})$$

$$0 \leq \sum_{t \in \mathcal{T}} \Theta_{ieft}^k \leq e_{if}^k, \forall i \in \mathcal{N}^k, k \in \mathcal{K}, f \in \mathcal{F}. \quad (\text{E.43})$$

$$0 \leq \sum_{t \in \mathcal{T}} \Theta_{ijeft}^k \leq e_{ijf}^k, \forall (i, j) \in \mathcal{A}^k, k \in \mathcal{K}, f \in \mathcal{F}. \quad (\text{E.43.arc})$$

E.4.6. Equation descriptions

Table E1 summarizes and categorizes the equations. The equations are categorized as either objective functions, flow constraints, recovery constraints, scheduling constraints, interdependency constraints, or side constraints. Table E1 seeks to strike a balance between completeness and brevity by combining like equations.

Table E.1. Summary of objective function and constraints for tmBIIRM

Ref	Category	Description
E.1	Objective func.	Least cost recovery strategies. The five terms are 1) site preparation costs, 2) assignment costs, 3) arc repair costs, 4) node repair costs, and 5) flow costs.
E.2	Objective func.	Weighted operability of nodes and arcs, which represents a surrogate for mission impact or disruptive effect.
E.3	Objective func.	Weighted and combined multiobjective function using E.1 and E.2.
E.4 to E.7	Flow constraints	Standard flow balance (E.4), restriction of flow based on operable starting node (E.5), ending node (E.6), and arc (E.7).
E.8 to E.10	Recovery constraints	Ensures that a restored asset becomes operable (E.8), assets are repaired once work is completed (E.9), and work completed is defined as work being assigned for required amount (E.10).
E.11 to E.15	Scheduling constraints	Effective work time assigned is based on worker experience level (E.11). Ensures workers spread their time across the skills they have (E.12), can only be assigned to one work crew in a time period (E.13), every work crew must have at least two people (E.14), and that every work crew isn't assigned more hours than in a time period.
E.16 to E.17	Interdependency constraints	Child node operability depends on parent node's operability (E.16) and nodes are operable if demand is met (E.17).
E.18 to E.19	Interdependency constraints	Traditional precedence completion order (E.18), assignment requires operable parent node (E.19).
E.20 to E.22	Interdependency constraints	Effective work time assigned is based on worker experience level (E.20). Effectiveness precedence completion order (E.21) and traditional assignment requirement (E.22).
E.23 to E.24	Interdependency constraints	Options precedence completion order (E.23) and traditional assignment requirement (E.24).
E.25 to E.26	Interdependency constraints	Time-sensitive options completion requirement (E.25) and restriction of assignment until deadline (E.26).
E.27	Interdependency constraints	Geospatial repair of nodes and arcs, which can enable cost savings for co-located work.
E.28 to E.43	Side constraints	Variable definitions and bounds.

Bibliography

- “Trilemma.” (2021). *Wikipedia*.
- “Trilemma.” (2021). *Merriam-Webster Online Dictionary*, <<https://www.merriam-webster.com/dictionary/trilemma>> (Jun. 3, 2021).
- Ahmed, S., Islam, H., Hoque, I., and Hossain, M. (2020). “Reality check against skilled worker parameters and parameters failure effect on the construction industry for Bangladesh.” *International Journal of Construction Management*, Taylor & Francis, 20(5), 480–489.
- Ahuja, R. K., Magnanti, T. L., and Orlin, J. B. (1993). “Multicommodity Flows.” *Network Flows: Theory, Algorithms, and Application*, Prentice-Hall Inc., 649–694.
- Akhtar, Z. (2021). “How to Cut your Cell Phone Bill by 80%.” *US Mobile*, <<https://www.usmobile.com/blog/cut-cell-phone-bill/>> (Mar. 5, 2021).
- Aksu, D. T., and Ozdamar, L. (2014). “A mathematical model for post-disaster road restoration: Enabling accessibility and evacuation.” *Transportation Research Part E*, 61, 56–67.
- Almoghathawi, Y., Barker, K., and Albert, L. A. (2019). “Resilience-driven restoration model for interdependent infrastructure networks.” *Reliability Engineering and System Safety*, Elsevier Ltd, 185, 12–23.
- Almoghathawi, Y., Barker, K., and Ramirez-marquez, J. E. (2017). “Resilience-Based Measures for Importance Ranking of Interdependent Infrastructure Networks Components Across Uncertain Disruption Scenarios.” *Proceedings of the 12th International Conference on Structural Safety and Reliability*, (August), 6–10.
- Alwasel, A., Abdel-Rahman, E. M., Haas, C. T., and Lee, S. (2017). “Experience, Productivity, and Musculoskeletal Injury among Masonry Workers.” *Journal of Construction Engineering and Management*, American Society of Civil Engineers, 143(6), 05017003.
- American Society of Civil Engineers. (2019). *Future World Vision: Infrastructure Reimagined*. ASCE.
- Ang, C. C. (2006). “Optimized recovery of damaged electrical power grids.” Naval Post Graduate School.
- Arora, J. S. (2017). “Multi-objective Optimum Design Concepts and Methods.” *Introduction to Optimum Design*, Elsevier Inc., 771–794.

- Atkinson, R. (1999). "Project management: Cost, time and quality, two best guesses and a phenomenon, its time to accept other success criteria." *International Journal of Project Management*, Elsevier BV, 17(6), 337–342.
- Attoh-Okine, N. O. (2016). *Resilience Engineering: Models and Analysis*. Cambridge University Press, New York.
- Averbakh, I., and Pereira, J. (2012). "The flowtime network construction problem." *IIE Transactions*, 44(8), 681–694.
- Barker, K., Lambert, J. H., Zobel, C. W., Tapia, A. H., Ramirez-Marquez, J. E., Albert, L., Nicholson, C. D., and Caragea, C. (2017). "Defining resilience analytics for interdependent cyber-physical-social networks." *Sustainable and Resilient Infrastructure*, Taylor & Francis, 2(2), 59–67.
- Barr, S., Alderson, D., Ives, M. C., and Robson, C. (2016). "Database, Simulation Modelling and Visualisation for National Infrastructure Assessment." *The Future of National Infrastructure: A System-of-Systems Approach*, J. W. Hall, M. Tran, A. J. Hickford, and R. J. Nicholls, eds., Cambridge University Press, Cornwall.
- Baxter, M., Eldingy, T., Ernst, A., Kalinowski, T., and Savelsbergh, M. (2014). "Incremental network design with shortest paths." *European Journal of Operational Research*, 238(3), 675–684.
- Benmokhtar, A., Benouar, D., and Rahmoune, A. (2020). "Modeling the propagation of the effects of a disturbance in a critical infrastructure system to increase its resilience." *Urbanism. Architectura. Constructii.*, 11(2), 157–178.
- Bianconi, G. (2018). *Multilayer Networks: Structure and Function*. Oxford University Press.
- Bobbio, A., Bonanni, G., Ciancamerla, E., Clemente, R., Iacomini, A., Minichino, M., Scarlatti, A., Terruggia, D., and Zendri, E. (2010). "Unavailability of critical SCADA communication links interconnecting a power grid and a Telco network." *Reliability Engineering and System Safety*, 95, 1345–1357.
- Boccaletti, S., Bianconi, G., Criado, R., del Genio, C. I., Gómez-Gardeñes, J., Romance, M., Sendiña-Nadal, I., Wang, Z., and Zanin, M. (2014). *The structure and dynamics of multilayer networks*. *Physics Reports*.
- Buldyrev, S. V., Parshani, R., Paul, G., Stanley, H. E., and Havlin, S. (2010). "Catastrophic cascade of failures in interdependent networks." *Nature*, Nature Publishing Group, 464(7291), 1025–1028.

- Cavallo, A., and Ireland, V. (2014). “Preparing for complex interdependent risks: A System of Systems approach to building disaster resilience.” *International Journal of Disaster Risk Reduction*, Elsevier, 9, 181–193.
- Cavdaroglu, B., Hammel, E., Mitchell, J. E., Sharkey, T. C., and Wallace, W. A. (2013). “Integrating restoration and scheduling decisions for disrupted interdependent infrastructure systems.” *Annals of Operations Research*, 203(1), 279–294.
- Chai, W. K., Kyritsis, V., Katsaros, K. V., and Pavlou, G. (2016). “Resilience of interdependent communication and power distribution networks against cascading failures.” *2016 IFIP Networking Conference (IFIP Networking) and Workshops, IFIP Networking 2016*, 37–45.
- Chee, C. H., and Neo, H. (2018). “5 big challenges facing big cities of the future.” *World Economic Forum*, Singapore.
- Comerio, M. C. (2014). “Disaster recovery and community renewal: Housing approaches.” *Cityscape*, 16(2), 51–68.
- Cutter, S. L. (2016). “The landscape of disaster resilience indicators in the USA.” *Natural Hazards*, Springer Netherlands, 80(2), 741–758.
- Cybersecurity and Infrastructure Security Agency (CISA). (n.d.). “Protected Critical Infrastructure Information (PCII) Program.” *cisa.gov*, <<https://www.cisa.gov/pcii-program>> (Mar. 26, 2021).
- Cybersecurity and Infrastructure Security Agency (CISA). (2005). “Protected Critical Infrastructure Information (PCII) Program Fact Sheet.” *Fact Sheet*, <<https://www.cisa.gov/sites/default/files/publications/pcii-program-factsheet-final-19jul05-508.pdf>> (Mar. 26, 2021).
- Department of Defense (DoD). (2020). *UFC 3-701-01, Change 6, DoD Facilities Pricing Guide*.
- Department of Defense (DoD). (2010). *Unified Facilities Criteria (UFC) 3-740-05, Handbook: Construction Cost Estimating, with Change 2*.
- Department of Homeland Security. (2013). *NIPP 2013: Partnering for critical infrastructure security and resilience. National Infrastructure Protection Plan*.
- Department of Homeland Security. (2009). *The National Infrastructure Protection Plan (NIPP): Partnering to enhance protection and resiliency*.

- Dilley, J. (2021). “How Much Should I Be Paying for High-Speed Internet?” *HighSpeedInternet.com*, <<https://www.highspeedinternet.com/resources/how-much-should-i-be-paying-for-high-speed-internet-resource>> (Mar. 5, 2021).
- Dinardi, G. (2019). “How Much is A Business Phone Line? (Pricing + Phone Types).” *Nextiva Blog*, <<https://www.nextiva.com/blog/how-much-is-a-business-phone-line.html>> (Mar. 5, 2021).
- Eusgeld, I., and Kröger, W. (2008). “Comparative evaluation of modeling and simulation techniques for interdependent critical infrastructures.” *9th International Conference on Probabilistic Safety Assessment and Management 2008, PSAM 2008*, 1(January 2008), 484–491.
- Eusgeld, I., Nan, C., and Dietz, S. (2011). “‘System-of-systems’ approach for interdependent critical infrastructures.” *Reliability Engineering and System Safety*, Elsevier, 96(6), 679–686.
- Faturechi, R., and Miller-Hooks, E. (2014). “Measuring the Performance of Transportation Infrastructure Systems in Disasters: A Comprehensive Review.” *Journal of Infrastructure Systems*, 21(1), 04014025.
- Fletcher, S. (2001). “Electric power interruptions curtail California oil and gas production.” *Oil and Gas Journal*, (February).
- Frost, B. (2020). “Comcast Business Internet Review: 2021.” *Business.org*, <<https://www.business.org/services/internet/comcast-business-internet-review/>> (Mar. 5, 2021).
- GAMS Development Corp. (2021). “The GAMS Call and Command Line Parameters.” *GAMS Documentation*, <https://www.gams.com/latest/docs/UG_GamsCall.html#GAMSAOoptcr> (Jun. 24, 2021).
- Givetash, L. (2020). “Australian wildfires declared among the ‘worst wildlife disasters in modern history.’” *NBC News*.
- González, A. D. (2017). “Resilience optimization of systems of interdependent networks.” Rice University, Dissertation.
- González, A. D., Chapman, A., Dueñas-Osorio, L., Mesbahi, M., and D’Souza, R. M. (2017). “Efficient Infrastructure Restoration Strategies Using the Recovery Operator.” *Computer-Aided Civil and Infrastructure Engineering*, 32(12), 991–1006.

- González, A. D., Dueñas-Osorio, L., Sánchez-Silva, M., and Medaglia, A. L. (2016). “The Interdependent Network Design Problem for Optimal Infrastructure System Restoration.” *Computer-Aided Civil and Infrastructure Engineering*, 31(5), 334–350.
- Griot, C. (2010). “Modelling and simulation for critical infrastructure interdependency assessment: a meta-review for model characterisation.” *International Journal of Critical Infrastructures*, 6(4), 363–379.
- Guha, S., Moss, A., Naor, J. (Seffi), and Schieber, B. (1999). “Efficient recovery from power outage (extended abstract).” *Proceedings of the thirty-first annual ACM symposium on Theory of computing - STOC '99*, ACM Press, New York, New York, USA, 574–582.
- Haimes, Y. Y., Lasdon, L. S., and Wismer, D. A. (1971). “On a bicriterion formulation of the problems of integrated identification and system optimization.” *IEEE Transactions on Systems, Man and Cybernetics*, SMC-1(3), 296–297.
- Haimes, Y. Y., Santos, J., Crowther, K., Henry, M., Lian, C., and Yan, Z. (2007). “Risk Analysis in Interdependent Infrastructures.” *Critical Infrastructure Protection*, 253, 297–310.
- Hall, J. W., Nicholls, R. J., Hickford, A. J., and Tran, M. (2016). “Introducing National Infrastructure Assessment.” *The Future of National Infrastructure: A System-of-Systems Approach*, J. W. Hall, M. Tran, A. J. Hickford, and R. J. Nicholls, eds., Cambridge University Press, Cornwall.
- Hanley, T., Daecher, A., Cotteleer, M., and Sniderman, B. (2019). “The Industry 4.0 paradox.” *Deloitte Review*, (24).
- Henry, D., and Ramirez-Marquez, J. E. (2012). “Generic metrics and quantitative approaches for system resilience as a function of time.” *Reliability Engineering and System Safety*, Elsevier, 99, 114–122.
- Holden, R., Val, D. V., Burkhard, R., and Nodwell, S. (2013). “A network flow model for interdependent infrastructures at the local scale.” *Safety Science*, Elsevier Ltd, 53, 51–60.
- homeadvisor.com. (2021). “2021 Plumbing Cost Estimates: Leak, Pipe Repair Prices.” <<https://www.homeadvisor.com/cost/plumbing/>> (Mar. 2, 2021).
- homeadvisor.com. (2021). “2021 Electrician Costs & Average Hourly Rates.” <<https://www.homeadvisor.com/cost/electrical/hire-an-electrician/>> (Mar. 2, 2021).

- homeadvisor.com. (2021). “2021 Costs of Trenching | Cost to Dig a Trench Per Foot.” <<https://www.homeadvisor.com/cost/landscape/trenching/>> (Mar. 1, 2021).
- Hosseini, S., Barker, K., and Ramirez-Marquez, J. E. (2016). “A review of definitions and measures of system resilience.” *Reliability Engineering and System Safety*, 145, 47–61.
- howmuch.net. (2020). “How much does it cost to clear a land and prepare a building site?” <<https://howmuch.net/costs/land-clearing-building-site-preparation>> (Mar. 1, 2021).
- IEEE Computer Society. (2010). “IEEE Standard for Modeling and Simulation (M&S) High Level Architecture (HLA) - Federate Interface Specification (IEEE 1516.1).”
- Iloglu, S., and Albert, L. A. (2018). “An integrated network design and scheduling problem for network recovery and emergency response.” *Operations Research Perspectives*, Elsevier Ltd, 5, 218–231.
- Iloglu, S., and Albert, L. A. (2020). “A maximal multiple coverage and network restoration problem for disaster recovery.” *Operations Research Perspectives*, Elsevier Ltd, 7, 100132.
- International Organization for Standardization (ISO). (2014). “ISO 55000: Asset Management - Overview, Principles, and Terminology.”
- Jenkins, K., Surminski, S., Hall, J., and Crick, F. (2017). “Assessing surface water flood risk and management strategies under future climate change: Insights from an Agent-Based Model.” *Science of the Total Environment*, Elsevier B.V., 595, 159–168.
- Johari, S., and Jha, K. N. (2020). “Interrelationship among Belief, Intention, Attitude, Behavior, and Performance of Construction Workers.” *Journal of Management in Engineering*, American Society of Civil Engineers (ASCE), 36(6), 04020081.
- Kalinowski, T., Matsypura, D., and Savelsbergh, M. W. P. (2018). *Incremental Network Design with Maximum Flows*.
- Kammouh, O., Nogal, M., Binnekamp, R., and Wolfert, A. R. M. R. (2021). “Multi-system intervention optimization for interdependent infrastructure.” *Automation in Construction*, Elsevier, 127, 103698.
- Karakoc, D. B., Almoghathawi, Y., Barker, K., González, A. D., and Mohebbi, S. (2019). “Community resilience-driven restoration model for interdependent infrastructure networks.” *International Journal of Disaster Risk Reduction*, Elsevier Ltd, 38(February), 101228.

- Karakoc, D. B., Barker, K., Zobel, C. W., and Almoghathawi, Y. (2020). "Social vulnerability and equity perspectives on interdependent infrastructure network component importance." *Sustainable Cities and Society*, Elsevier, 57(November 2019), 102072.
- Kennedy, K. T. (2003). "An Analysis of Multiple Layered Networks." Air Force Institute of Technology.
- Khanh, H. D., Kim, S.-Y., Khoa, N. Van, and Tu, N. T. (2021). "The relationship between workers' experience and productivity: a case study of brick masonry construction." *International Journal of Construction Management*, Taylor & Francis.
- kompareit.com. (2021). "Site Preparation & Land Clearing ." <<https://www.kompareit.com/homeandgarden/developers-engineers-land-prep.html>> (Mar. 1, 2021).
- Kong, J., Simonovic, S. P., and Zhang, C. (2019). "Resilience Assessment of Interdependent Infrastructure Systems: A Case Study Based on Different Response Strategies." *Sustainability (Switzerland)*, 11(23).
- Lee, E. E., Mitchell, J. E., and Wallace, W. A. (2007). "Restoration of services in interdependent infrastructure systems: A network flows approach." *IEEE Transactions on Systems, Man and Cybernetics Part C: Applications and Reviews*, 37(6), 1303–1317.
- Legal Information Institute. (2021). "10 U.S. Code § 101 - Definitions." <<https://www.law.cornell.edu/uscode/text/10/101>> (Jul. 5, 2021).
- Lewe, J. H., Hivin, L. F., and Mavris, D. N. (2014). "A multi-paradigm approach to system dynamics modeling of intercity transportation." *Transportation Research Part E: Logistics and Transportation Review*, Elsevier Ltd, 71, 188–202.
- Lewis, T. G. (2009). *Network Science: Theory and Practice*. John Wiley & Sons, Inc.
- Liberda, M., Ruwanpura, J., and Jergeas, G. (2003). "Construction Productivity Improvement: A Study of Human, Management and External Issues." *Construction Research Congress, Winds of Change: Integration and Innovation in Construction, Proceedings of the Congress*, American Society of Civil Engineers, 1–8.
- Little, R. G., Loggins, R. A., Mitchell, J. E., Ni, N., Sharkey, T. C., and Wallace, W. A. (2020). "CLARC: An Artificial Community for Modeling the Effects of Extreme Hazard Events on Interdependent Civil and Social Infrastructure Systems." *Journal of Infrastructure Systems*, American Society of Civil Engineers (ASCE), 26(1), 04019041.

- Loggins, R., Taylor, J., Brehm, S., and Wallace, W. A. (2013). *CLARC County*.
- Loggins, R. A., and Wallace, W. A. (2015). "Rapid Assessment of Hurricane Damage and Disruption to Interdependent Civil Infrastructure Systems." *Journal of Infrastructure Systems*, American Society of Civil Engineers (ASCE), 21(4).
- Loggins, R., Little, R. G., Mitchell, J., Sharkey, T., and Wallace, W. A. (2019). "CRISIS: Modeling the Restoration of Interdependent Civil and Social Infrastructure Systems Following an Extreme Event." *Natural Hazards Review*, American Society of Civil Engineers (ASCE), 20(3), 04019004.
- Matthews, R. B. (2005). "Nuclear Safety: Expect the unexpected." *Professional Safety*, 50(12), 20–27.
- McLaren, C., Havlak, C., and Stewart-Wilson, G. (2015). "What is the full cost of your commute?" *The Discourse*, <<https://thediscourse.ca/scarborough/full-cost-commute>> (Mar. 5, 2021).
- Merriam-Webster.com. (2021). "Inter- vs. Intra-: What is the Difference?" *Usage Notes*, <<https://www.merriam-webster.com/words-at-play/intra-and-inter-usage>> (Jun. 2, 2021).
- Minkel, J. (2008). "The 2003 northeast blackout-five years later." *Scientific America*.
- Moore, B., Jacques, D., and Schuldt, S. (2021). "Leveraging Network Interdependencies to Overcome Inaccessible Civil Infrastructure Data." *Submitted to Proceedings of the 2021 Winter Simulation Conference*, S. Kim, B. Feng, K. Smith, S. Masoud, C. Szabo, and M. Loper, eds., INFORMS.
- Moore, B., Schuldt, S., Grandhi, R., and Jacques, D. (2021). "Impact of Operational and Restoration Interdependencies on Recovery Time, Cost, and Disruptive Effect in Multilayered Infrastructure Networks." *Under review in Journal of Infrastructure Systems*.
- National Infrastructure Advisory Council (NIAC). (2018). *Surviving a Catastrophic Power Outage: How to Strengthen the Capabilities of the Nation*.
- Nurre, S. G., Cavdaroglu, B., Mitchell, J. E., Sharkey, T. C., and Wallace, W. A. (2012). "Restoring infrastructure systems: An integrated network design and scheduling (INDS) problem." *European Journal of Operational Research*, Elsevier B.V., 223(3), 794–806.
- OECD. (2021). "Working age population (indicator)." doi: 10.1787/d339918b-en.

- O'Rourke, T. D. (2007). "Critical Infrastructure, Interdependencies, and Resilience." *The Bridge*, 22–29.
- Oughton, E. J., Tran, M., Jones, C. B., and Ebrahimi, R. (2016). "Digital Communications and Information Systems." *The Future of National Infrastructure: A System-of-Systems Approach*, J. W. Hall, M. Tran, A. J. Hickford, and R. J. Nicholls, eds., Cambridge University Press, Cornwall.
- Ouyang, M. (2014). "Review on modeling and simulation of interdependent critical infrastructure systems." *Reliability Engineering and System Safety*, Elsevier, 121, 43–60.
- Pathirage, C., Amaratunga, D., and Haigh, R. (2005). "Recognising the importance of 'Tacit' skills of the construction worker in a knowledge environment." *Conference Item*, University of Salford, Manchester, UK.
- payscale.com. (2021). "Average Highway Maintenance Worker Hourly Pay." <https://www.payscale.com/research/US/Job=Highway_Maintenance_Worker/Hourly_Rate> (Mar. 2, 2021).
- payscale.com. (2021). "Average Telecommunications Line Installer / Repairer Hourly Pay." <https://www.payscale.com/research/US/Job=Telecommunications_Line_Installer_%2F_Repairer/Hourly_Rate> (Mar. 2, 2021).
- Pederson, P., Dudenhoeffer, D., Hartley, S., and Permann, M. (2006). *Critical Infrastructure Interdependency Modeling: A Survey of U.S. and International Research. Idaho National Laboratory Report*.
- Peretti, K. (2014). "Cyber Threat Intelligence: To Share or Not to Share-What Are the Real Concerns?" *Bloomberg BNA Privacy and Security Law Report*.
- Pew Research Center. (2019). "Demographics of Mobile Device Ownership and Adoption in the United States." *Pew Research Center*, <<https://www.pewresearch.org/internet/fact-sheet/mobile/>> (Mar. 25, 2021).
- Pinedo, M. L. (2016). *Scheduling: Theory, Algorithms, and Systems*. Springer International Publishing AG.
- Poulin, C., and Kane, M. (2021). "The Effect of Time-Varying Value on Infrastructure Resilience Assessments." *Under review in IEEE Access*.
- Ramirez-Marquez, J. E. (2019). "Towards engineering paradigms of social and community resilience." 2019 World Congress on Engineering Asset Management: Resilience, Reliability, and Asset Management.

- Ramirez-Meyers, K., Mann, W. N., Deetjen, T. A., Johnson, S. C., Rhodes, J. D., and Webber, M. (2021). "How different power plant types contribute to electric grid reliability, resilience, and vulnerability: a comparative analytical framework." *Progress in Energy*, IOP Publishing, 3(3), 033001.
- Rinaldi, S. M., Peerenboom, J. P., and Kelly, T. K. (2001). "Identifying, understanding, and analyzing critical infrastructure interdependencies." *IEEE Control Systems Magazine*, IEEE, 21(6), 11–25.
- Roberson, D. L., and Stafford, M. C. (2017). *The Redesigned Air Force Continuum of Learning: Rethinking Force Development for the Future*.
- Robert, B., Morabito, L., Cloutier, I., and Hémond, Y. (2013). "Interdependent critical infrastructure: from protection towards resilience." *Critical Infrastructure Symposium (TISP)*, West Point, NY, USA.
- Rojas, E. M., and Aramvareekul, P. (2003). "Labor Productivity Drivers and Opportunities in the Construction Industry." *Journal of Management in Engineering*, American Society of Civil Engineers, 19(2), 78–82.
- Rutgers, V., and Sniderman, B. (2018). "Around the Physical-Digital-Physical Loop: A Look at Current Industry 4.0 Capabilities." *Deloitte Insights: The Industry 4.0 Paradox*, A. Rao, J. Kaji, B. Hurley, R. Bhat, and A. Khan, eds., Deloitte Development LLC, 1–5.
- Satuntira, G., and Dueñas-Osorio, L. (2010). "Synthesis of modeling and simulation methods on critical infrastructure interdependencies research." *Sustainable and Resilient Critical Infrastructure Systems: Simulation, Modeling, and Intelligent Engineering*, 1–51.
- Sharkey, T. C., Cavdaroglu, B., Nguyen, H., Holman, J., Mitchell, J. E., and Wallace, W. A. (2015). "Interdependent network restoration: On the value of information-sharing." *European Journal of Operational Research*, Elsevier Ltd., 244(1), 309–321.
- Sharkey, T. C., Nurre, S. G., Nguyen, H., Chow, J. H., Mitchell, J. E., and Wallace, W. A. (2016). "Identification and classification of restoration interdependencies in the wake of hurricane sandy." *Journal of Infrastructure Systems*, 22(1).
- Sharkey, T., Ni, N., Little, R., Loggins, R., Wallace, W., and Nurre, S. (2018). "CLARC: An Artificial Community for Modeling the Effects of Extreme Hazard Events on Interdependent Civil Infrastructure Systems." *Design Safe Data Depot*, DesignSafe-CI, <<https://www.designsafe-ci.org/data/browser/public/designsafe.storage.published//PRJ-2158>> (Feb. 18, 2021).

- Sotres, P., Santana, J. R., Sanchez, L., Lanza, J., and Munoz, L. (2017). “Practical Lessons from the Deployment and Management of a Smart City Internet-of-Things Infrastructure: The SmartSantander Testbed Case.” *IEEE Access*, 5, 14309–14322.
- Theony, C. M. (2020). “Infrastructure readiness in the United States Space Force.” *Over the Horizon: Multidomain Operations and Strategy*.
- Thoung, C., Beaven, R., Zuo, C., Birkin, M., Tyler, P., Crawford-Brown, D., Oughton, E. J., and Kelly, S. (2016). “Future Demand for Infrastructure Services.” *The Future of National Infrastructure: A System-of-Systems Approach*, J. W. Hall, M. Tran, A. J. Hickford, and R. J. Nicholls, eds., Cambridge University Press, Cornwall.
- Turton, W., and Mehrotra, K. (2021). “Hackers Breached Colonial Pipeline Using Compromised Password.” *Bloomberg Cybersecurity*.
- U.S. Department of Energy. (2017). *Water and Wastewater Annual Price Escalation Rates for Selected Cities across the United States*.
- U.S. Energy Information Administration (EIA). (2020). “Table 1.2. Summary Statistics for the United States, 2009-2019.” *Annual Report*, <https://www.eia.gov/electricity/annual/html/epa_01_02.html> (Mar. 3, 2021).
- United States. (2017). *National Security Strategy of the United States of America*. Washington D.C.
- United States Department of Defense. (2019). *Annual Energy Management and Resilience Report (AEMRR) FY2018*.
- United States Department of Defense. (2018). *Summary of the National Defense Strategy. 2018 National Defense Strategy*.
- Valencia, V. V. (2013). “Network interdependency modeling for risk assessment on built infrastructure systems.” *ProQuest Dissertations and Theses*, 179.
- Webber, R. (2019). “Average Cell Phone Bill Now \$114 per Month.” *MoneySavingPro.com*, <<https://www.moneysavingpro.com/cell-phone-plans/comparing-us-and-uk-bills/>> (Mar. 5, 2021).
- White, R., Burkhart, A., George, R., Boulton, T., and Chow, E. (2016). “Towards comparable cross-sector risk analyses: A re-examination of the Risk Analysis and Management for Critical Asset Protection (RAMCAP) methodology.” *International Journal of Critical Infrastructure Protection*, Elsevier, 14, 28–40.

- Yan, S., and Shih, Y. L. (2009). "Optimal scheduling of emergency roadway repair and subsequent relief distribution." *Computers and Operations Research*, Pergamon, 36(6), 2049–2065.
- Yianni, P. C., Neves, L. C., Rama, D., Andrews, J. D., and Dean, R. (2016). "Incorporating local environmental factors into railway bridge asset management." *Engineering Structures*, Elsevier Ltd, 128, 362–373.
- Zhang, C., Kong, J., and Simonovic, S. P. (2018). "Restoration resource allocation model for enhancing resilience of interdependent infrastructure systems." *Safety Science*, 102, 169–177.

REPORT DOCUMENTATION PAGE

Form Approved
OMB No. 0704-0188

The public reporting burden for this collection of information is estimated to average 1 hour per response, including the time for reviewing instructions, searching existing data sources, gathering and maintaining the data needed, and completing and reviewing the collection of information. Send comments regarding this burden estimate or any other aspect of this collection of information, including suggestions for reducing the burden, to Department of Defense, Washington Headquarters Services, Directorate for Information Operations and Reports (0704-0188), 1215 Jefferson Davis Highway, Suite 1204, Arlington, VA 22202-4302. Respondents should be aware that notwithstanding any other provision of law, no person shall be subject to any penalty for failing to comply with a collection of information if it does not display a currently valid OMB control number.
PLEASE DO NOT RETURN YOUR FORM TO THE ABOVE ADDRESS.

1. REPORT DATE (DD-MM-YYYY) 16-08-2021	2. REPORT TYPE Doctoral Dissertation	3. DATES COVERED (From - To) Oct 2019 - Aug 2021
--	--	--

4. TITLE AND SUBTITLE Interdependent Infrastructure Recovery Using Multilayered Networks and Optimization	5a. CONTRACT NUMBER
	5b. GRANT NUMBER
	5c. PROGRAM ELEMENT NUMBER

6. AUTHOR(S) Moore, Brigham A, Major, USAF	5d. PROJECT NUMBER
	5e. TASK NUMBER
	5f. WORK UNIT NUMBER

7. PERFORMING ORGANIZATION NAME(S) AND ADDRESS(ES) Air Force Institute of Technology Graduate School of Engineering and Management (AFIT/EN) 2950 Hobson Way WPAFB OH 45433-7765	8. PERFORMING ORGANIZATION REPORT NUMBER AFIT-ENV-DS-21-S-077
---	---

9. SPONSORING/MONITORING AGENCY NAME(S) AND ADDRESS(ES) Intentionally left blank	10. SPONSOR/MONITOR'S ACRONYM(S)
	11. SPONSOR/MONITOR'S REPORT NUMBER(S)

12. DISTRIBUTION/AVAILABILITY STATEMENT

DISTRIBUTION STATEMENT A: APPROVED FOR PUBLIC RELEASE; DISTRIBUTION UNLIMITED.

13. SUPPLEMENTARY NOTES
This material is declared a work of the U.S. Government and is not subject to copyright protection in the United States.

14. ABSTRACT
This research presents a model which simultaneously integrates 9 interdependency subtypes and 4 coupling strategies in a time-indexed bi-objective format to provide the most tailorable and comprehensive network flow-based recovery model available. These efforts were accomplished by creating a mixed-integer program and testing them with defense-centric infrastructure datasets. The results showed that the exclusion of certain interdependencies could cost over \$4M for marginal operability improvement. Also it was shown that interdependencies can help overcome challenges with inaccessible civil infrastructure data. Lastly, integration of team management into recovery operations is possible.

15. SUBJECT TERMS
interdependent infrastructure recovery; network-based model; multi-objective optimization; resilience engineering

16. SECURITY CLASSIFICATION OF:			17. LIMITATION OF ABSTRACT	18. NUMBER OF PAGES	19a. NAME OF RESPONSIBLE PERSON
a. REPORT	b. ABSTRACT	c. THIS PAGE			David R. Jacques, AFIT/ENV
U	U	U	UU	297	19b. TELEPHONE NUMBER (Include area code) 937-255-3355 x3329; david.jacques@afit.edu

INSTRUCTIONS FOR COMPLETING SF 298

1. REPORT DATE. Full publication date, including day, month, if available. Must cite at least the year and be Year 2000 compliant, e.g. 30-06-1998; xx-06-1998; xx-xx-1998.

2. REPORT TYPE. State the type of report, such as final, technical, interim, memorandum, master's thesis, progress, quarterly, research, special, group study, etc.

3. DATE COVERED. Indicate the time during which the work was performed and the report was written, e.g., Jun 1997 - Jun 1998; 1-10 Jun 1996; May - Nov 1998; Nov 1998.

4. TITLE. Enter title and subtitle with volume number and part number, if applicable. On classified documents, enter the title classification in parentheses.

5a. CONTRACT NUMBER. Enter all contract numbers as they appear in the report, e.g. F33315-86-C-5169.

5b. GRANT NUMBER. Enter all grant numbers as they appear in the report. e.g. AFOSR-82-1234.

5c. PROGRAM ELEMENT NUMBER. Enter all program element numbers as they appear in the report, e.g. 61101A.

5e. TASK NUMBER. Enter all task numbers as they appear in the report, e.g. 05; RF0330201; T4112.

5f. WORK UNIT NUMBER. Enter all work unit numbers as they appear in the report, e.g. 001; AFAPL30480105.

6. AUTHOR(S). Enter name(s) of person(s) responsible for writing the report, performing the research, or credited with the content of the report. The form of entry is the last name, first name, middle initial, and additional qualifiers separated by commas, e.g. Smith, Richard, J, Jr.

7. PERFORMING ORGANIZATION NAME(S) AND ADDRESS(ES). Self-explanatory.

8. PERFORMING ORGANIZATION REPORT NUMBER. Enter all unique alphanumeric report numbers assigned by the performing organization, e.g. BRL-1234; AFWL-TR-85-4017-Vol-21-PT-2.

9. SPONSORING/MONITORING AGENCY NAME(S) AND ADDRESS(ES). Enter the name and address of the organization(s) financially responsible for and monitoring the work.

10. SPONSOR/MONITOR'S ACRONYM(S). Enter, if available, e.g. BRL, ARDEC, NADC.

11. SPONSOR/MONITOR'S REPORT NUMBER(S). Enter report number as assigned by the sponsoring/monitoring agency, if available, e.g. BRL-TR-829; -215.

12. DISTRIBUTION/AVAILABILITY STATEMENT. Use agency-mandated availability statements to indicate the public availability or distribution limitations of the report. If additional limitations/ restrictions or special markings are indicated, follow agency authorization procedures, e.g. RD/FRD, PROPIN, ITAR, etc. Include copyright information.

13. SUPPLEMENTARY NOTES. Enter information not included elsewhere such as: prepared in cooperation with; translation of; report supersedes; old edition number, etc.

14. ABSTRACT. A brief (approximately 200 words) factual summary of the most significant information.

15. SUBJECT TERMS. Key words or phrases identifying major concepts in the report.

16. SECURITY CLASSIFICATION. Enter security classification in accordance with security classification regulations, e.g. U, C, S, etc. If this form contains classified information, stamp classification level on the top and bottom of this page.

17. LIMITATION OF ABSTRACT. This block must be completed to assign a distribution limitation to the abstract. Enter UU (Unclassified Unlimited) or SAR (Same as Report). An entry in this block is necessary if the abstract is to be limited.